

ORDER NO.: 247  
CONTRACT ID. NO.: CM224PMF123441B

Form C-6a  
Rev. 3-22-05

CNSP (F) 1-9-06

**COMMONWEALTH OF VIRGINIA  
DEPARTMENT OF TRANSPORTATION  
BID PROPOSAL AND CONTRACT**

ROUTE NUMBER: VARIOUS

FHWA NUMBER: PM02(492)

PROJECT NUMBER: PM2F-962-F24, P401

COUNTY: HENRY, PATRICK

DISTRICT: SALEM



DESCRIPTION: SGR - 2024 PLANT MIX - PRIMARY

LOCATION: VARIOUS

DATE BID SUBMITTED: 10:00 A.M. WEDNESDAY, FEBRUARY 28, 2024

**ORDER NO.: 247**  
**CONTRACT ID. NO.: CM224PMF123441B**

Form C-118  
Rev. 7-6-05

**COMMONWEALTH OF VIRGINIA**  
**DEPARTMENT OF TRANSPORTATION**  
**NOTICE TO BIDDERS**

As a matter of information, the bidder's attention is directed to the points noted herein. Every point enumerated below is fully covered by proposal documents that describe them in detail. Bidders should check their proposal against all requirements, as strict compliance with all provisions is mandatory.

1. Bids shall be filed electronically through Bidx ([www.bidx.com/main/index.html](http://www.bidx.com/main/index.html)) at the times designated in the Notice of Advertisement for Bids. For information see (<http://cabb.virginiadot.org/cabb/>)
2. Unless otherwise specified or permitted in the proposal, prices shall be submitted on all items shown in the proposal.
3. Proposals conditioned by proposed alternates, other than those specified or permitted, or by reserving the right to accept or reject an award or to enter into a contract pursuant to an award will not be considered.
4. A bid total shall be shown in each space provided.
5. Bid bonds shall conform to Section 102.07. The bid bond number shall be placed in the appropriate space in your electronic bid. As an alternative you may complete the bottom line of the Form C-24. This form may be mailed or faxed but must be received prior to the opening of the bids.
6. Joint venture proposals shall show the Firm Name of each party and shall be signed by an authorized representative of each Firm. A letter shall be filed with the prequalification office describing responsibility of each firm and the amount of maximum capacity pledge by each firm of a joint venture.

**ORDER NO.: 247**  
**CONTRACT ID. NO.: CM224PMF123441B**

Form C-24  
Rev. 7-6-05

**COMMONWEALTH OF VIRGINIA**  
**DEPARTMENT OF TRANSPORTATION**  
**PROPOSAL GUARANTY**

KNOW ALL MEN BY THESE PRESENTS, THAT WE \_\_\_\_\_ As principal, and \_\_\_\_\_ Surety, are held and firmly bound unto the Commonwealth of Virginia as obligee, in the amount of FIVE PERCENT OF THE DOLLAR VALUE OF THE BID, lawful money of the United States of America, for the payment of which, well and truly to be made, we bind ourselves, our heirs, executors, administrators, successors and assigns, jointly and severally and firmly by these presents.

SIGNED, sealed and dated this \_\_\_\_\_ Day of \_\_\_\_\_, 20 \_\_\_\_\_

WHEREAS, the above said principal is herewith submitting its proposal for:

PROJECT NUMBER: PM2F-962-F24, P401

NOW, THEREFORE, the condition of the above obligee is such, that if the aforesaid principal shall be awarded the contract upon said proposal and shall within the time specified in the Specifications after the notice of such award enter into a contract and give bond for the faithful performance of the contract, then this obligation shall be null and void; otherwise to remain in full force and effect and the principal and surety will pay unto the obligee the difference in money between the amount of the bid of the said principal and the amount for which the obligee may legally contract with another party to perform the said work if the latter amount be in excess of the former; but in no event shall the liability exceed the penal sum hereof.

\_\_\_\_\_  
(Principal\*)

By: \_\_\_\_\_  
(Officer, Partner or Owner) (Seal)

\_\_\_\_\_  
(Surety Company)

By: \_\_\_\_\_  
(Attorney-in-Fact\*\*) (Seal)

\_\_\_\_\_  
(Principal\*)

By: \_\_\_\_\_  
(Officer, Partner or Owner) (Seal)

\_\_\_\_\_  
(Address)

By: \_\_\_\_\_  
(Surety Company)

\_\_\_\_\_  
(Principal\*)

By: \_\_\_\_\_  
(Officer, Partner or Owner) (Seal)

\_\_\_\_\_  
(Attorney-in-Fact\*\*) (Seal)

By: \_\_\_\_\_  
(Address)

\*Note: If the principal is a *joint venture*, each party thereof must be named and execution made by same hereon. If there is more than one surety to the bid bond, each surety must be named and execution shall be made by same hereon.

**Electronic Bid Only:** In lieu of completing the above section of the Contract Performance Bond, the Principal shall file an Electronic Bid Bond when bidding electronically. By signing below the Principal is ensuring the identified electronic bid bond has been executed and the Principal and Surety are firmly bound unto the Commonwealth of Virginia under the same conditions of the bid bond as shown above.

\_\_\_\_\_  
Electronic Bid Bond ID#

\_\_\_\_\_  
Company/Bidder Name

\_\_\_\_\_  
Signature and Title

\*\*Attach copy of Power of Attorney

**ORDER NO.: 247**  
**CONTRACT ID. NO.: CM224PMF123441B**

Form C-48  
Rev. 2-23-11

COMMONWEALTH OF VIRGINIA  
DEPARTMENT OF TRANSPORTATION  
**SUBCONTRACTOR/SUPPLIER SOLICITATION AND UTILIZATION FORM (ALL BIDDERS)**

PROJECT NO.: PM2F-962-F24, P401                      CONTRACT ID. NO.: CM224PMF123441B  
FHWA NO:      PM02(492)                              DATE SUBMITTED \_\_\_\_\_

**All bidders, including DBEs bidding as Prime Contractors, shall complete and submit the following information as requested in this form within ten (10) business days after the opening of bids.**

The bidder certifies this form accurately represents its solicitation and utilization or non-utilization, as indicated, of the firms listed below for performance of work on this contract. The bidder also certifies he/she has had direct contact with the named firms regarding participation on this project.

BIDDER \_\_\_\_\_ SIGNATURE \_\_\_\_\_  
TITLE \_\_\_\_\_

**SUBCONTRACTOR/SUPPLIER SOLICITATION AND UTILIZATION (ALL)**

VENDOR NUMBER	NAME OF SUBCONTRACTOR/SUPPLIER	TELEPHONE NUMBER	DBE OR NON-DBE	UTILIZED (Y/N)

**NOTE:** ATTACH ADDITIONAL PAGES, IF NECESSARY.

BIDDER MUST SIGN EACH ADDITIONAL SHEET TO CERTIFY ITS CONTENT AND COMPLETION OF FORM.

**ORDER NO.: 247  
CONTRACT ID. NO.: CM224PMF123441B**

Form C-7  
Rev. 1-19-12  
SHEET 1

**TERMS OF THE PROPOSAL\CONTRACT  
COMMONWEALTH OF VIRGINIA  
DEPARTMENT OF TRANSPORTATION**

**SUBMITTED: 10:00 A.M. WEDNESDAY, FEBRUARY 28, 2024**

PROJECT NUMBER: PM2F-962-F24, P401  
ROUTE NUMBER: VARIOUS  
FHWA NUMBER: PM02(492)  
DESCRIPTION: SGR - 2024 PLANT MIX - PRIMARY  
LOCATION: VARIOUS

DISTRICT: SALEM COUNTY: HENRY, PATRICK

I/we declare that no other person, firm or corporation is interested in this proposal; that I/we have carefully examined the plans, job specifications, current Road and Bridge specifications, and all other documents pertaining thereto and thoroughly understand the contents thereof; that I/we meet the prequalification requirements for bidding on this proposal; that I/we understand that the plans and current Road and Bridge specifications, are a part of this proposal; that all of the quantities shown herewith are a part of this proposal; that all the quantities shown herewith are approximate only; that I/we have examined the location of the proposed work and source of supply of materials; and that I/we agree to bind myself/ourselves upon award by the Commonwealth under this proposal to a contract with necessary surety bond to start work according to project specifications, and to complete all work in accordance with the plans, job specifications and current Road and Bridge Specifications within the time limit set forth in the contract.

**COMPLETION DATE: NOVEMBER 15, 2024**

BID TOTAL \$ \_\_\_\_\_

Attached is a bond conforming to the requirements of the current Road and Bridge Specifications, it being understood that such bond is to be forfeited as liquidated damages if, upon acceptance of the terms of this proposal, I/we fail to execute the contract and furnish bond as provided in the current Road and Bridge Specifications.

\_\_\_\_\_  
(Names of Individual(S), Firm(S) Or Corporation)

\_\_\_\_\_  
Street Address

\_\_\_\_\_  
City

\_\_\_\_\_  
State

\_\_\_\_\_  
Zip Code

\_\_\_\_\_  
Vendor#/Fin#

\_\_\_\_\_  
Print Name

\_\_\_\_\_  
Signature

\_\_\_\_\_  
Title

In consideration of the commitments made as shown herein, the Commonwealth of Virginia by The Commonwealth Transportation Commissioner agrees to pay for all items of work performed and materials furnished at the unit price(s) and under the conditions set forth in this proposal, in witnessed by the affixing of the name below.

Contract Execution Date \_\_\_\_\_

By \_\_\_\_\_

CHIEF ENGINEER  
VIRGINIA DEPARTMENT OF TRANSPORTATION

Proposal ID: CM224PMF123441B Oversight/State Project No.: PM2F-962-F24, P401  
 Order No.: 247 Federal Project No.: PM02(492)

Contractor: \_\_\_\_\_

SECTION: 1 REGULAR BID ITEMS

Cat Alt Set ID: Cat Alt Mbr ID:

Proposal Line Number	Spec No.	Item ID Description	Approximate Quantity and Units	Unit Price		Bid Amount	
				Dollars	Cents	Dollars	Cents
0010	ATTD	305SP20-0003 AGR. BASE MAT. TY.I OR II NO. 21A OR 21B	2,275.000 TON	_____	_____	_____	_____
0020	310	310SD20-0001 TACK COAT	47,509.000 GAL	_____	_____	_____	_____
0030	315	315SD20-0015 RUMBLE STRIP CYLINDRICAL ASPHALT	81,253.000 LF	_____	_____	_____	_____
0040	315	315SD20-0016 LIQUID ASPHALT COATING (RUMBLE STRIP)	13,547.000 SY	_____	_____	_____	_____
0050	315	315SD20-0048 ASPH. CONC. TY. BM-25.0D MAINT	9,993.130 TON	_____	_____	_____	_____
0060	ATTD	315SP20-0006 PAVEMENT SHOULDER WEDGE PREP. CONST	148,664.000 LF	_____	_____	_____	_____
0070	315	315SP20-0049 ASPH. CONC. BMD P+VO SM- 9.5D	49,426.820 TON	_____	_____	_____	_____
0080	512	512SD20-0027 FLAGGER SERVICE	1,850.000 HR	_____	_____	_____	_____
0090	512	512SD20-0046 TEMP. PVMT MRKG TY. A, 4"	288,439.000 LF	_____	_____	_____	_____
0100	512	512SD20-0047 TEMP. PVMT MRKG TY. A, 6"	288,439.000 LF	_____	_____	_____	_____
0110	512	512SD20-0048 TEMP. PVMT MRKG TY. A, 8"	2,430.000 LF	_____	_____	_____	_____
0120	512	512SD20-0049 TEMP. PVMT MRKG TY. A, 12"	2,430.000 LF	_____	_____	_____	_____
0130	ATTD	512SP20-0002 MAINTENANCE OF TRAFFIC PLANT MIX	LUMP SUM	LUMP SUM	_____	_____	_____

Proposal ID: CM224PMF123441B Oversight/State Project No.: PM2F-962-F24, P401

Order No.: 247

Federal Project No.: PM02(492)

Contractor: \_\_\_\_\_

SECTION: 1 REGULAR BID ITEMS

Cat Alt Set ID: Cat Alt Mbr ID:

Proposal Line Number	Spec No.	Item ID Description	Approximate Quantity and Units	Unit Price		Bid Amount	
				Dollars	Cents	Dollars	Cents
0140	ATTD	512SX20-0005 TEMP. PVMT MRKG TEMP. PAVE. MESS. MARK (STOP BAR 12")	987.000 LF	_____	_____	_____	_____
0150	515	515SD20-0013 FLEXIBLE PAVE.PLANING 0"-2"	419,433.320 SY	_____	_____	_____	_____
0160	515	515SD20-0015 FLEXIBLE PAVEMENT PLANING ABOVE 4"	27,766.940 SY	_____	_____	_____	_____
0170	704	704SD20-0007 TYPE B CLASS I PVMT LINE MRKG 6"	247,568.000 LF	_____	_____	_____	_____
0180	704	704SD20-0009 TYPE B CLASS I PVMT LINE MRKG 12"	2,430.000 LF	_____	_____	_____	_____
0190	704	704SD20-0015 TYPE B CLASS II PVMT LINE MRKG 24"	1,092.000 LF	_____	_____	_____	_____
0200	ATTD	704SD20-0032 INLAID PAVEMENT MARKER ASPHALT	1,274.000 EA	_____	_____	_____	_____
0210	704	704SD20-0042 PVMT MSG. MARK. R/R CROSSING TY. B, CL. II	2.000 EA	_____	_____	_____	_____
0220	704	704SD20-0048 PVMT SYMB MRKG SGL TURN ARR. TY B CL II	31.000 EA	_____	_____	_____	_____
0230	704	704SD20-0051 DBL TURN ARR.THUR/LT OR RT TY B, CL II	2.000 EA	_____	_____	_____	_____
0240	704	704SD20-0124 PVMT MSG. MARK."SCHOOL" TY B, CL II, 10'	1.000 EA	_____	_____	_____	_____

Proposal ID: CM224PMF123441B Oversight/State Project No.: PM2F-962-F24, P401  
 Order No.: 247 Federal Project No.: PM02(492)

Contractor: \_\_\_\_\_

SECTION: 1 REGULAR BID ITEMS

Cat Alt Set ID: \_\_\_\_\_ Cat Alt Mbr ID: \_\_\_\_\_

Proposal Line Number	Spec No.	Item ID Description	Approximate Quantity and Units	Unit Price		Bid Amount	
				Dollars	Cents	Dollars	Cents
0250	ATTD	704SX20-0001 PAVEMENT MARKING POLYUREA TY.B CL.VII PVMT LINE MRKG 6"	44,181.000 LF	_____	_____	_____	_____
0260	ATTD	704SX20-0001 PAVEMENT MARKING PREFORMED THERMO PAVE. LINE MARK. RUMBLE STRIPS 4"	1,050.000 LF	_____	_____	_____	_____
Section: 1				Total:	_____	_____	_____

SECTION: 2 ALTERNATE BID ITEMS

Cat Alt Set ID: \_\_\_\_\_ Cat Alt Mbr ID: \_\_\_\_\_

Proposal Line Number	Spec No.	Item ID Description	Approximate Quantity and Units	Unit Price		Bid Amount	
				Dollars	Cents	Dollars	Cents
0270	ATTD	305SX20-0006 SELECT MATERIAL ALTERNATE SHOULDER MATERIAL	1.000 TON	_____	_____	_____	_____
Section: 2				Total:	_____	_____	_____
				Total Bid:	_____	_____	_____



**Bid Items Eligible For Fuel Adjustment**

Instructions: This form shall be completed in accordance with the Special Provision for Optional Adjustment for Fuel. If you choose to have Fuel Adjustment applied to any of the items listed below, write the word "Yes" in the "OPTION" column beside the item. The form must be signed, dated, and submitted to the Contract Engineer within the timeframe required in the Special Provision.

SECTION: 1                      REGULAR BID ITEMS

Item Number	Item Description	Fuel Factor gal/unit	Option
305SP20-0003	AGR. BASE MAT. TY.I OR II NO. 21A OR 21B	0.600	_____
310SD20-0001	TACK COAT	0.016	_____
315SD20-0048	ASPH. CONC. TY. BM-25.0D MAINT	3.500	_____
315SP20-0049	ASPH. CONC. BMD P+VO SM-9.5D	3.500	_____
515SD20-0013	FLEXIBLE PAVE.PLANING 0"-2"	0.071	_____

SECTION: 2                      ALTERNATE BID ITEMS

Item Number	Item Description	Fuel Factor gal/unit	Option
-------------	------------------	----------------------	--------

Date: \_\_\_\_\_

Signature: \_\_\_\_\_

\_\_\_\_\_  
(Firm or Corporation)

\_\_\_\_\_  
(Vendor No.)

Contract ID: CM224PMF123441B

Order No.: 247

Bid Items Eligible For Asphalt Adjustment within this Project

---

SECTION: 1

REGULAR BID ITEMS

Item Number	Item Description
310SD20-0001	TACK COAT
315SD20-0016	LIQUID ASPHALT COATING (RUMBLE STRIP)
315SD20-0048	ASPH. CONC. TY. BM-25.0D MAINT
315SP20-0049	ASPH. CONC. BMD P+VO SM-9.5D

SECTION: 2

ALTERNATE BID ITEMS

Item Number	Item Description
-------------	------------------

**ORDER NO.: 247**  
**CONTRACT ID. NO.: CM224PMF123441B**

Form C-111  
Rev. 2-15-11

**COMMONWEALTH OF VIRGINIA**  
**DEPARTMENT OF TRANSPORTATION**  
**MINIMUM DBE REQUIREMENTS**

PROJECT NO: PM2F-962-F24, P401

FHWA NO: PM02(492)

**\*\*\* INSTRUCTIONS \*\*\***

THIS FORM CAN BE USED BY THE CONTRACTOR TO SUBMIT THE NAMES OF DBE FIRMS TO BE UTILIZED ON THE PROJECT. THE CONTRACTOR SHALL INDICATE THE DESCRIPTION OF THE CATEGORY (S, M, SP or H) AND THE TYPE OF WORK THAT EACH DBE WILL PERFORM AND THE ALLOWABLE CREDIT PER ITEM(S). ADDITIONAL SHEETS TO SHOW THE ALLOWABLE CREDIT PER ITEM MAY BE ATTACHED IF NECESSARY. PLEASE NOTE: THE AMOUNT OF ALLOWABLE CREDIT FOR A DBE SUPPLIER IS 60% OF THE TOTAL COST OF THE MATERIALS OR SUPPLIES OBTAINED AND 100% FOR A DBE MANUFACTURER OF THE MATERIALS AND SUPPLIES OBTAINED. A CONTRACTOR MAY COUNT 100% OF THE FEES PAID TO A DBE HAULER FOR THE DELIVERY OF MATERIALS AND SUPPLIES TO THE PROJECT SITE, BUT NOT FOR THE COST OF THE MATERIALS AND SUPPLIES THEMSELVES.

**SECTION I:**

DBE REQUIREMENT 4.00%

**SECTION II:**

PERCENT ATTAINED BY BIDDER           %

NAME(s) AND CERTIFICATION NO. OF DBE(s) TO BE USED	USED AS SUBCONTR. (S) MFG. (M) SUPPLIER (SP) HAULER (H)	TYPE OF WORK & ITEM NO(s)	AMT. OF ALLOWABLE CREDIT PER ITEM

TOTAL: \$ \_\_\_\_\_

Total Contract Value \$ \_\_\_\_\_ X Required DBE \_\_\_\_\_ % = \$ \_\_\_\_\_

I/WE CERTIFY THAT THE PROPOSED DBE (S) SUBMITTED WILL BE USED ON THIS CONTRACT AS STATED HEREON AND ASSURE THAT DURING THE LIFE OF THE CONTRACT, I/WE WILL MEET OR EXCEED THE PARTICIPATION ESTABLISHED HEREON BY THE DEPARTMENT.

\_\_\_\_\_ By \_\_\_\_\_  
BIDDER SIGNATURE

\_\_\_\_\_ By \_\_\_\_\_  
TITLE DATE

**ORDER NO.: 247  
CONTRACT ID. NO.: CM224PMF123441B**

Form C-112  
Rev. 3-1-11  
Page 1 of 2

**COMMONWEALTH OF VIRGINIA  
DEPARTMENT OF TRANSPORTATION  
CERTIFICATION OF BINDING AGREEMENT WITH  
DISADVANTAGED BUSINESS ENTERPRISE FIRMS**

Project No.: PM2F-962-F24, P401

FHWA NO: PM02(492)

This form is to be submitted in accordance with the Department's Special Provision for Section 107.15.

It is hereby certified by the below signed Contractors that there exists a written quote, acceptable to the parties involved preliminary to a binding subcontract agreement stating the details concerning the work to be performed and the price which will be paid for the aforementioned work. This document is not intended to, nor should it be construed to, contain the entire text of the agreement between the contracting parties. This document does not take the place of, nor may it be substituted for, an official subcontracting agreement in those situations that may require such an agreement. A copy of the fully executed *subcontract agreement* shall be submitted to the Engineer within fourteen (14) working days after contract execution.

It is further certified that the aforementioned mutually acceptable quote and fully executed subcontract agreement represent the entire agreement between the two parties involved and that no conversations, verbal agreements, or other forms of non-written representations shall serve to add to, delete, or modify the terms as stated.

The prime Contractor further represents that the aforementioned mutually acceptable quote and fully executed subcontract agreement shall remain on file for a period of not less than one year following completion of the prime's contract with the Department or for such longer period as provisions of governing Federal or State law or regulations may require. For purposes of this form, the term Prime Contractor shall refer to any Contractor utilizing a DBE subcontractor, regardless of tier, in which they are claiming DBE credit toward the contract goal.

Contractors further jointly and severally represent that said binding agreement is for the performance of a "commercially useful function" as that term is employed in 49 C.F.R. Part 26.55 (c), (d).

**TO BE SIGNED BY THE SUBCONTRACTOR TO THE PRIME CONTRACTOR, AND ANY LOWER TIER  
SUBCONTRACTORS HAVING A CONTRACT WITH THE BELOW NAMED DBE FIRM**

Prime Contractor: \_\_\_\_\_

By: \_\_\_\_\_  
Signature Title

Date: \_\_\_\_\_

First Tier  
Subcontractor  
If Applicable:

By: \_\_\_\_\_  
Signature Title

Date: \_\_\_\_\_

**ORDER NO.: 247**  
**CONTRACT ID. NO.: CM224PMF123441B**

Form C-112  
Rev. 3-1-11  
Page 2 of 2

Second Tier  
Subcontractor  
If Applicable:

---

By: \_\_\_\_\_  
Signature Title  
Date: \_\_\_\_\_

Third Tier  
Subcontractor  
If Applicable

---

By: \_\_\_\_\_  
Signature Title  
Date: \_\_\_\_\_

DBE Contractor

---

By: \_\_\_\_\_  
Signature Title  
Date: \_\_\_\_\_

**ORDER NO.: 247**  
**CONTRACT ID. NO.: CM224PMF123441B**

**TABLE OF CONTENTS FOR PROVISIONS**

**FORMS and SCHEDULE OF ITEMS PRECEDE SPCNs, SPs and SUPPLEMENTAL SPECS.**

<b>*CN100-000026-08</b>	<b>GEN. PROJ. REQUIRE., SSS/SPS/SPCNS</b>	<b>4-4-22 (SPCN)</b>	<b>1</b>
<b>CN102-000100-01</b>	<b>ALT. CAT. BID ITEM AND AWARD OF CONTRACT</b>	<b>7-13-16 (SPCN)</b>	<b>1</b>
<b>CN104-000110-00</b>	<b>SEC. 104.01—INTENT OF CONTRACT</b>	<b>R-7-12-16 (SPCN)</b>	<b>2</b>
<b>CN107-002110-01</b>	<b>SEC. 107.21(D) CONST. LOADING OF STRUCT.</b>	<b>10-30-17 (SPCN)</b>	<b>3</b>
<b>CN108-000110-00</b>	<b>SEC. 108.01—PROSECUTION OF WORK</b>	<b>R-7-12-16 (SPCN)</b>	<b>3</b>
<b>CN211-000100-00</b>	<b>POLISHING AGGREGATE IN ASPHALT CONC.</b>	<b>R-7-12-16 (SPCN)</b>	<b>3</b>
<b>CN315-000100-00</b>	<b>SEC. 315.05(C) PLACING AND FINISHING</b>	<b>1-18-17 (SPCN)</b>	<b>4</b>
<b>CN510-000100-00</b>	<b>LOCATE/REPLACE PAVEMENT MARKERS</b>	<b>R-7-12-16 (SPCN)</b>	<b>5</b>
<b>CN512-000100-00</b>	<b>TABLE V-1, ADT GROUPS</b>	<b>7-12-16 (SPCN)</b>	<b>5</b>
<b>CN512-000120-00</b>	<b>SEC. 512—MAINTAINING TRAFFIC (IMPACT ATTEN. SER.)</b>	<b>7-13-16_(SPCN)</b>	<b>5</b>
<b>CN515-000100-02</b>	<b>DISINCENTIVE FOR PLANING IN MULTIPLE LANES</b>	<b>11-23-16 (SPCN)</b>	<b>5</b>
<b>*DRUG-FREE WORKPLACE</b>		<b>7-3-19 (SPCN)</b>	<b>6</b>
<b>CQ107-000150-00</b>	<b>EQUAL EMPLOYMENT OPPORTUNITY</b>	<b>5-11-22</b>	<b>7</b>
<b>*SECTION 108.02—LIMITATIONS OF OPERATIONS (RAILWAY R/W)</b>		<b>9-10-18 (SPCN)</b>	<b>7</b>
<b>CN704-000200-00</b>	<b>INLAID PAVE. MARKER LOC. AND SPACING</b>	<b>8-11-21 (SPCN)</b>	<b>8</b>
<b>AGGREGATE BASE MATERIAL TYPE I OR II NO. 21A OR 21B</b>		<b>4-24-20 (SPCN)</b>	<b>8</b>
<b>SM-9.5 SUPERPAVE ASPHALT</b>		<b>8-29-23 (SPCN)</b>	<b>8</b>
<b>SECTION 108.02 LIMITATION OF OPERATIONS</b>		<b>8-8-23 (SPCN)</b>	<b>9</b>
<b>SP0F0-000100-00</b>	<b>PREDETERMINED MIN. WAGE RATES</b>	<b>R-7-12-16</b>	<b>10</b>
<b>SP0F0-000130-02</b>	<b>FHWA 1273—REQ. PROVISIONS, FED-AID</b>	<b>10-3-23</b>	<b>23</b>
<b>SP0F0-000150-01</b>	<b>AFFIRMATIVE ACTION / EEO NOTICE</b>	<b>7-17-17</b>	<b>49</b>
<b>SP102-000120-00</b>	<b>NON-DISCRIMIN. EMPLOY. &amp; CONTRACT. PRACTICES (EO-61)</b>	<b>1-10-17</b>	<b>55</b>
<b>SP105-000100-00</b>	<b>INFORMAL PARTNERING</b>	<b>R-7-12-16</b>	<b>56</b>
<b>*SP107-000120-00</b>	<b>ELEC. SUBMISSION OF DBE AND PAYROLLS</b>	<b>1-21-20</b>	<b>58</b>
<b>SP107-001510-02</b>	<b>SEC. 107.15 (DBES)</b>	<b>8-18-17</b>	<b>60</b>
<b>*SP109-000100-04</b>	<b>ASPHALT MATERIAL PRICE ADJUSTMENT</b>	<b>6-29-23</b>	<b>79</b>
<b>SP109-000110-00</b>	<b>OPTIONAL ADJUSTMENT FOR FUEL</b>	<b>R-7-12-16</b>	<b>80</b>
<b>SP109-000130-00</b>	<b>ELECTRONIC WEIGH TICKETS</b>	<b>10-10-19</b>	<b>82</b>
<b>SP208-000100-00</b>	<b>SEC. 208—SUBBASE &amp; AGGR. BASE MATERIAL (CHCC)</b>	<b>7-12-16</b>	<b>84</b>
<b>*SP211-000100-02</b>	<b>SEC. 211—ASPHALT CONCRETE</b>	<b>3-28-22</b>	<b>86</b>
<b>SP305-000100-01</b>	<b>SHOULDER RENOVATION</b>	<b>10-3-16</b>	<b>87</b>
<b>SP305-000110-00</b>	<b>STABILIZED/PAVED SHOULDER OVERLAY</b>	<b>R-7-12-16</b>	<b>91</b>
<b>SP315-000710-01</b>	<b>RIDEABILITY (FOR ASPHALT CONCRETE PAVE.)</b>	<b>8-3-17</b>	<b>93</b>
<b>SP315-000320-01</b>	<b>PAVEMENT SHOULDER WEDGE</b>	<b>9-16-19</b>	<b>97</b>
<b>SP512-000120-04</b>	<b>SEC. 512—MAINTAINING TRAFFIC</b>	<b>6-12-23</b>	<b>101</b>
<b>SP515-000100-00</b>	<b>COLD PLANE (MILL) ASPHALT CONC. OPERATIONS</b>	<b>7-12-16</b>	<b>105</b>
<b>*SP704-000100-06</b>	<b>SEC. 704—PAVEMENT MARKINGS AND MARKERS</b>	<b>6-12-23</b>	<b>110</b>
<b>*SP704-000120-00</b>	<b>INLAID PAVEMENT MARKERS</b>	<b>8-26-19</b>	<b>126</b>
<b>SP801-000100-01</b>	<b>LANE CLOSE COORD (LCC)/LANE CLOSE IMPLEMENT (LCI)</b>	<b>9-20-17</b>	<b>129</b>
<b>PUBLIC NOTICE OF PARKING RESTRICTIONS (PLANT MIX)</b>		<b>R-7-12-16</b>	<b>131</b>
<b>SEC. 105.03—PROJ. COMMUNICATION &amp; DECISIONS (ASP. SCHED. ONLY)</b>		<b>10-7-16</b>	<b>135</b>
<b>SEC. 105.06—SUBCONTRACTING (FEDERAL FUNDED PROJECTS)</b>		<b>2-9-17_(SP)</b>	<b>137</b>
<b>SQ107-001300-00</b>	<b>PREVAILING WAGE RATES</b>	<b>10-12-2023</b>	<b>138</b>
<b>SQ315-000200-24</b>	<b>BALANCED MIX DESIGN DESIGNED USING PERFORMANCE CRITERIA</b>	<b>4-24-23</b>	<b>142</b>
<b>SQ704-000110-00</b>	<b>PAVEMENT MARKINGS AND MARKERS (DATA LOGGER SYSTEM)</b>	<b>9-25-20</b>	<b>146</b>
<b>SS109-002020-01</b>	<b>SEC. 109—MEASUREMENT AND PAYMENT</b>	<b>5-1-23</b>	<b>148</b>
<b>*SS211-002020-02</b>	<b>SECT 211 – ASPHALT CONCRETE</b>	<b>5-15-23</b>	<b>151</b>

**ORDER NO.: 247**  
**CONTRACT ID. NO.: CM224PMF123441B**

*SS220-002020-01	SEC. 220 – CONCRETE CURING MATERIALS	8-28-20	156
	SECTION 223 – STEEL REINFORCEMENT	04/04/2023	157
*SS234-002020-01	SECTION 234 – GLASS BEADS AND RETROREFLECTIVE OPTICS	5-6-22	158
*SS235-002020-01	SECTION 235 – RETROREFLECTORS	5-6-22	159
SS236-002020-01	SECTION 236 – WOOD PRODUCTS	5-14-21	160
*SS246-002020-02	SECTION 246 – PAVEMENT MARKING	5-6-22	164
	SECTION 248 – STONE MATRIX ASPHALT CONCRETE	5-26-23	172
SS315-002020-04	SECTION 315 – ASPHALT CONCRETE PLACEMENT	6-16-23	174
SS321-002020-02	SECTION 321 – TRENCH WIDENING	4-4-23	192
*SS512-002020-03	SECTION 512 – MAINTAINING TRAFFIC	7-1-22	194
*SS704-002020-02	SECTION 704 – PAVEMENT MARKINGS AND MARKERS	5-6-22	208
	NO PLAN ASSEMBLY		214

**ORDER NO.: 247**  
**CONTRACT ID. NO.: CM224PMF123441B**

cn100-000026-08

**GENERAL PROJECT REQUIREMENTS, SUPPLEMENTAL SPECIFICATIONS (SSs), SPECIAL PROVISIONS (SPs) AND SPECIAL PROVISION COPIED NOTES (SPCNs)**

This project shall be constructed according to: the plans; the *Virginia Department of Transportation Road and Bridge Specifications*, dated 2020 and the Supplement thereto, dated 2022; the *Virginia Department of Transportation Road and Bridge Standards*, dated 2016, with revisions issued online as of the advertisement date for this project incorporated; the 2011 edition of the *Virginia Work Area Protection Manual with Revision Number 2.1* incorporated, dated November 1, 2020; the 2009 edition of the *MUTCD with Revision Numbers 1 and 2* incorporated, dated May 2012; and the 2011 edition of the *Virginia Supplement to the MUTCD with Revision Number 1* dated September 30, 2013; and the Supplemental Specifications, Special Provisions and Special Provision Copied Notes in this contract. The status in the Contract of each of these documents will be according to Section 105.12 of the Specifications.

Special Provision Copied Notes in this contract are designated with "(SPCN)" after the date.

The information at the top and left of each Special Provision Copied Note in this contract is file reference information for Department use only. The information in the upper left corner above the title of each Supplemental Specification and Special Provision in this contract is file reference information for Department use only.

4-4-22 (SPCN)

[cn102-000100-01](#)

**ALTERNATE CATEGORY BID ITEM AND AWARD OF CONTRACT**

The Bidders' attention is directed to the division of the Schedule of Bid Items into two sections, Section 0001 and Section 0002. The description of these two sections is as follows:

**Section 0001**

**Base Bid** - Standard Items required for the construction of the work listed in these schedules.

**Section 0002**

**Alternate Category "A" Bid Item** –Shoulder Maintenance Material\*\* for possible use in **SHOULDER RENOVATION** work in these schedules

Bidders shall furnish prices on all bid items in Section 0001, and may also supply a price for the bid item in Section 0002. The award of the contract will be made to the responsive and responsible bidder submitting the lowest Base Bid for Section 0001. If the Contractor has also supplied a price for Section 0002, then the Department, with the concurrence of the Contractor, may allow the use of Shoulder Maintenance Material for shoulder renovation in lieu of, or in addition to, the graded Aggregate Material specified in Section 0001. Any use of the Shoulder Maintenance Material or a combination blend must be



**ORDER NO.: 247**  
**CONTRACT ID. NO.: CM224PMF123441B**

approved for use by the Engineer before Shoulder Renovation operations begin; however, such approval is conditional, and its continued use based on successful performance in the field as determined by the Engineer. In the event the Shoulder Maintenance Material in Section 0002 is not approved for use, or no price for Shoulder Maintenance Material was included in the bid, the Contractor shall use the specified Aggregate Base Material for shoulder renovation work at the price provided in the Base Bid in Section 0001.

In the event the use of Shoulder Maintenance Material is permitted by the Engineer for Shoulder Renovation operations and results in the field prove unacceptable to the Department or the Contractor, the permission for its continued use will be withdrawn, and the Contractor shall use the specified Aggregate Base Material at the price provided in the Base Bid in Section 0001.

The award of the Contract will be in accordance with Section 103.02 of the Specifications except as amended herein.

\*\* Shoulder Maintenance Material shall be as specified in [Special Provision for Shoulder Renovation](#) (10-3-16) **Note:** The use of [CHCC](#) or any CHCC blended material as Shoulder Maintenance Material will only be permitted in areas meeting the following conditions: No more than 3 feet in width and no more than 3 inches in compacted depth once placed.

7-13-16 (SPCN)

[cn104-000110-00](#)

**SECTION 104.01—INTENT OF CONTRACT** of the Specifications is replaced by the following:

The intent of the Contract is to provide for the completion of all work specified therein.

The Contractor shall base his bid on the cost of completing all work specified in the Contract.

Budgetary constraints as deemed necessary by the Department may be imposed at any time during the life of the Contract. This may affect the number of routes paved and thus the final quantity of work to be performed.

If prior to initiating or during the performance of the work, the Engineer determines that the cost of completion of all work specified in the Contract will exceed the limits of the budgeted funds, the Contractor will be notified immediately. With such notice the Engineer will specify which routes will be deleted according to the Department's predetermined listing of priorities.

If after routes are deleted and work proceeds, budgets revisions indicate that the cost of work to be completed by the Contractor will fall below the limits of the budgeted funds, the Department will determine which of the previously deleted routes will be returned to the Schedule to be completed at the contract unit price.

10-21-08; Reissued 7-12-16 (SPCN) [\[formerly cn104-010100-00\]](#)

**ORDER NO.: 247**  
**CONTRACT ID. NO.: CM224PMF123441B**

[cn107-002110-01](#)

**SECTION 107.21(d) CONSTRUCTION LOADING OF STRUCTURES** of the Specifications is replaced with the following:

- (d) **Construction Loading of Structures:** In the course of planning and prosecuting the work for the asphalt maintenance schedules in the Contract, the Contractor shall consider the size and weight limitation of any existing structure(s) affecting the prosecuting the work in a schedule when contemplating construction loads, equipment access, haul and delivery routes of materials, and other related activities. If the size or weight limitation of an existing structure changes after the receipt of bid date for the Contract and remains so up to and including the actual prosecution of work for a schedule in the Contract, preventing or limiting access across the structure, and the Contractor determines this limitation impacts his operations; he shall notify the Engineer of such change. If the Engineer confirms such change has occurred, the change will be considered a change to the character of the work according to the provisions of [Section 104.02\(b\)](#) of the Specifications and is eligible for adjustments according to the provisions therein.

10-30-17 (SPCN) [\[formerly cn107-210100-01\]](#)

[cn108-000110-00](#)

**SECTION 108.01—PROSECUTION OF WORK** is amended to add the following:

Once the Contractor has begun work on a given schedule or portion thereof he shall endeavor to prosecute such work fully and continuously according to the details and requirements of the Contract to its completion. In the event the Contractor has to temporarily suspend the work on a given schedule or portion thereof he shall notify the Engineer at least 24 hours in advance of the time and date he plans to pull off the work site. Prior to leaving the work site, the Contractor shall ensure the work site has been properly and safely secured to protect the traveling public according to the provisions of the *Virginia Work Area Protection Manual*, the *MUTCD*, Section 512 of the Specifications, and other requirements included in the Contract.

8-17-10; Reissued 7-12-16 (SPCN) [\[formerly cn108-010100-00\]](#)

[cn211-000100-00](#)

**POLISHING AGGREGATE IN ASPHALT CONCRETE - Section 211—Asphalt Concrete** of the Specifications is amended as follows:

**Section 211.02—Materials** is amended by replacing (e) with the following:

Fine or coarse aggregate that tend to polish under traffic will not be permitted in any final surface exposed to traffic except as permitted within the limits of Section 211.04(a) and (b) of the Specifications and as designated by the Engineer or as permitted elsewhere in these Specifications.

**Section 211.04—Asphalt Concrete Mixtures** is amended by replacing (a) and (b) with the following:

Asphalt concrete mixtures shall conform to Table II-14 and the following:

**ORDER NO.: 247**  
**CONTRACT ID. NO.: CM224PMF123441B**

- (a) **Types SM-9.0A, SM-9.0D, SM-9.0E, SM-9.5A, SM-9.5D and SM-9.5E asphalt concrete** shall consist of crushed stone, crushed slag, or crushed gravel and fine aggregate, slag or stone screenings or a combination thereof combined with asphalt cement.

**NOTE:** For all surface mixes, except where otherwise noted, no more than 5 percent of all aggregate retained on the No. 4 sieve and no more than 20 percent of the total aggregate may be polish susceptible. At the discretion of the Engineer, a SM-9.5AL may be specified and polish susceptible aggregates may be used (without percentage limits).

- (b) **Types SM-12.5A, SM-12.5D, SM-12.5E, IM-19.0A, IM-19.0D, and IM-19.0E asphalt concrete** shall consist of crushed stone, crushed slag, or crushed gravel and fine aggregate, slag or stone screenings or a combination thereof combined with asphalt cement.

**NOTE:** At the discretion of the Engineer, an intermediate mix may be designated as either a SM-19.0A or SM-19.0D. For SM-12.5 and SM-19.0 surface mixes, no more than 5 percent of the aggregate retained on the No. 4 sieve may be polish susceptible. All material passing the No. 4 sieve may be polish susceptible. No more than 35 percent of the total aggregate composition (polish and non-polish susceptible) shall be passing the No. 8 sieve. At the discretion of the Engineer, a SM-12.5AL may be specified and polish susceptible aggregates may be used (without percentage limits).

10-7-09; Reissued 7-12-16 (SPCN)

[cn315-000100-00](#)

**SECTION 315.05(c) PLACING AND FINISHING** is modified by replacing the third paragraph with the following:

The longitudinal joint in one layer shall offset that in the layer immediately below by approximately 6 inches or more. The joint in the wearing surface shall be offset 6 inches to 12 inches from the centerline of the pavement if the roadway comprises two traffic lanes. The joint shall be offset approximately 6 inches from the lane lines if the roadway is more than two lanes in width. The longitudinal joint shall be uniform in appearance. On all roads except secondary routes, if the offset for the longitudinal joint varies from a straight line more than 2 inches in 50 feet on tangent alignment, or from a true arc more than 2 inches in 50 feet on curved alignment, the Contractor shall seal the joint using a water-proof sealer at no cost to the Department. The Contractor shall recommend a sealant and installation procedure to the Engineer for approval before proceeding. On all roads except secondary routes, if the offset for the longitudinal joint varies from a straight line more than 3 inches in 50 feet on tangent alignment, or from a true arc more than 3 inches in 50 feet on curved alignment, the Engineer may reject the paving. The Engineer will not require offsetting layers when adjoining lanes are paved in echelon and the rolling of both lanes occurs within 15 minutes after laydown.

1-18-17 (SPCN)

**ORDER NO.: 247**  
**CONTRACT ID. NO.: CM224PMF123441B**

[cn510-000100-00](#)

**LOCATING, REMOVING AND DISPOSING OF RECESSED PAVEMENT MARKERS AND RAISED SNOW-PLOWABLE MARKERS** — The Contractor shall locate, remove and dispose of existing recessed pavement markers and raised snow-plowable markers prior to resurfacing. The cavity left by the removal of the existing recessed pavement markers shall be cleaned of debris, filled with the approved mix for resurfacing and compacted. Locating, removing and disposing of recessed pavement markers and raised snow-plowable markers; cleaning and filling the cavity, and compacting the material placed in the cleaned cavity will not be measured for payment. The cost for performing this work shall be included in the price bid for other appropriate items of work.

10-17-10; Reissued 7-12-16 (SPCN)

[cn512-000100-00](#)

**TABLE V-1, ADT GROUPS** — The Specifications are amended to include the following table:

**TABLE V-1**  
**Average Daily Traffic (ADT) Groups**

Traffic Group	ADT	Traffic Group	ADT
I	0-9	X	2,000-2,999
II	10-24	XI	3,000-3,999
III	25-49	XII	4,000-4,999
IV	50-99	XIII	5,000-5,999
V	100-249	XIV	6,000-9,999
VI	250-399	XV	10,000-14,999
VII	400-749	XVI	15,000-19,999
VIII	750-999	XVII	20,000-29,999
IX	1,000-1,999	XVIII	30,000-39,999
		XIX	40,000 & over

7-12-16 (SPCN)

[cn512-000120-00](#)

**SECTION 512—MAINTAINING TRAFFIC** of the Specifications is amended as follows:

**Section 512.03(i)—Impact Attenuator Service** is amended to replace the second paragraph with the following:

Only Type 1 re-directive low-maintenance impact attenuators in accordance with Section 505 shall be used on highways with posted speed limits greater than 50 mph or with an ADT greater than 25,000 vehicles per day.

7-13-16\_(SPCN)

[cn515-000100-02](#)

**DISINCENTIVE FOR PLANING IN MULTIPLE LANES**

The Special Provision for **COLD PLANING (MILLING) ASPHALT CONCRETE OPERATIONS** "[SP515-000100-00](#)" dated July 12, 2016 is amended as follows:

**Section III.A.1. Regular planing and performance planing in multiple lanes** is amended to replace the first bulleted subparagraph of the fourth paragraph with the following:

**ORDER NO.: 247**  
**CONTRACT ID. NO.: CM224PMF123441B**

- The Contractor will be limited in the case of **regular pavement planing**, whether in a single lane or multiple lane operation, to only that amount of pavement that can be paved back within 24 hours of completion of planing that roadway or portion of roadway. Single-lift operations must be restored to final elevation to satisfy this requirement. If the Contractor elects not to pave back the planed travel lanes within 24 hours from the end of the regular planing operation, or is prevented from doing so by predictable weather, the Department will assess a disincentive in the amount of **\$5,000** for each calendar day the planed travel lane surface is not paved back, including Sundays and Holidays.

**Section III.A.1. Regular planing and performance planing in multiple lanes** is amended to replace the first bulleted subparagraph of the fifth paragraph with the following:

- **Performance pavement planing** may be performed in multiple lanes across the entire widths of the lanes up 4 miles of travel lane unless otherwise stated in the Contract. Performance planed travel lane surfaces must be paved back within 96 hours from the end of the performance planing operation. Single-lift operations must be restored to final elevation to satisfy this requirement. If the Contractor elects not to pave back the planed travel lanes within 96 hours from the end of the performance planing operation, or is prevented from doing so by predictable weather, the Department will assess a disincentive in the amount of **\$5,000** for each calendar day the planed travel lane surface is not paved back, including Sundays and Holidays.

11-23-16 (SPCN)

**DRUG-FREE WORKPLACE**– The Contractor shall:

- Provide a Drug-Free Workplace for the Contractor’s employees.
- Post in conspicuous places, available to employees and applicants for employment, a statement notifying employees that the unlawful manufacture, sale, distribution, dispensation, possession, or use of a controlled substance or marijuana is prohibited in the Contractor’s workplace and specifying the actions that will be taken against employees for violations of such prohibition.
- State in all solicitations or advertisements for employees placed by or on behalf of the Contractor that the Contractor maintains a Drug-Free Workplace.
- Include the provisions of the foregoing clauses in every Subcontract or purchase order of over \$10,000, so that the provisions will be binding upon each Subcontractor or vendor.

For the purposes of this provision, “Drug-Free Workplace” means a site for the performance of work done in connection with the Contract. The Contractor’s employees, and those of his Subcontractors, shall be prohibited from engaging in the unlawful manufacture, sale, distribution, dispensation, possession, or use of any controlled substance or marijuana during the performance of the Work.

7-3-19 (SPCN)

**ORDER NO.: 247**  
**CONTRACT ID. NO.: CM224PMF123441B**

**cq107-000150-00**

**EQUAL EMPLOYMENT OPPORTUNITY**

**Section 107.14(a)1 – Required by §2.2-4201 and §2.2-4311 of the Code of Virginia** is replaced with the following:

1. **Required by §2.2-4201 and §2.2-4311 of the Code of Virginia:** During the performance of this Contract, the Contractor agrees as follows:
  - a. The Contractor shall not discriminate against any employee or applicant for employment because of race, religion, color, sex, or national origin, age, disability, or other basis prohibited by state law relating to discrimination in employment, except where religion, sex, or national origin is a bona fide occupational qualification reasonably necessary to the normal operation of the Contractor. The Contractor agrees to post in conspicuous places, available to employees and applicants for employment, notices setting forth the provisions of this nondiscrimination clause, including the names of all contracting agencies with which the Contractor has contracts of over \$10,000.
  - b. The Contractor shall, in all solicitations or advertisements for employees placed by or on behalf of the Contractor, state that such contractor is an equal opportunity employer. However, notices, advertisements and solicitations placed in accordance with federal law, rule or regulation shall be deemed sufficient for the purpose of meeting the requirements of this chapter.
  - c. If the Contractor employs more than five employees, the Contractor shall (i) provide annual training on the Contractor's sexual harassment policy to all supervisors and employees providing services in the Commonwealth, except such supervisors or employees that are required to complete sexual harassment training provided by the Department of Human Resource Management, and (ii) post the Contractor's sexual harassment policy in (a) a conspicuous public place in each building located in the Commonwealth that the Contractor owns or leases for business purposes and (b) the Contractor's employee handbook.

The Contractor shall include the provisions of subdivisions a, b, and c in every subcontract or purchase order of over \$10,000, so that such provisions shall be binding upon each subcontractor or vendor.

Nothing contained in this chapter shall be deemed to empower any agency to require any contractor to grant preferential treatment to, or discriminate against, any individual or any group because of race, color, religion, sex, or national origin on account of an imbalance that may exist with respect to the total number or percentage of persons of any race, color, religion, sex, or national origin employed by such contractor in comparison with the total number or percentage of persons of such race, color, religion, sex, or national origin in any community or in the Commonwealth.

5-11-22 (SPCN)

**SECTION 108.02—LIMITATION OF OPERATIONS** of the Specifications is amended to include the following:

- (c) **Railway right-of-way**

**ORDER NO.: 247**  
**CONTRACT ID. NO.: CM224PMF123441B**

The Contractor shall not perform work within 10 feet of Railway right-of-way until the Engineer notifies the Contractor in writing that a Right of Entry or Railroad Agreement between the Department and the CSXT, Buckingham Branch or Norfolk Southern for work within the temporary and permanent easements is executed. Performing work within 10 feet of Railway right-of-way will result in the Engineer suspending work in accordance with Section 105.03 of the Specifications. Such suspension of work will not be considered a valid reason for extending the contract time limit or for additional compensation.

9-10-18 (SPCN)

[cn704-000200-00](#)

**INLAID PAVEMENT MARKER LOCATION AND SPACING** — The Contractor shall not install markers on existing bridge decks. Inlaid Pavement Markers shall be installed on new bridge decks where required by the Plans. Inlaid Pavement Markers shall be placed in relation to pavement joints and cracks as follows:

- In existing Asphalt Concrete pavement, new or existing Hydraulic Cement Concrete pavement, and bridge decks, the edge of the groove shall be at least 2 inches from pavement joints and cracks, ensuring that the finished line of markers is straight in accordance with the tolerance for pavement markings specified in Section 704.03 of the Specifications. Offset from the longitudinal joint shall take precedence over straightness of the line of markers.
- In new Hydraulic Cement Concrete pavement or when installed in conjunction with new latex modified microsurfacing or slurry seal treatments, the edge of the groove shall be 2 inches minimum from the surface course pavement joint and 1 inch maximum off alignment from the corresponding pavement marking line. The finished line of markers shall be straight in accordance with the tolerance for pavement markings specified in Section 704.03 of the Specifications. Straightness of the line of markers and alignment with the corresponding pavement marking line takes precedence over offset from the surface course joint.

8-11-21

**AGGREGATE BASE MATERIAL TYPE I OR II NO. 21A OR 21B** will be measured in tons and will be paid for at the Contract ton price. This price shall include furnishing, hauling, placing, manipulating and compacting the material.

Payment will be made under:

<b>Pay Item</b>	<b>Pay Unit</b>
Aggregate Base Material (Type and No.)	Ton

4-24-20 (SPCN)

**SM-9.5 SUPERPAVE ASPHALT** — shall be placed in accordance with Section 315.05(c) of the Specifications, except SM-9.5 SUPERPAVE asphalt may be placed at a thickness up to 50 mm, in accordance with the Contract or as directed by the Engineer.

8-29-23 (SPCN)

**ORDER NO.: 247**  
**CONTRACT ID. NO.: CM224PMF123441B**

**SECTION 108.02 LIMITATION OF OPERATIONS**—of the Specifications is amended to include the following:

The Contractor may conduct lane closures as allowed in the Transportation Management Plan (TMP) and in the notes provided in the “Schedule” of work items found elsewhere in the Contract.

If the allocated time limits are exceeded and the Contractor fails to restore all traffic for **two (2) lanes in each direction**, a User Fee will be assessed. The User Fees for failure to restore two (2) lanes to traffic by the designated time will be assessed at the rate of **\$500 per 15 minutes in Montgomery County, Roanoke County, Carroll County, Botetourt County, and Pulaski County**. Partial 15 minute periods will also be assessed at the full rate of \$500. These fees will be deducted from the next monthly progress estimate.

For the purpose of this provision restoration of traffic shall mean placing back an asphalt surface meeting the requirements of the specifications with less than a 2” drop off in the open lane with center line and edge line pavement markings, the opening of the lane to traffic, the removal or relocation of work zone traffic control devices and signs to their approved site as determined by the Engineer, and removal of all workers, materials and equipment from the opened lane of traffic.

The fees are imposed, not as a penalty, but in order to minimize the impact of lane closures and construction operations on roadway users. The fee amount is based on daily road user costs, which are defined as representing the hourly cost of interference and inconvenience to the road user.

The Contractor waives any defense as to the validity of any fees stated in the Contract, the Contract Documents or these Specifications and assessed by the Department against the Contractor on the grounds that such fees are void as penalties or are not reasonably related to actual damages.

Any liquidated damages assessed in accordance with Section 108.06 of the Specifications will be in addition to any fees assessed as shown herein.

8-8-23 (SPCN)



**ORDER NO.: 247**  
**CONTRACT ID. NO.: CM224PMF123441B**

[SP0F0-000100-00](#)

Reissued July 12, 2016

**PREDETERMINED MINIMUM WAGE RATES**

"General Decision Number: VA20240074 01/05/2024

Superseded General Decision Number: VA20230074

State: Virginia

Construction Type: Highway

Counties: Henry and Martinsville\* Counties in Virginia.

\*including the independent city of Martinsville

HIGHWAY CONSTRUCTION PROJECTS (excluding tunnels, building structures in rest area projects & railroad construction; bascule, suspension & spandrel arch bridges designed for commercial navigation, bridges involving marine construction; and other major bridges).

Note: Contracts subject to the Davis-Bacon Act are generally required to pay at least the applicable minimum wage rate required under Executive Order 14026 or Executive Order 13658. Please note that these Executive Orders apply to covered contracts entered into by the federal government that are subject to the Davis-Bacon Act itself, but do not apply to contracts subject only to the Davis-Bacon Related Acts, including those set forth at 29 CFR 5.1(a)(1).

If the contract is entered  into on or after January 30,  2022, or the contract is  renewed or extended (e.g., an  option is exercised) on or  after January 30, 2022:         	. Executive Order 14026  generally applies to the  contract.  . The contractor must pay  all covered workers at  least \$17.20 per hour (or  the applicable wage rate  listed on this wage  determination, if it is  higher) for all hours  spent performing on the  contract in 2024.	       
If the contract was awarded on  or between January 1, 2015 and	. Executive Order 13658  generally applies to the	 

**ORDER NO.: 247**  
**CONTRACT ID. NO.: CM224PMF123441B**

January 29, 2022, and the  contract is not renewed or  extended on or after January  30, 2022:         	contract.  . The contractor must pay all   covered workers at least   \$12.90 per hour (or the   applicable wage rate listed   on this wage determination,   if it is higher) for all   hours spent performing on   that contract in 2024. 
---	--

The applicable Executive Order minimum wage rate will be adjusted annually. If this contract is covered by one of the Executive Orders and a classification considered necessary for performance of work on the contract does not appear on this wage determination, the contractor must still submit a conformance request.

Additional information on contractor requirements and worker protections under the Executive Orders is available at <http://www.dol.gov/whd/govcontracts>.

Modification Number	Publication Date
0	01/05/2024

SUVA2016-010 07/02/2018

	Rates	Fringes
CARPENTER, Includes Form Work....	\$ 16.52 **	0.00
CEMENT MASON/CONCRETE FINISHER...	\$ 19.35	0.00
IRONWORKER, REINFORCING.....	\$ 20.80	0.00
LABORER: Asphalt, Includes Raker, Shoveler, Spreader and Distributor.....	\$ 15.90 **	0.00
LABORER: Common or General.....	\$ 13.96 **	0.00
LABORER: Pipelayer.....	\$ 16.75 **	0.00
OPERATOR: Backhoe/Excavator/Trackhoe.....	\$ 17.79	0.69

**ORDER NO.: 247**  
**CONTRACT ID. NO.: CM224PMF123441B**

OPERATOR: Broom/Sweeper.....	\$ 12.25 **	0.23
OPERATOR: Bulldozer.....	\$ 19.36	0.00
OPERATOR: Crane.....	\$ 26.68	0.00
OPERATOR: Grader/Blade, Includes Finishing.....	\$ 26.13	0.00
OPERATOR: Loader.....	\$ 19.36	0.00
OPERATOR: Mechanic.....	\$ 18.57	0.00
OPERATOR: Milling Machine.....	\$ 21.13	0.00
OPERATOR: PAVEMENT PLANER GROUNDSMEN.....	\$ 14.81 **	0.29
OPERATOR: PAVEMENT PLANER.....	\$ 17.28	0.00
OPERATOR: Paver (Asphalt, Aggregate, and Concrete).....	\$ 17.06 **	0.00
OPERATOR: Roller (Finishing)....	\$ 15.32 **	0.00
OPERATOR: Roller.....	\$ 15.85 **	0.00
OPERATOR: TRACTOR (UTILITY).....	\$ 12.25 **	0.23
OPERATOR: Asphalt Spreader and Distributor.....	\$ 15.95 **	0.00
PAVEMENT MARKING OPERATOR.....	\$ 19.40	0.00
PAVEMENT MARKING TRUCK DRIVER....	\$ 19.00	0.00
TRAFFIC CONTROL: Flagger.....	\$ 11.45 **	0.00
TRUCK DRIVER : HEAVY 7CY & UNDER.....	\$ 16.69 **	0.00
TRUCK DRIVER: 1/Single Axle Truck.....	\$ 15.52 **	0.00
TRUCK DRIVER: HEAVY OVER 7 CY.....	\$ 16.69 **	0.00

**ORDER NO.: 247**  
**CONTRACT ID. NO.: CM224PMF123441B**

TRUCK DRIVER: MULTI AXLE.....\$ 16.63 \*\* 0.00

---

WELDERS - Receive rate prescribed for craft performing operation to which welding is incidental.

=====  
\*\* Workers in this classification may be entitled to a higher minimum wage under Executive Order 14026 (\$17.20) or 13658 (\$12.90). Please see the Note at the top of the wage determination for more information. Please also note that the minimum wage requirements of Executive Order 14026 are not currently being enforced as to any contract or subcontract to which the states of Texas, Louisiana, or Mississippi, including their agencies, are a party.

Note: Executive Order (EO) 13706, Establishing Paid Sick Leave for Federal Contractors applies to all contracts subject to the Davis-Bacon Act for which the contract is awarded (and any solicitation was issued) on or after January 1, 2017. If this contract is covered by the EO, the contractor must provide employees with 1 hour of paid sick leave for every 30 hours they work, up to 56 hours of paid sick leave each year. Employees must be permitted to use paid sick leave for their own illness, injury or other health-related needs, including preventive care; to assist a family member (or person who is like family to the employee) who is ill, injured, or has other health-related needs, including preventive care; or for reasons resulting from, or to assist a family member (or person who is like family to the employee) who is a victim of, domestic violence, sexual assault, or stalking. Additional information on contractor requirements and worker protections under the EO is available at <https://www.dol.gov/agencies/whd/government-contracts>.

Unlisted classifications needed for work not included within the scope of the classifications listed may be added after award only as provided in the labor standards contract clauses (29CFR 5.5 (a) (1) (iii)).

---

**ORDER NO.: 247**  
**CONTRACT ID. NO.: CM224PMF123441B**

The body of each wage determination lists the classification and wage rates that have been found to be prevailing for the cited type(s) of construction in the area covered by the wage determination. The classifications are listed in alphabetical order of ""identifiers"" that indicate whether the particular rate is a union rate (current union negotiated rate for local), a survey rate (weighted average rate) or a union average rate (weighted union average rate).

Union Rate Identifiers

A four letter classification abbreviation identifier enclosed in dotted lines beginning with characters other than ""SU"" or ""UAVG"" denotes that the union classification and rate were prevailing for that classification in the survey. Example: PLUM0198-005 07/01/2014. PLUM is an abbreviation identifier of the union which prevailed in the survey for this classification, which in this example would be Plumbers. 0198 indicates the local union number or district council number where applicable, i.e., Plumbers Local 0198. The next number, 005 in the example, is an internal number used in processing the wage determination. 07/01/2014 is the effective date of the most current negotiated rate, which in this example is July 1, 2014.

Union prevailing wage rates are updated to reflect all rate changes in the collective bargaining agreement (CBA) governing this classification and rate.

Survey Rate Identifiers

Classifications listed under the ""SU"" identifier indicate that no one rate prevailed for this classification in the survey and the published rate is derived by computing a weighted average rate based on all the rates reported in the survey for that classification. As this weighted average rate includes all rates reported in the survey, it may include both union and non-union rates. Example: SULA2012-007 5/13/2014. SU indicates the rates are survey rates based on a weighted average calculation of rates and are not majority rates. LA indicates the State of Louisiana. 2012 is the year of survey on which these classifications and rates are based. The next number, 007 in the example, is an internal number used in producing the wage determination. 5/13/2014 indicates the survey completion date for the classifications and rates under that identifier.

**ORDER NO.: 247**  
**CONTRACT ID. NO.: CM224PMF123441B**

Survey wage rates are not updated and remain in effect until a new survey is conducted.

Union Average Rate Identifiers

Classification(s) listed under the UAVG identifier indicate that no single majority rate prevailed for those classifications; however, 100% of the data reported for the classifications was union data. EXAMPLE: UAVG-OH-0010 08/29/2014. UAVG indicates that the rate is a weighted union average rate. OH indicates the state. The next number, 0010 in the example, is an internal number used in producing the wage determination. 08/29/2014 indicates the survey completion date for the classifications and rates under that identifier.

A UAVG rate will be updated once a year, usually in January of each year, to reflect a weighted average of the current negotiated/CBA rate of the union locals from which the rate is based.

**ORDER NO.: 247**  
**CONTRACT ID. NO.: CM224PMF123441B**

"General Decision Number: VA20240085 01/05/2024

Superseded General Decision Number: VA20230085

State: Virginia

Construction Type: Highway

County: Patrick County in Virginia.

HIGHWAY CONSTRUCTION PROJECTS (excluding tunnels, building structures in rest area projects & railroad construction; bascule, suspension & spandrel arch bridges designed for commercial navigation, bridges involving marine construction; and other major bridges).

Note: Contracts subject to the Davis-Bacon Act are generally required to pay at least the applicable minimum wage rate required under Executive Order 14026 or Executive Order 13658. Please note that these Executive Orders apply to covered contracts entered into by the federal government that are subject to the Davis-Bacon Act itself, but do not apply to contracts subject only to the Davis-Bacon Related Acts, including those set forth at 29 CFR 5.1(a)(1).

If the contract is entered into on or after January 30, 2022, or the contract is renewed or extended (e.g., an option is exercised) on or after January 30, 2022:	. Executive Order 14026 generally applies to the contract.	
	. The contractor must pay all covered workers at least \$17.20 per hour (or the applicable wage rate listed on this wage determination, if it is higher) for all hours spent performing on the contract in 2024.	
If the contract was awarded on or between January 1, 2015 and January 29, 2022, and the contract is not renewed or extended on or after January 30, 2022:	. Executive Order 13658 generally applies to the contract.	
	. The contractor must pay all covered workers at least \$12.90 per hour (or the applicable wage rate listed on this wage determination,	

**ORDER NO.: 247**  
**CONTRACT ID. NO.: CM224PMF123441B**

	if it is higher) for all
	hours spent performing on
	that contract in 2024.

The applicable Executive Order minimum wage rate will be adjusted annually. If this contract is covered by one of the Executive Orders and a classification considered necessary for performance of work on the contract does not appear on this wage determination, the contractor must still submit a conformance request.

Additional information on contractor requirements and worker protections under the Executive Orders is available at <http://www.dol.gov/whd/govcontracts>.

Modification Number	Publication Date
0	01/05/2024

SUVA2016-021 07/02/2018

	Rates	Fringes
CARPENTER, Includes Form Work.....	\$ 16.52 **	0.00
CEMENT MASON/CONCRETE FINISHER...	\$ 19.35	0.00
IRONWORKER, REINFORCING.....	\$ 20.80	0.00
LABORER: Asphalt, Includes Raker, Shoveler, Spreader and Distributor.....	\$ 15.90 **	0.00
LABORER: Common or General.....	\$ 15.11 **	0.00
LABORER: Pipelayer.....	\$ 16.75 **	0.00
OPERATOR: Backhoe/Excavator/Trackhoe.....	\$ 20.53	0.00
OPERATOR: Broom/Sweeper.....	\$ 12.25 **	0.23
OPERATOR: Bulldozer.....	\$ 19.36	0.00
OPERATOR: Crane.....	\$ 26.68	0.00



**ORDER NO.: 247**  
**CONTRACT ID. NO.: CM224PMF123441B**

OPERATOR: Grader/Blade, Includes Finishing.....	\$ 26.13	0.00
OPERATOR: Loader.....	\$ 19.36	0.00
OPERATOR: Mechanic.....	\$ 18.57	0.00
OPERATOR: Milling Machine.....	\$ 21.13	0.00
OPERATOR: PAVEMENT PLANER GROUNDSMEN.....	\$ 14.81 **	0.29
OPERATOR: PAVEMENT PLANER.....	\$ 17.28	0.00
OPERATOR: Paver (Asphalt, Aggregate, and Concrete).....	\$ 16.80 **	0.00
OPERATOR: Roller (Finishing)....	\$ 15.17 **	0.00
OPERATOR: Roller.....	\$ 15.85 **	0.00
OPERATOR: TRACTOR (UTILITY).....	\$ 12.25 **	0.23
OPERATOR: Asphalt Spreader and Distributor.....	\$ 15.95 **	0.00
PAVEMENT MARKING OPERATOR.....	\$ 19.40	0.00
PAVEMENT MARKING TRUCK DRIVER....	\$ 19.00	0.00
TRAFFIC CONTROL: Flagger.....	\$ 11.45 **	0.00
TRUCK DRIVER : HEAVY 7CY & UNDER.....	\$ 16.69 **	0.00
TRUCK DRIVER: 1/Single Axle Truck.....	\$ 15.80 **	0.00
TRUCK DRIVER: HEAVY OVER 7 CY.....	\$ 16.69 **	0.00
TRUCK DRIVER: MULTI AXLE.....	\$ 17.58	0.77

-----  
WELDERS - Receive rate prescribed for craft performing  
operation to which welding is incidental.

**ORDER NO.: 247**  
**CONTRACT ID. NO.: CM224PMF123441B**

=====  
\*\* Workers in this classification may be entitled to a higher minimum wage under Executive Order 14026 (\$17.20) or 13658 (\$12.90). Please see the Note at the top of the wage determination for more information. Please also note that the minimum wage requirements of Executive Order 14026 are not currently being enforced as to any contract or subcontract to which the states of Texas, Louisiana, or Mississippi, including their agencies, are a party.

Note: Executive Order (EO) 13706, Establishing Paid Sick Leave for Federal Contractors applies to all contracts subject to the Davis-Bacon Act for which the contract is awarded (and any solicitation was issued) on or after January 1, 2017. If this contract is covered by the EO, the contractor must provide employees with 1 hour of paid sick leave for every 30 hours they work, up to 56 hours of paid sick leave each year. Employees must be permitted to use paid sick leave for their own illness, injury or other health-related needs, including preventive care; to assist a family member (or person who is like family to the employee) who is ill, injured, or has other health-related needs, including preventive care; or for reasons resulting from, or to assist a family member (or person who is like family to the employee) who is a victim of, domestic violence, sexual assault, or stalking. Additional information on contractor requirements and worker protections under the EO is available at <https://www.dol.gov/agencies/whd/government-contracts>.

Unlisted classifications needed for work not included within the scope of the classifications listed may be added after award only as provided in the labor standards contract clauses (29CFR 5.5 (a) (1) (iii)).

-----  
The body of each wage determination lists the classification and wage rates that have been found to be prevailing for the cited type(s) of construction in the area covered by the wage determination. The classifications are listed in alphabetical order of ""identifiers"" that indicate whether the particular rate is a union rate (current union negotiated rate for local), a survey rate (weighted average rate) or a union average rate (weighted union average rate).

**ORDER NO.: 247**  
**CONTRACT ID. NO.: CM224PMF123441B**

Union Rate Identifiers

A four letter classification abbreviation identifier enclosed in dotted lines beginning with characters other than ""SU"" or ""UAVG"" denotes that the union classification and rate were prevailing for that classification in the survey. Example: PLUM0198-005 07/01/2014. PLUM is an abbreviation identifier of the union which prevailed in the survey for this classification, which in this example would be Plumbers. 0198 indicates the local union number or district council number where applicable, i.e., Plumbers Local 0198. The next number, 005 in the example, is an internal number used in processing the wage determination. 07/01/2014 is the effective date of the most current negotiated rate, which in this example is July 1, 2014.

Union prevailing wage rates are updated to reflect all rate changes in the collective bargaining agreement (CBA) governing this classification and rate.

Survey Rate Identifiers

Classifications listed under the ""SU"" identifier indicate that no one rate prevailed for this classification in the survey and the published rate is derived by computing a weighted average rate based on all the rates reported in the survey for that classification. As this weighted average rate includes all rates reported in the survey, it may include both union and non-union rates. Example: SULA2012-007 5/13/2014. SU indicates the rates are survey rates based on a weighted average calculation of rates and are not majority rates. LA indicates the State of Louisiana. 2012 is the year of survey on which these classifications and rates are based. The next number, 007 in the example, is an internal number used in producing the wage determination. 5/13/2014 indicates the survey completion date for the classifications and rates under that identifier.

Survey wage rates are not updated and remain in effect until a new survey is conducted.

Union Average Rate Identifiers

Classification(s) listed under the UAVG identifier indicate that no single majority rate prevailed for those classifications; however, 100% of the data reported for the classifications was union data. EXAMPLE: UAVG-OH-0010

**ORDER NO.: 247**  
**CONTRACT ID. NO.: CM224PMF123441B**

08/29/2014. UAVG indicates that the rate is a weighted union average rate. OH indicates the state. The next number, 0010 in the example, is an internal number used in producing the wage determination. 08/29/2014 indicates the survey completion date for the classifications and rates under that identifier.

A UAVG rate will be updated once a year, usually in January of each year, to reflect a weighted average of the current negotiated/CBA rate of the union locals from which the rate is based.

**ORDER NO.: 247**  
**CONTRACT ID. NO.: CM224PMF123441B**

U.S. DEPARTMENT OF LABOR  
OFFICE OF THE SECRETARY  
WASHINGTON  
**DECISION OF THE SECRETARY**

This case is before the Department of Labor pursuant to a request for a wage predetermination as required by law applicable to the work described.

A study has been made of wage conditions in the locality and based on information available to the Department of Labor the wage rates and fringe payments listed are hereby determined by the Secretary of Labor as prevailing for the described classes for labor in accordance with applicable law.

This wage determination decision and any modifications thereof during the period prior to the stated expiration date shall be made a part of every contract for performance of the described work as provided by applicable law and regulations of the Secretary of Labor, and the wage rates and fringe payments contained in this decision, including modifications, shall be the minimums to be paid under any such contract and subcontractors on the work.

The Contracting Officer shall require that any class of laborers and mechanics which is not listed in the wage determination and which is to be employed under the Contract, shall be classified or reclassified conformably to the wage determination, and a report of the action taken shall be sent by the Federal agency to the Secretary of Labor. In the event the interested parties cannot agree on the proper classification or reclassification of a particular class of laborers and mechanics to be used, the question accompanied by the recommendation of the Contracting Officer shall be referred to the Secretary for determination.

Before using apprentices on the job the contractor shall present to the Contracting Officer written evidence of registration of such employees in a program of a State apprenticeship and training agency approved and recognized by the U.S. Bureau of Apprenticeship and Training. In the absence of such a State agency, the Contractor shall submit evidence of approval and registration by the U.S. Bureau of Apprenticeship and Training.

The Contractor shall submit to the Contracting Officer written evidence of the established apprentice-journeyman ratios and wage in the project area, which will be the basis for establishing such ratios and rates for the project under the applicable contract provisions.

Fringe payments include medical and hospital care, compensation for injuries or illness resulting from occupational activity, unemployment benefits, life insurance, disability and sickness insurance, accident insurance (all designated as health and welfare), pensions, vacation and holiday pay, apprenticeship or other similar programs and other bona fide fringe benefits.

By direction of the Secretary of Labor



E. Irving Manger, Associate Administrator  
Division of Wage Determinations  
Wage and Labor Standards Administration

**ORDER NO.: 247**  
**CONTRACT ID. NO.: CM224PMF123441B**

[SP0F0-000130-02](#)

October 3, 2023  
FHWA-1273 (Electronic Version)

The following Form **FHWA-1273** titled **REQUIRED CONTRACT PROVISIONS, FEDERAL-AID CONSTRUCTION CONTRACTS** shall apply to this contract:

=====

FHWA-1273 – Revised October 23, 2023

**REQUIRED CONTRACT PROVISIONS**  
**FEDERAL-AID CONSTRUCTION CONTRACTS**

- I. General
- II. Nondiscrimination
- III. Non-segregated Facilities
- IV. Davis-Bacon and Related Act Provisions
- V. Contract Work Hours and Safety Standards Act Provisions
- VI. Subletting or Assigning the Contract
- VII. Safety: Accident Prevention
- VIII. False Statements Concerning Highway Projects
- IX. Implementation of Clean Air Act and Federal Water Pollution Control Act
- X. Certification Regarding Debarment, Suspension, Ineligibility and Voluntary Exclusion
- XI. Certification Regarding Use of Contract Funds for Lobbying
- XII. Use of United States-Flag Vessels:

ATTACHMENTS

A. Employment and Materials Preference for Appalachian Development Highway System or Appalachian Local Access Road Contracts (included in Appalachian contracts only)

**I. GENERAL**

1. Form FHWA-1273 must be physically incorporated in each construction contract funded under title 23, United States Code, as required in 23 CFR 633.102(b) (excluding emergency contracts solely intended for debris removal). The contractor (or subcontractor) must insert this form in each subcontract and further require its inclusion in all lower tier subcontracts (excluding purchase orders, rental agreements and other agreements for supplies or services). 23 CFR 633.102(e).

The applicable requirements of Form FHWA-1273 are incorporated by reference for work done under any purchase order, rental agreement or agreement for other services. The prime contractor shall be responsible for compliance by any subcontractor, lower-tier subcontractor or service provider. 23 CFR 633.102(e).

Form FHWA-1273 must be included in all Federal-aid design- build contracts, in all subcontracts and in lower tier subcontracts (excluding subcontracts for design services, purchase orders, rental agreements

**ORDER NO.: 247**  
**CONTRACT ID. NO.: CM224PMF123441B**

and other agreements for supplies or services) in accordance with 23 CFR 633.102. The design-builder shall be responsible for compliance by any subcontractor, lower-tier subcontractor or service provider.

Contracting agencies may reference Form FHWA-1273 in solicitation-for-bids or request-for-proposals documents, however, the Form FHWA-1273 must be physically incorporated (not referenced) in all contracts, subcontracts and lower-tier subcontracts (excluding purchase orders, rental agreements and other agreements for supplies or services related to a construction contract). 23 CFR 633.102(b).

2. Subject to the applicability criteria noted in the following sections, these contract provisions shall apply to all work performed on the contract by the contractor's own organization and with the assistance of workers under the contractor's immediate superintendence and to all work performed on the contract by piecework, station work, or by subcontract. 23 CFR 633.102(d).

3. A breach of any of the stipulations contained in these Required Contract Provisions may be sufficient grounds for withholding of progress payments, withholding of final payment, termination of the contract, suspension / debarment or any other action determined to be appropriate by the contracting agency and FHWA.

4. Selection of Labor: During the performance of this contract, the contractor shall not use convict labor for any purpose within the limits of a construction project on a Federal-aid highway unless it is labor performed by convicts who are on parole, supervised release, or probation. 23 U.S.C. 114(b). The term Federal-aid highway does not include roadways functionally classified as local roads or rural minor collectors. 23 U.S.C. 101(a).

**ii. NONDISCRIMINATION** (23 CFR 230.107(a); 23 CFR Part 230, Subpart A, Appendix A; EO 11246)

The provisions of this section related to 23 CFR Part 230, Subpart A, Appendix A are applicable to all Federal-aid construction contracts and to all related construction subcontracts of \$10,000 or more. The provisions of 23 CFR Part 230 are not applicable to material supply, engineering, or architectural service contracts.

In addition, the contractor and all subcontractors must comply with the following policies: Executive Order 11246, 41 CFR Part 60, 29 CFR Parts 1625-1627, 23 U.S.C. 140, Section 504

of the Rehabilitation Act of 1973, as amended (29 U.S.C. 794), Title VI of the Civil Rights Act of 1964, as amended (42 U.S.C. 2000d et seq.), and related regulations including 49 CFR Parts 21, 26, and 27; and 23 CFR Parts 200, 230, and 633.

The contractor and all subcontractors must comply with: the requirements of the Equal Opportunity Clause in 41 CFR 60- 1.4(b) and, for all construction contracts exceeding \$10,000, the Standard Federal Equal Employment Opportunity Construction Contract Specifications in 41 CFR 60-4.3.

Note: The U.S. Department of Labor has exclusive authority to determine compliance with Executive Order 11246 and the policies of the Secretary of Labor including 41 CFR Part 60, and 29 CFR Parts 1625-1627. The contracting agency and the FHWA have the authority and the responsibility to ensure compliance with 23 U.S.C. 140, Section 504 of the Rehabilitation Act of 1973, as amended (29 U.S.C.

**ORDER NO.: 247**  
**CONTRACT ID. NO.: CM224PMF123441B**

794), and Title VI of the Civil Rights Act of 1964, as amended (42 U.S.C. 2000d et seq.), and related regulations including 49 CFR Parts 21, 26, and 27; and 23 CFR Parts 200, 230, and 633.

The following provision is adopted from 23 CFR Part 230, Subpart A, Appendix A, with appropriate revisions to conform to the U.S. Department of Labor (US DOL) and FHWA requirements.

**1. Equal Employment Opportunity:** Equal Employment Opportunity (EEO) requirements not to discriminate and to take affirmative action to assure equal opportunity as set forth under laws, executive orders, rules, regulations (see 28 CFR Part 35, 29 CFR Part 1630, 29 CFR Parts 1625-1627, 41 CFR Part 60 and 49 CFR Part 27) and orders of the Secretary of Labor as modified by the provisions prescribed herein, and imposed pursuant to 23 U.S.C. 140, shall constitute the EEO and specific affirmative action standards for the contractor's project activities under this contract. The provisions of the Americans with Disabilities Act of 1990 (42 U.S.C. 12101 et seq.) set forth under 28 CFR Part 35 and 29 CFR Part 1630 are incorporated by reference in this contract. In the execution of this contract, the contractor agrees to comply with the following minimum specific requirement activities of EEO:

a. The contractor will work with the contracting agency and the Federal Government to ensure that it has made every good faith effort to provide equal opportunity with respect to all of its terms and conditions of employment and in their review of activities under the contract. 23 CFR 230.409 (g)(4) & (5).

b. The contractor will accept as its operating policy the following statement:

"It is the policy of this Company to assure that applicants are employed, and that employees are treated during employment, without regard to their race, religion, sex, sexual orientation, gender identity, color, national origin, age or disability. Such action shall include: employment, upgrading, demotion, or transfer; recruitment or recruitment advertising; layoff or termination; rates of pay or other forms of compensation; and selection for training, including apprenticeship, pre-apprenticeship, and/or on-the-job training."

**2. EEO Officer:** The contractor will designate and make known to the contracting officers an EEO Officer who will have the responsibility for and must be capable of effectively administering and promoting an active EEO program and who must be assigned adequate authority and responsibility to do so.

**3. Dissemination of Policy:** All members of the contractor's staff who are authorized to hire, supervise, promote, and discharge employees, or who recommend such action or are substantially involved in such action, will be made fully cognizant of and will implement the contractor's EEO policy and contractual responsibilities to provide EEO in each grade and classification of employment. To ensure that the above agreement will be met, the following actions will be taken as a minimum:

a. Periodic meetings of supervisory and personnel office employees will be conducted before the start of work and then not less often than once every six months, at which time the contractor's EEO policy and its implementation will be reviewed and explained. The meetings will be conducted by the EEO Officer or other knowledgeable company official.

b. All new supervisory or personnel office employees will be given a thorough indoctrination by the EEO Officer, covering all major aspects of the contractor's EEO obligations within thirty days following



**ORDER NO.: 247**  
**CONTRACT ID. NO.: CM224PMF123441B**

their reporting for duty with the contractor.

c. All personnel who are engaged in direct recruitment for the project will be instructed by the EEO Officer in the contractor's procedures for locating and hiring minorities and women.

d. Notices and posters setting forth the contractor's EEO policy will be placed in areas readily accessible to employees, applicants for employment and potential employees.

e. The contractor's EEO policy and the procedures to implement such policy will be brought to the attention of employees by means of meetings, employee handbooks, or other appropriate means.

**4. Recruitment:** When advertising for employees, the contractor will include in all advertisements for employees the notation: "An Equal Opportunity Employer." All such advertisements will be placed in publications having a large circulation among minorities and women in the area from which the project work force would normally be derived.

a. The contractor will, unless precluded by a valid bargaining agreement, conduct systematic and direct recruitment through public and private employee referral sources likely to yield qualified minorities and women. To meet this requirement, the contractor will identify sources of potential minority group employees and establish with such identified sources procedures whereby minority and women applicants may be referred to the contractor for employment consideration.

b. In the event the contractor has a valid bargaining agreement providing for exclusive hiring hall referrals, the contractor is expected to observe the provisions of that agreement to the extent that the system meets the contractor's compliance with EEO contract provisions. Where implementation of such an agreement has the effect of discriminating against minorities or women, or obligates the contractor to do the same, such implementation violates Federal nondiscrimination provisions.

c. The contractor will encourage its present employees to refer minorities and women as applicants for employment. Information and procedures with regard to referring such applicants will be discussed with employees.

**5. Personnel Actions:** Wages, working conditions, and employee benefits shall be established and administered, and personnel actions of every type, including hiring, upgrading, promotion, transfer, demotion, layoff, and termination, shall be taken without regard to race, color, religion, sex, sexual orientation, gender identity, national origin, age or disability. The following procedures shall be followed:

a. The contractor will conduct periodic inspections of project sites to ensure that working conditions and employee facilities do not indicate discriminatory treatment of project site personnel.

b. The contractor will periodically evaluate the spread of wages paid within each classification to determine any evidence of discriminatory wage practices.

c. The contractor will periodically review selected personnel actions in depth to determine whether there is evidence of discrimination. Where evidence is found, the contractor will promptly take corrective action. If the review indicates that the discrimination may extend beyond the actions reviewed, such corrective action shall include all affected persons.

d. The contractor will promptly investigate all complaints of alleged discrimination made to the

**ORDER NO.: 247**  
**CONTRACT ID. NO.: CM224PMF123441B**

contractor in connection with its obligations under this contract, will attempt to resolve such complaints, and will take appropriate corrective action within a reasonable time. If the investigation indicates that the discrimination may affect persons other than the complainant, such corrective action shall include such other persons. Upon completion of each investigation, the contractor will inform every complainant of all of their avenues of appeal.

**6. Training and Promotion:**

a. The contractor will assist in locating, qualifying, and increasing the skills of minorities and women who are applicants for employment or current employees. Such efforts should be aimed at developing full journey level status employees in the type of trade or job classification involved.

b. Consistent with the contractor's work force requirements and as permissible under Federal and State regulations, the contractor shall make full use of training programs (i.e., apprenticeship and on-the-job training programs for the geographical area of contract performance). In the event a special provision for training is provided under this contract, this subparagraph will be superseded as indicated in the special provision. The contracting agency may reserve training positions for persons who receive welfare assistance in accordance with 23 U.S.C. 140(a).

c. The contractor will advise employees and applicants for employment of available training programs and entrance requirements for each.

d. The contractor will periodically review the training and promotion potential of employees who are minorities and women and will encourage eligible employees to apply for such training and promotion.

**7. Unions:** If the contractor relies in whole or in part upon unions as a source of employees, the contractor will use good faith efforts to obtain the cooperation of such unions to increase opportunities for minorities and women. 23 CFR 230.409. Actions by the contractor, either directly or through a contractor's association acting as agent, will include the procedures set forth below:

a. The contractor will use good faith efforts to develop, in cooperation with the unions, joint training programs aimed toward qualifying more minorities and women for membership in the unions and increasing the skills of minorities and women so that they may qualify for higher paying employment.

b. The contractor will use good faith efforts to incorporate an EEO clause into each union agreement to the end that such union will be contractually bound to refer applicants without regard to their race, color, religion, sex, sexual orientation, gender identity, national origin, age, or disability.

c. The contractor is to obtain information as to the referral practices and policies of the labor union except that to the extent such information is within the exclusive possession of the labor union and such labor union refuses to furnish such information to the contractor, the contractor shall so certify to the contracting agency and shall set forth what efforts have been made to obtain such information.

d. In the event the union is unable to provide the contractor with a reasonable flow of referrals within the time limit set forth in the collective bargaining agreement, the contractor will, through independent recruitment efforts, fill the employment vacancies without regard to race, color, religion, sex, sexual orientation, gender identity, national origin, age, or disability; making full efforts to obtain qualified and/or qualifiable minorities and women. The failure of a union to provide sufficient referrals (even though it is obligated to provide exclusive referrals under the terms of a collective bargaining

**ORDER NO.: 247**  
**CONTRACT ID. NO.: CM224PMF123441B**

agreement) does not relieve the contractor from the requirements of this paragraph. In the event the union referral practice prevents the contractor from meeting the obligations pursuant to Executive Order 11246, as amended, and these special provisions, such contractor shall immediately notify the contracting agency.

**8. Reasonable Accommodation for Applicants / Employees with Disabilities:** The contractor must be familiar with the requirements for and comply with the Americans with Disabilities Act and all rules and regulations established thereunder. Employers must provide reasonable accommodation in all employment activities unless to do so would cause an undue hardship.

**9. Selection of Subcontractors, Procurement of Materials and Leasing of Equipment:** The contractor shall not discriminate on the grounds of race, color, religion, sex, sexual orientation, gender identity, national origin, age, or disability in the selection and retention of subcontractors, including procurement of materials and leases of equipment. The contractor shall take all necessary and reasonable steps to ensure nondiscrimination in the administration of this contract.

a. The contractor shall notify all potential subcontractors, suppliers, and lessors of their EEO obligations under this contract.

b. The contractor will use good faith efforts to ensure subcontractor compliance with their EEO obligations.

**10. Assurances Required:**

a. The requirements of 49 CFR Part 26 and the State DOT's FHWA-approved Disadvantaged Business Enterprise (DBE) program are incorporated by reference.

b. The contractor, subrecipient or subcontractor shall not discriminate on the basis of race, color, national origin, or sex in the performance of this contract. The contractor shall carry out applicable requirements of 49 CFR part 26 in the award and administration of DOT-assisted contracts. Failure by the contractor to carry out these requirements is a material breach of this contract, which may result in the termination of this contract or such other remedy as the recipient deems appropriate, which may include, but is not limited to:

- (1) Withholding monthly progress payments;
- (2) Assessing sanctions;
- (3) Liquidated damages; and/or
- (4) Disqualifying the contractor from future bidding as non-responsible.

c. The Title VI and nondiscrimination provisions of U.S. DOT Order 1050.2A at Appendixes A and E are incorporated by reference. 49 CFR Part 21.

**11. Records and Reports:** The contractor shall keep such records as necessary to document compliance with the EEO requirements. Such records shall be retained for a period of three years following the date of the final payment to the contractor for all contract work and shall be available at reasonable times and places for inspection by authorized representatives of the contracting agency and the FHWA.

a. The records kept by the contractor shall document the following:

(1) The number and work hours of minority and non-minority group members and women employed in each work classification on the project;

**ORDER NO.: 247**  
**CONTRACT ID. NO.: CM224PMF123441B**

(2) The progress and efforts being made in cooperation with unions, when applicable, to increase employment opportunities for minorities and women; and

(3) The progress and efforts being made in locating, hiring, training, qualifying, and upgrading minorities and women.

b. The contractors and subcontractors will submit an annual report to the contracting agency each July for the duration of the project indicating the number of minority, women, and non- minority group employees currently engaged in each work classification required by the contract work. This information is to be reported on [Form FHWA-1391](#). The staffing data should represent the project work force on board in all or any part of the last payroll period preceding the end of July. If on-the-job training is being required by special provision, the contractor will be required to collect and report training data. The employment data should reflect the work force on board during all or any part of the last payroll period preceding the end of July.

### **III. NONSEGREGATED FACILITIES**

This provision is applicable to all Federal-aid construction contracts and to all related construction subcontracts of more than \$10,000. 41 CFR 60-1.5.

As prescribed by 41 CFR 60-1.8, the contractor must ensure that facilities provided for employees are provided in such a manner that segregation on the basis of race, color, religion, sex, sexual orientation, gender identity, or national origin cannot result. The contractor may neither require such segregated use by written or oral policies nor tolerate such use by employee custom. The contractor's obligation extends further to ensure that its employees are not assigned to perform their services at any location under the contractor's control where the facilities are segregated. The term "facilities" includes waiting rooms, work areas, restaurants and other eating areas, time clocks, restrooms, washrooms, locker rooms and other storage or dressing areas, parking lots, drinking fountains, recreation or entertainment areas, transportation, and housing provided for employees. The contractor shall provide separate or single-user restrooms and necessary dressing or sleeping areas to assure privacy between sexes.

### **IV. DAVIS-BACON AND RELATED ACT PROVISIONS**

This section is applicable to all Federal-aid construction projects exceeding \$2,000 and to all related subcontracts and lower-tier subcontracts (regardless of subcontract size), in accordance with 29 CFR 5.5. The requirements apply to all projects located within the right-of-way of a roadway that is functionally classified as Federal-aid highway. 23 U.S.C. 113. This excludes roadways functionally classified as local roads or rural minor collectors, which are exempt. 23 U.S.C. 101. Where applicable law requires that projects be treated as a project on a Federal-aid highway, the provisions of this subpart will apply regardless of the location of the project. Examples include: Surface Transportation Block Grant Program projects funded under 23 U.S.C. 133 [excluding recreational trails projects], the Nationally Significant Freight and Highway Projects funded under 23 U.S.C. 117, and National Highway Freight Program projects funded under 23 U.S.C. 167.

The following provisions are from the U.S. Department of Labor regulations in 29 CFR 5.5 "Contract provisions and related matters" with minor revisions to conform to the FHWA- 1273 format and FHWA program requirements.

**ORDER NO.: 247**  
**CONTRACT ID. NO.: CM224PMF123441B**

**1. Minimum wages (29 CFR 5.5)**

a. *Wage rates and fringe benefits.* All laborers and mechanics employed or working upon the site of the work (or otherwise working in construction or development of the project under a development statute), will be paid unconditionally and not less often than once a week, and without subsequent deduction or rebate on any account (except such payroll deductions as are permitted by regulations issued by the Secretary of Labor under the Copeland Act ([29 CFR part 3](#))), the full amount of basic hourly wages and bona fide fringe benefits (or cash equivalents thereof) due at time of payment computed at rates not less than those contained in the wage determination of the Secretary of Labor which is attached hereto and made a part hereof, regardless of any contractual relationship which may be alleged to exist between the contractor and such laborers and mechanics. As provided in paragraphs (d) and (e) of 29 CFR 5.5, the appropriate wage determinations are effective by operation of law even if they have not been attached to the contract. Contributions made or costs reasonably anticipated for bona fide fringe benefits under the Davis-Bacon Act ([40U.S.C. 3141\(2\)\(B\)](#)) on behalf of laborers or mechanics are considered wages paid to such laborers or mechanics, subject to the provisions of paragraph 1.e. of this section; also, regular contributions made or costs incurred for more than a weekly period (but not less often than quarterly) under plans, funds, or programs which cover the particular weekly period, are deemed to be constructively made or incurred during such weekly period. Such laborers and mechanics must be paid the appropriate wage rate and fringe benefits on the wage determination for the classification(s) of work actually performed, without regard to skill, except as provided in paragraph 4. of this section. Laborers or mechanics performing work in more than one classification may be compensated at the rate specified for each classification for the time actually worked therein: *Provided*, That the employer's payroll records accurately set forth the time spent in each classification in which work is performed. The wage determination (including any additional classifications and wage rates conformed under paragraph 1.c. of this section) and the Davis-Bacon poster (WH-1321) must be posted at all times by the contractor and its subcontractors at the site of the work in a prominent and accessible place where it can be easily seen by the workers.

b. *Frequently recurring classifications.* (1) In addition to wage and fringe benefit rates that have been determined to be prevailing under the procedures set forth in [29 CFR part 1](#), a wage determination may contain, pursuant to § 1.3(f), wage and fringe benefit rates for classifications of laborers and mechanics for which conformance requests are regularly submitted pursuant to paragraph 1.c. of this section, provided that:

(i) The work performed by the classification is not performed by a classification in the wage determination for which a prevailing wage rate has been determined;

(ii) The classification is used in the area by the construction industry; and

(iii) The wage rate for the classification bears a reasonable relationship to the prevailing wage rates contained in the wage determination.

(2) The Administrator will establish wage rates for such classifications in accordance with paragraph 1.c.(1)(iii) of this section. Work performed in such a classification must be paid at no less than the wage and fringe benefit rate listed on the wage determination for such classification.

c. *Conformance.* (1) The contracting officer must require that any class of laborers or mechanics, including helpers, which is not listed in the wage determination and which is to be employed under the contract be classified in conformance with the wage determination. Conformance of an additional classification and wage rate and fringe benefits is appropriate only when the following criteria have been met:

**ORDER NO.: 247**  
**CONTRACT ID. NO.: CM224PMF123441B**

(i) The work to be performed by the classification requested is not performed by a classification in the wage determination; and

(ii) The classification is used in the area by the construction industry; and

(iii) The proposed wage rate, including any bona fide fringe benefits, bears a reasonable relationship to the wage rates contained in the wage determination.

(2) The conformance process may not be used to split, subdivide, or otherwise avoid application of classifications listed in the wage determination.

(3) If the contractor and the laborers and mechanics to be employed in the classification (if known), or their representatives, and the contracting officer agree on the classification and wage rate (including the amount designated for fringe benefits where appropriate), a report of the action taken will be sent by the contracting officer by email to [DBAconformance@dol.gov](mailto:DBAconformance@dol.gov). The Administrator, or an authorized representative, will approve, modify, or disapprove every additional classification action within 30 days of receipt and so advise the contracting officer or will notify the contracting officer within the 30-day period that additional time is necessary.

(4) In the event the contractor, the laborers or mechanics to be employed in the classification or their representatives, and the contracting officer do not agree on the proposed classification and wage rate (including the amount designated for fringe benefits, where appropriate), the contracting officer will, by email to [DBAconformance@dol.gov](mailto:DBAconformance@dol.gov), refer the questions, including the views of all interested parties and the recommendation of the contracting officer, to the Administrator for determination. The Administrator, or an authorized representative, will issue a determination within 30 days of receipt and so advise the contracting officer or will notify the contracting officer within the 30-day period that additional time is necessary.

(5) The contracting officer must promptly notify the contractor of the action taken by the Wage and Hour Division under paragraphs 1.c.(3) and (4) of this section. The contractor must furnish a written copy of such determination to each affected worker or it must be posted as a part of the wage determination. The wage rate (including fringe benefits where appropriate) determined pursuant to paragraph 1.c.(3) or (4) of this section must be paid to all workers performing work in the classification under this contract from the first day on which work is performed in the classification.

d. *Fringe benefits not expressed as an hourly rate.* Whenever the minimum wage rate prescribed in the contract for a class of laborers or mechanics includes a fringe benefit which is not expressed as an hourly rate, the contractor may either pay the benefit as stated in the wage determination or may pay another bona fide fringe benefit or an hourly cash equivalent thereof.

e. *Unfunded plans.* If the contractor does not make payments to a trustee or other third person, the contractor may consider as part of the wages of any laborer or mechanic the amount of any costs reasonably anticipated in providing bona fide fringe benefits under a plan or program, *Provided*, That the Secretary of Labor has found, upon the written request of the contractor, in accordance with the criteria set forth in § 5.28, that the applicable standards of the Davis-Bacon Act have been met. The Secretary of Labor may require the contractor to set aside in a separate account assets for the meeting of obligations under the plan or program.

f. *Interest.* In the event of a failure to pay all or part of the wages required by the contract, the

**ORDER NO.: 247**  
**CONTRACT ID. NO.: CM224PMF123441B**

contractor will be required to pay interest on any underpayment of wages.

**2. Withholding (29 CFR 5.5)**

a. *Withholding requirements.* The contracting agency may, upon its own action, or must, upon written request of an authorized representative of the Department of Labor, withhold or cause to be withheld from the contractor so much of the accrued payments or advances as may be considered necessary to satisfy the liabilities of the prime contractor or any subcontractor for the full amount of wages and monetary relief, including interest, required by the clauses set forth in this section for violations of this contract, or to satisfy any such liabilities required by any other Federal contract, or federally assisted contract subject to Davis-Bacon labor standards, that is held by the same prime contractor (as defined in § 5.2). The necessary funds may be withheld from the contractor under this contract, any other Federal contract with the same prime contractor, or any other federally assisted contract that is subject to Davis-Bacon labor standards requirements and is held by the same prime contractor, regardless of whether the other contract was awarded or assisted by the same agency, and such funds may be used to satisfy the contractor liability for which the funds were withheld. In the event of a contractor's failure to pay any laborer or mechanic, including any apprentice or helper working on the site of the work all or part of the wages required by the contract, or upon the contractor's failure to submit the required records as discussed in paragraph 3.d. of this section, the contracting agency may on its own initiative and after written notice to the contractor, take such action as may be necessary to cause the suspension of any further payment, advance, or guarantee of funds until such violations have ceased.

b. *Priority to withheld funds.* The Department has priority to funds withheld or to be withheld in accordance with paragraph

2.a. of this section or Section V, paragraph 3.a., or both, over claims to those funds by:

(1) A contractor's surety(ies), including without limitation performance bond sureties and payment bond sureties;

(2) A contracting agency for its procurement costs;

(3) A trustee(s) (either a court-appointed trustee or a U.S. trustee, or both) in bankruptcy of a contractor, or a contractor's bankruptcy estate;

(4) A contractor's assignee(s);

(5) A contractor's successor(s); or

(6) A claim asserted under the Prompt Payment Act, [31U.S.C. 3901–3907](#).

**3. Records and certified payrolls (29 CFR 5.5)**

a. *Basic record requirements (1) Length of record retention.* All regular payrolls and other basic records must be maintained by the contractor and any subcontractor during the course of the work and preserved for all laborers and mechanics working at the site of the work (or otherwise working in construction or development of the project under a development statute) for a period of at least 3 years after all the work on the prime contract is completed.

(2) *Information required.* Such records must contain the name; Social Security number; last known

**ORDER NO.: 247**  
**CONTRACT ID. NO.: CM224PMF123441B**

address, telephone number, and email address of each such worker; each worker's correct classification(s) of work actually performed; hourly rates of wages paid (including rates of contributions or costs anticipated for bona fide fringe benefits or cash equivalents thereof of the types described in [40 U.S.C. 3141\(2\)\(B\)](#) of the Davis-Bacon Act); daily and weekly number of hours actually worked in total and on each covered contract; deductions made; and actual wages paid.

(3) *Additional records relating to fringe benefits.* Whenever the Secretary of Labor has found under paragraph 1.e. of this section that the wages of any laborer or mechanic include the amount of any costs reasonably anticipated in providing benefits under a plan or program described in [40 U.S.C. 3141\(2\)\(B\)](#) of the Davis-Bacon Act, the contractor must maintain records which show that the commitment to provide such benefits is enforceable, that the plan or program is financially responsible, and that the plan or program has been communicated in writing to the laborers or mechanics affected, and records which show the costs anticipated or the actual cost incurred in providing such benefits.

(4) *Additional records relating to apprenticeship.* Contractors with apprentices working under approved programs must maintain written evidence of the registration of apprenticeship programs, the registration of the apprentices, and the ratios and wage rates prescribed in the applicable programs.

b. *Certified payroll requirements (1) Frequency and method of submission.* The contractor or subcontractor must submit weekly, for each week in which any DBA- or Related Acts- covered work is performed, certified payrolls to the contracting agency. The prime contractor is responsible for the submission of all certified payrolls by all subcontractors. A contracting agency or prime contractor may permit or require contractors to submit certified payrolls through an electronic system, as long as the electronic system requires a legally valid electronic signature; the system allows the contractor, the contracting agency, and the Department of Labor to access the certified payrolls upon request for at least 3 years after the work on the prime contract has been completed; and the contracting agency or prime contractor permits other methods of submission in situations where the contractor is unable or limited in its ability to use or access the electronic system.

(2) *Information required.* The certified payrolls submitted must set out accurately and completely all of the information required to be maintained under paragraph 3.a.(2) of this section, except that full Social Security numbers and last known addresses, telephone numbers, and email addresses must not be included on weekly transmittals. Instead, the certified payrolls need only include an individually identifying number for each worker ( e.g., the last four digits of the worker's Social Security number). The required weekly certified payroll information may be submitted using Optional Form WH-347 or in any other format desired. Optional Form WH-347 is available for this purpose from the Wage and Hour Division website at <https://www.dol.gov/sites/dolgov/files/WHD/legacy/files/wh347.pdf> or its successor website. It is not a violation of this section for a prime contractor to require a subcontractor to provide full Social Security numbers and last known addresses, telephone numbers, and email addresses to the prime contractor for its own records, without weekly submission by the subcontractor to the contracting agency.

(3) *Statement of Compliance.* Each certified payroll submitted must be accompanied by a "Statement of Compliance," signed by the contractor or subcontractor, or the contractor's or subcontractor's agent who pays or supervises the payment of the persons working on the contract, and must certify the following:

(i) That the certified payroll for the payroll period contains the information required to be provided under paragraph 3.b. of this section, the appropriate information and basic records are being maintained under paragraph 3.a. of this section, and such information and records are correct and complete;



**ORDER NO.: 247**  
**CONTRACT ID. NO.: CM224PMF123441B**

(ii) That each laborer or mechanic (including each helper and apprentice) working on the contract during the payroll period has been paid the full weekly wages earned, without rebate, either directly or indirectly, and that no deductions have been made either directly or indirectly from the full wages earned, other than permissible deductions as set forth in [29 CFR part 3](#); and

(iii) That each laborer or mechanic has been paid not less than the applicable wage rates and fringe benefits or cash equivalents for the classification(s) of work actually performed, as specified in the applicable wage determination incorporated into the contract.

(4) *Use of Optional Form WH-347.* The weekly submission of a properly executed certification set forth on the reverse side of Optional Form WH-347 will satisfy the requirement for submission of the "Statement of Compliance" required by paragraph 3.b.(3) of this section.

(5) *Signature.* The signature by the contractor, subcontractor, or the contractor's or subcontractor's agent must be an original handwritten signature or a legally valid electronic signature.

(6) *Falsification.* The falsification of any of the above certifications may subject the contractor or subcontractor to civil or criminal prosecution under [18 U.S.C. 1001](#) and [31 U.S.C. 3729](#).

(7) *Length of certified payroll retention.* The contractor or subcontractor must preserve all certified payrolls during the course of the work and for a period of 3 years after all the work on the prime contract is completed.

c. *Contracts, subcontracts, and related documents.* The contractor or subcontractor must maintain this contract or subcontract and related documents including, without limitation, bids, proposals, amendments, modifications, and extensions. The contractor or subcontractor must preserve these contracts, subcontracts, and related documents during the course of the work and for a period of 3 years after all the work on the prime contract is completed.

d. *Required disclosures and access* (1) *Required record disclosures and access to workers.* The contractor or subcontractor must make the records required under paragraphs 3.a. through 3.c. of this section, and any other documents that the contracting agency, the State DOT, the FHWA, or the Department of Labor deems necessary to determine compliance with the labor standards provisions of any of the applicable statutes referenced by § 5.1, available for inspection, copying, or transcription by authorized representatives of the contracting agency, the State DOT, the FHWA, or the Department of Labor, and must permit such representatives to interview workers during working hours on the job.

(2) *Sanctions for non-compliance with records and worker access requirements.* If the contractor or subcontractor fails to submit the required records or to make them available, or refuses to permit worker interviews during working hours on the job, the Federal agency may, after written notice to the contractor, sponsor, applicant, owner, or other entity, as the case may be, that maintains such records or that employs such workers, take such action as may be necessary to cause the suspension of any further payment, advance, or guarantee of funds. Furthermore, failure to submit the required records upon request or to make such records available, or to permit worker interviews during working hours on the job, may be grounds for debarment action pursuant to § 5.12. In addition, any contractor or other person that fails to submit the required records or make those records available to WHD within the time WHD requests that the records be produced will be precluded from introducing as evidence in an administrative proceeding under [29 CFR part 6](#) any of the required records that were not provided or made available to WHD. WHD will take into consideration a reasonable request from the contractor or person for an extension of the time for submission of records. WHD will determine the reasonableness of the request and may consider, among other things, the location of the records and the volume of

**ORDER NO.: 247**  
**CONTRACT ID. NO.: CM224PMF123441B**

production.

(3) *Required information disclosures.* Contractors and subcontractors must maintain the full Social Security number and last known address, telephone number, and email address of each covered worker, and must provide them upon request to the contracting agency, the State DOT, the FHWA, the contractor, or the Wage and Hour Division of the Department of Labor for purposes of an investigation or other compliance action.

**4. Apprentices and equal employment opportunity (29 CFR 5.5)**

a. *Apprentices (1) Rate of pay.* Apprentices will be permitted to work at less than the predetermined rate for the work they perform when they are employed pursuant to and individually registered in a bona fide apprenticeship program registered with the U.S. Department of Labor, Employment and Training Administration, Office of Apprenticeship (OA), or with a State Apprenticeship Agency recognized by the OA. A person who is not individually registered in the program, but who has been certified by the OA or a State Apprenticeship Agency (where appropriate) to be eligible for probationary employment as an apprentice, will be permitted to work at less than the predetermined rate for the work they perform in the first 90 days of probationary employment as an apprentice in such a program. In the event the OA or a State Apprenticeship Agency recognized by the OA withdraws approval of an apprenticeship program, the contractor will no longer be permitted to use apprentices at less than the applicable predetermined rate for the work performed until an acceptable program is approved.

(2) *Fringe benefits.* Apprentices must be paid fringe benefits in accordance with the provisions of the apprenticeship program. If the apprenticeship program does not specify fringe benefits, apprentices must be paid the full amount of fringe benefits listed on the wage determination for the applicable classification. If the Administrator determines that a different practice prevails for the applicable apprentice classification, fringe benefits must be paid in accordance with that determination.

(3) *Apprenticeship ratio.* The allowable ratio of apprentices to journeymen on the job site in any craft classification must not be greater than the ratio permitted to the contractor as to the entire work force under the registered program or the ratio applicable to the locality of the project pursuant to paragraph 4.a.(4) of this section. Any worker listed on a payroll at an apprentice wage rate, who is not registered or otherwise employed as stated in paragraph 4.a.(1) of this section, must be paid not less than the applicable wage rate on the wage determination for the classification of work actually performed. In addition, any apprentice performing work on the job site in excess of the ratio permitted under this section must be paid not less than the applicable wage rate on the wage determination for the work actually performed.

(4) *Reciprocity of ratios and wage rates.* Where a contractor is performing construction on a project in a locality other than the locality in which its program is registered, the ratios and wage rates (expressed in percentages of the journeyworker's hourly rate) applicable within the locality in which the construction is being performed must be observed. If there is no applicable ratio or wage rate for the locality of the project, the ratio and wage rate specified in the contractor's registered program must be observed.

b. *Equal employment opportunity.* The use of apprentices and journeymen under this part must be in conformity with the equal employment opportunity requirements of Executive Order 11246, as amended, and [29 CFR part 30](#).

c. Apprentices and Trainees (programs of the U.S. DOT).

**ORDER NO.: 247**  
**CONTRACT ID. NO.: CM224PMF123441B**

Apprentices and trainees working under apprenticeship and skill training programs which have been certified by the Secretary of Transportation as promoting EEO in connection with Federal-aid highway construction programs are not subject to the requirements of paragraph 4 of this Section IV. 23 CFR 230.111(e)(2). The straight time hourly wage rates for apprentices and trainees under such programs will be established by the particular programs. The ratio of apprentices and trainees to journeyworkers shall not be greater than permitted by the terms of the particular program.

**5. Compliance with Copeland Act requirements.** The contractor shall comply with the requirements of 29 CFR part 3, which are incorporated by reference in this contract as provided in 29 CFR 5.5.

**6. Subcontracts.** The contractor or subcontractor must insert FHWA-1273 in any subcontracts, along with the applicable wage determination(s) and such other clauses or contract modifications as the contracting agency may by appropriate instructions require, and a clause requiring the subcontractors to include these clauses and wage determination(s) in any lower tier subcontracts. The prime contractor is responsible for the compliance by any subcontractor or lower tier subcontractor with all the contract clauses in this section. In the event of any violations of these clauses, the prime contractor and any subcontractor(s) responsible will be liable for any unpaid wages and monetary relief, including interest from the date of the underpayment or loss, due to any workers of lower-tier subcontractors, and may be subject to debarment, as appropriate. 29 CFR 5.5.

**7. Contract termination: debarment.** A breach of the contract clauses in 29 CFR 5.5 may be grounds for termination of the contract, and for debarment as a contractor and a subcontractor as provided in 29 CFR 5.12.

**8. Compliance with Davis-Bacon and Related Act requirements.** All rulings and interpretations of the Davis- Bacon and Related Acts contained in 29 CFR parts 1, 3, and 5 are herein incorporated by reference in this contract as provided in 29 CFR 5.5.

**9. Disputes concerning labor standards.** As provided in 29 CFR 5.5, disputes arising out of the labor standards provisions of this contract shall not be subject to the general disputes clause of this contract. Such disputes shall be resolved in accordance with the procedures of the Department of Labor set forth in 29 CFR parts 5, 6, and 7. Disputes within the meaning of this clause include disputes between the contractor (or any of its subcontractors) and the contracting agency, the U.S. Department of Labor, or the employees or their representatives.

10. **Certification of eligibility.** a. By entering into this contract, the contractor certifies that neither it nor any person or firm who has an interest in the contractor's firm is a person or firm ineligible to be awarded Government contracts by virtue of [40U.S.C. 3144\(b\)](#) or § 5.12(a).

b. No part of this contract shall be subcontracted to any person or firm ineligible for award of a Government contract by virtue of [40 U.S.C. 3144\(b\)](#) or § 5.12(a).

c. The penalty for making false statements is prescribed in the U.S. Code, Title 18 Crimes and Criminal Procedure, [18U.S.C. 1001](#).

**11. Anti-retaliation.** It is unlawful for any person to discharge, demote, intimidate, threaten, restrain, coerce, blacklist, harass, or in any other manner discriminate against, or to cause any person to discharge, demote, intimidate, threaten, restrain, coerce, blacklist, harass, or in any other manner discriminate against, any worker or job applicant for:

**ORDER NO.: 247**  
**CONTRACT ID. NO.: CM224PMF123441B**

a. Notifying any contractor of any conduct which the worker reasonably believes constitutes a violation of the DBA, Related Acts, this part, or [29 CFR part 1](#) or [3](#);

b. Filing any complaint, initiating or causing to be initiated any proceeding, or otherwise asserting or seeking to assert on behalf of themselves or others any right or protection under the DBA, Related Acts, this part, or [29 CFR part 1](#) or [3](#);

c. Cooperating in any investigation or other compliance action, or testifying in any proceeding under the DBA, Related Acts, this part, or [29 CFR part 1](#) or [3](#); or

d. Informing any other person about their rights under the DBA, Related Acts, this part, or [29 CFR part 1](#) or [3](#).

**V. CONTRACT WORK HOURS AND SAFETY STANDARDS ACT**

Pursuant to 29 CFR 5.5(b), the following clauses apply to any Federal-aid construction contract in an amount in excess of \$100,000 and subject to the overtime provisions of the Contract Work Hours and Safety Standards Act. These clauses shall be inserted in addition to the clauses required by 29 CFR 5.5(a) or 29 CFR 4.6. As used in this paragraph, the terms laborers and mechanics include watchpersons and guards.

**1. Overtime requirements.** No contractor or subcontractor contracting for any part of the contract work which may require or involve the employment of laborers or mechanics shall require or permit any such laborer or mechanic in any workweek in which he or she is employed on such work to work in excess of forty hours in such workweek unless such laborer or mechanic receives compensation at a rate not less than one and one-half times the basic rate of pay for all hours worked in excess of forty hours in such workweek. 29 CFR 5.5.

**2. Violation; liability for unpaid wages; liquidated damages.** In the event of any violation of the clause set forth in paragraph 1. of this section the contractor and any subcontractor responsible therefor shall be liable for the unpaid wages and interest from the date of the underpayment. In addition, such contractor and subcontractor shall be liable to the United States (in the case of work done under contract for the District of Columbia or a territory, to such District or to such territory), for liquidated damages. Such liquidated damages shall be computed with respect to each individual laborer or mechanic, including watchpersons and guards, employed in violation of the clause set forth in paragraph 1. of this section, in the sum currently provided in 29 CFR 5.5(b)(2)\* for each calendar day on which such individual was required or permitted to work in excess of the standard workweek of forty hours without payment of the overtime wages required by the clause set forth in paragraph 1. of this section.

\* \$31 as of January 15, 2023 (See 88 FR 88 FR 2210) as may be adjusted annually by the Department of Labor, pursuant to the Federal Civil Penalties Inflation Adjustment Act of 1990.

**3. Withholding for unpaid wages and liquidated damages**

a. *Withholding process.* The FHWA or the contracting agency may, upon its own action, or must, upon written request of an authorized representative of the Department of Labor, withhold or cause to be withheld from the contractor so much of the accrued payments or advances as may be considered

**ORDER NO.: 247**  
**CONTRACT ID. NO.: CM224PMF123441B**

necessary to satisfy the liabilities of the prime contractor or any subcontractor for any unpaid wages; monetary relief, including interest; and liquidated damages required by the clauses set forth in this section on this contract, any other Federal contract with the same prime contractor, or any other federally assisted contract subject to the Contract Work Hours and Safety Standards Act that is held by the same prime contractor (as defined in § 5.2). The necessary funds may be withheld from the contractor under this contract, any other Federal contract with the same prime contractor, or any other federally assisted contract that is subject to the Contract Work Hours and Safety Standards Act and is held by the same prime contractor, regardless of whether the other contract was awarded or assisted by the same agency, and such funds may be used to satisfy the contractor liability for which the funds were withheld.

b. *Priority to withheld funds.* The Department has priority to funds withheld or to be withheld in accordance with Section IV paragraph 2.a. or paragraph 3.a. of this section, or both, over claims to those funds by:

(1) A contractor's surety(ies), including without limitation performance bond sureties and payment bond sureties;

(2) A contracting agency for its procurement costs;

(3) A trustee(s) (either a court-appointed trustee or a U.S. trustee, or both) in bankruptcy of a contractor, or a contractor's bankruptcy estate;

(4) A contractor's assignee(s);

(5) A contractor's successor(s); or

(6) A claim asserted under the Prompt Payment Act, [31U.S.C. 3901](#)–3907.

**4. Subcontracts.** The contractor or subcontractor must insert in any subcontracts the clauses set forth in paragraphs 1. through 5. of this section and a clause requiring the subcontractors to include these clauses in any lower tier subcontracts. The prime contractor is responsible for compliance by any subcontractor or lower tier subcontractor with the clauses set forth in paragraphs 1. through 5. In the event of any violations of these clauses, the prime contractor and any subcontractor(s) responsible will be liable for any unpaid wages and monetary relief, including interest from the date of the underpayment or loss, due to any workers of lower- tier subcontractors, and associated liquidated damages and may be subject to debarment, as appropriate.

**5. Anti-retaliation.** It is unlawful for any person to discharge, demote, intimidate, threaten, restrain, coerce, blacklist, harass, or in any other manner discriminate against, or to cause any person to discharge, demote, intimidate, threaten, restrain, coerce, blacklist, harass, or in any other manner discriminate against, any worker or job applicant for:

a. Notifying any contractor of any conduct which the worker reasonably believes constitutes a violation of the Contract Work Hours and Safety Standards Act (CWHSSA) or its implementing regulations in this part;

b. Filing any complaint, initiating or causing to be initiated any proceeding, or otherwise asserting or seeking to assert on behalf of themselves or others any right or protection under CWHSSA or this part;

**ORDER NO.: 247**  
**CONTRACT ID. NO.: CM224PMF123441B**

c. Cooperating in any investigation or other compliance action, or testifying in any proceeding under CWHSSA or this part; or

d. Informing any other person about their rights under CWHSSA or this part.

**VI. SUBLETTING OR ASSIGNING THE CONTRACT**

This provision is applicable to all Federal-aid construction contracts on the National Highway System pursuant to 23 CFR 635.116.

1. The contractor shall perform with its own organization contract work amounting to not less than 30 percent (or a greater percentage if specified elsewhere in the contract) of the total original contract price, excluding any specialty items designated by the contracting agency. Specialty items may be performed by subcontract and the amount of any such specialty items performed may be deducted from the total original contract price before computing the amount of work required to be performed by the contractor's own organization (23 CFR 635.116).

a. The term "perform work with its own organization" in paragraph 1 of Section VI refers to workers employed or leased by the prime contractor, and equipment owned or rented by the prime contractor, with or without operators. Such term does not include employees or equipment of a subcontractor or lower tier subcontractor, agents of the prime contractor, or any other assignees. The term may include payments for the costs of hiring leased employees from an employee leasing firm meeting all relevant Federal and State regulatory requirements. Leased employees may only be included in this term if the prime contractor meets all of the following conditions: (based on longstanding interpretation)

- (1) the prime contractor maintains control over the supervision of the day-to-day activities of the leased employees;
- (2) the prime contractor remains responsible for the quality of the work of the leased employees;
- (3) the prime contractor retains all power to accept or exclude individual employees from work on the project; and
- (4) the prime contractor remains ultimately responsible for the payment of predetermined minimum wages, the submission of payrolls, statements of compliance and all other Federal regulatory requirements.

b. "Specialty Items" shall be construed to be limited to work that requires highly specialized knowledge, abilities, or equipment not ordinarily available in the type of contracting organizations qualified and expected to bid or propose on the contract as a whole and in general are to be limited to minor components of the overall contract. 23 CFR 635.102.

2. Pursuant to 23 CFR 635.116(a), the contract amount upon which the requirements set forth in paragraph (1) of Section VI is computed includes the cost of material and manufactured products which are to be purchased or produced by the contractor under the contract provisions.

3. Pursuant to 23 CFR 635.116(c), the contractor shall furnish

(a) a competent superintendent or supervisor who is employed by the firm, has full authority to direct performance of the work in accordance with the contract requirements, and is in charge of all construction operations (regardless of who performs the work) and (b) such other of its own

**ORDER NO.: 247**  
**CONTRACT ID. NO.: CM224PMF123441B**

organizational resources (supervision, management, and engineering services) as the contracting officer determines is necessary to assure the performance of the contract.

4. No portion of the contract shall be sublet, assigned or otherwise disposed of except with the written consent of the contracting officer, or authorized representative, and such consent when given shall not be construed to relieve the contractor of any responsibility for the fulfillment of the contract. Written consent will be given only after the contracting agency has assured that each subcontract is evidenced in writing and that it contains all pertinent provisions and requirements of the prime contract. (based on long- standing interpretation of 23 CFR 635.116).
5. The 30-percent self-performance requirement of paragraph (1) is not applicable to design-build contracts; however, contracting agencies may establish their own self-performance requirements. 23 CFR 635.116(d).

**VII. SAFETY: ACCIDENT PREVENTION**

This provision is applicable to all Federal-aid construction contracts and to all related subcontracts.

1. In the performance of this contract the contractor shall comply with all applicable Federal, State, and local laws governing safety, health, and sanitation (23 CFR Part 635). The contractor shall provide all safeguards, safety devices and protective equipment and take any other needed actions as it determines, or as the contracting officer may determine, to be reasonably necessary to protect the life and health of employees on the job and the safety of the public and to protect property in connection with the performance of the work covered by the contract. 23 CFR 635.108.

2. It is a condition of this contract, and shall be made a condition of each subcontract, which the contractor enters into pursuant to this contract, that the contractor and any subcontractor shall not permit any employee, in performance of the contract, to work in surroundings or under conditions which are unsanitary, hazardous or dangerous to his/her health or safety, as determined under construction safety and health standards (29 CFR Part 1926) promulgated by the Secretary of Labor, in accordance with Section 107 of the Contract Work Hours and Safety Standards Act (40 U.S.C. 3704). 29 CFR 1926.10.

3. Pursuant to 29 CFR 1926.3, it is a condition of this contract that the Secretary of Labor or authorized representative thereof, shall have right of entry to any site of contract performance to inspect or investigate the matter of compliance with the construction safety and health standards and to carry out the duties of the Secretary under Section 107 of the Contract Work Hours and Safety Standards Act (40 U.S.C. 3704).

**VIII. FALSE STATEMENTS CONCERNING HIGHWAY PROJECTS**

This provision is applicable to all Federal-aid construction contracts and to all related subcontracts.

In order to assure high quality and durable construction in conformity with approved plans and specifications and a high degree of reliability on statements and representations made by engineers, contractors, suppliers, and workers on Federal- aid highway projects, it is essential that all persons concerned with the project perform their functions as carefully, thoroughly, and honestly as possible. Willful falsification, distortion, or misrepresentation with respect to any facts related to the project is a violation of Federal law. To prevent any misunderstanding regarding the seriousness of these and

**ORDER NO.: 247**  
**CONTRACT ID. NO.: CM224PMF123441B**

similar acts, Form FHWA-1022 shall be posted on each Federal-aid highway project (23 CFR Part 635) in one or more places where it is readily available to all persons concerned with the project:

18 U.S.C. 1020 reads as follows:

"Whoever, being an officer, agent, or employee of the United States, or of any State or Territory, or whoever, whether a person, association, firm, or corporation, knowingly makes any false statement, false representation, or false report as to the character, quality, quantity, or cost of the material used or to be used, or the quantity or quality of the work performed or to be performed, or the cost thereof in connection with the submission of plans, maps, specifications, contracts, or costs of construction on any highway or related project submitted for approval to the Secretary of Transportation; or

Whoever knowingly makes any false statement, false representation, false report or false claim with respect to the character, quality, quantity, or cost of any work performed or to be performed, or materials furnished or to be furnished, in connection with the construction of any highway or related project approved by the Secretary of Transportation; or

Whoever knowingly makes any false statement or false representation as to material fact in any statement, certificate, or report submitted pursuant to provisions of the Federal-aid Roads Act approved July 11, 1916, (39 Stat. 355), as amended and supplemented;

Shall be fined under this title or imprisoned not more than 5 years or both."

**IX. IMPLEMENTATION OF CLEAN AIR ACT AND FEDERAL WATER POLLUTION CONTROL ACT (42 U.S.C. 7606; 2CFR 200.88; EO 11738)**

This provision is applicable to all Federal-aid construction contracts in excess of \$150,000 and to all related subcontracts. 48 CFR 2.101; 2 CFR 200.327.

By submission of this bid/proposal or the execution of this contract or subcontract, as appropriate, the bidder, proposer, Federal-aid construction contractor, subcontractor, supplier, or vendor agrees to comply with all applicable standards, orders or regulations issued pursuant to the Clean Air Act (42 U.S.C. 7401-7671q) and the Federal Water Pollution Control Act, as amended (33 U.S.C. 1251-1387). Violations must be reported to the Federal Highway Administration and the Regional Office of the Environmental Protection Agency. 2 CFR Part 200, Appendix II.

The contractor agrees to include or cause to be included the requirements of this Section in every subcontract, and further agrees to take such action as the contracting agency may direct as a means of enforcing such requirements. 2 CFR 200.327.

**X.CERTIFICATION REGARDING DEBARMENT, SUSPENSION, INELIGIBILITY AND VOLUNTARY EXCLUSION**

This provision is applicable to all Federal-aid construction contracts, design-build contracts, subcontracts, lower-tier subcontracts, purchase orders, lease agreements, consultant contracts or any



**ORDER NO.: 247**  
**CONTRACT ID. NO.: CM224PMF123441B**

other covered transaction requiring FHWA approval or that is estimated to cost \$25,000 or more – as defined in 2 CFR Parts 180 and 1200. 2 CFR 180.220 and 1200.220.

**1. Instructions for Certification – First Tier Participants:**

a. By signing and submitting this proposal, the prospective first tier participant is providing the certification set out below.

b. The inability of a person to provide the certification set out below will not necessarily result in denial of participation in this covered transaction. The prospective first tier participant shall submit an explanation of why it cannot provide the certification set out below. The certification or explanation will be considered in connection with the department or agency's determination whether to enter into this transaction. However, failure of the prospective first tier participant to furnish a certification or an explanation shall disqualify such a person from participation in this transaction. 2 CFR 180.320.

c. The certification in this clause is a material representation of fact upon which reliance was placed when the contracting agency determined to enter into this transaction. If it is later determined that the prospective participant knowingly rendered an erroneous certification, in addition to other remedies available to the Federal Government, the contracting agency may terminate this transaction for cause of default. 2 CFR 180.325.

d. The prospective first tier participant shall provide immediate written notice to the contracting agency to whom this proposal is submitted if any time the prospective first tier participant learns that its certification was erroneous when submitted or has become erroneous by reason of changed circumstances. 2 CFR 180.345 and 180.350.

e. The terms "covered transaction," "debarred," "suspended," "ineligible," "participant," "person," "principal," and "voluntarily excluded," as used in this clause, are defined in 2 CFR Parts 180, Subpart I, 180.900-180.1020, and 1200. "First Tier Covered Transactions" refers to any covered transaction between a recipient or subrecipient of Federal funds and a participant (such as the prime or general contract). "Lower Tier Covered Transactions" refers to any covered transaction under a First Tier Covered Transaction (such as subcontracts). "First Tier Participant" refers to the participant who has entered into a covered transaction with a recipient or subrecipient of Federal funds (such as the prime or general contractor). "Lower Tier Participant" refers any participant who has entered into a covered transaction with a First Tier Participant or other Lower Tier Participants (such as subcontractors and suppliers).

f. The prospective first tier participant agrees by submitting this proposal that, should the proposed covered transaction be entered into, it shall not knowingly enter into any lower tier covered transaction with a person who is debarred, suspended, declared ineligible, or voluntarily excluded from participation in this covered transaction, unless authorized by the department or agency entering into this transaction. 2 CFR 180.330.

g. The prospective first tier participant further agrees by submitting this proposal that it will include the clause titled "Certification Regarding Debarment, Suspension, Ineligibility and Voluntary Exclusion-Lower Tier Covered Transactions," provided by the department or contracting agency, entering into this covered transaction, without modification, in all lower tier covered transactions and in all solicitations for lower tier covered transactions exceeding the \$25,000 threshold. 2 CFR 180.220 and 180.300.

**ORDER NO.: 247**  
**CONTRACT ID. NO.: CM224PMF123441B**

h. A participant in a covered transaction may rely upon a certification of a prospective participant in a lower tier covered transaction that is not debarred, suspended, ineligible, or voluntarily excluded from the covered transaction, unless it knows that the certification is erroneous. 2 CFR 180.300; 180.320, and 180.325. A participant is responsible for ensuring that its principals are not suspended, debarred, or otherwise ineligible to participate in covered transactions. 2 CFR 180.335. To verify the eligibility of its principals, as well as the eligibility of any lower tier prospective participants, each participant may, but is not required to, check the System for Award Management website (<https://www.sam.gov/>). 2 CFR 180.300, 180.320, and 180.325.

i. Nothing contained in the foregoing shall be construed to require the establishment of a system of records in order to render in good faith the certification required by this clause. The knowledge and information of the prospective participant is not required to exceed that which is normally possessed by a prudent person in the ordinary course of business dealings.

j. Except for transactions authorized under paragraph (f) of these instructions, if a participant in a covered transaction knowingly enters into a lower tier covered transaction with a person who is suspended, debarred, ineligible, or voluntarily excluded from participation in this transaction, in addition to other remedies available to the Federal Government, the department or agency may terminate this transaction for cause or default. 2 CFR 180.325.

\* \* \* \* \*

**2. Certification Regarding Debarment, Suspension, Ineligibility and Voluntary Exclusion – First Tier Participants:**

a. The prospective first tier participant certifies to the best of its knowledge and belief, that it and its principals:

(1) Are not presently debarred, suspended, proposed for debarment, declared ineligible, or voluntarily excluded from participating in covered transactions by any Federal department or agency, 2 CFR 180.335;.

(2) Have not within a three-year period preceding this proposal been convicted of or had a civil judgment rendered against them for commission of fraud or a criminal offense in connection with obtaining, attempting to obtain, or performing a public (Federal, State, or local) transaction or contract under a public transaction; violation of Federal or State antitrust statutes or commission of embezzlement, theft, forgery, bribery, falsification or destruction of records, making false statements, or receiving stolen property, 2 CFR 180.800;

(3) Are not presently indicted for or otherwise criminally or civilly charged by a governmental entity (Federal, State or local) with commission of any of the offenses enumerated in paragraph (a)(2) of this certification, 2 CFR 180.700 and 180.800; and

(4) Have not within a three-year period preceding this application/proposal had one or more public transactions (Federal, State or local) terminated for cause or default. 2 CFR 180.335(d).

(5) Are not a corporation that has been convicted of a felony violation under any Federal law within the two-year period preceding this proposal (USDOT Order 4200.6 implementing appropriations act requirements); and

(6) Are not a corporation with any unpaid Federal tax liability that has been assessed, for which all

**ORDER NO.: 247**  
**CONTRACT ID. NO.: CM224PMF123441B**

judicial and administrative remedies have been exhausted, or have lapsed, and that is not being paid in a timely manner pursuant to an agreement with the authority responsible for collecting the tax liability (USDOT Order 4200.6 implementing appropriations act requirements).

b. Where the prospective participant is unable to certify to any of the statements in this certification, such prospective participant should attach an explanation to this proposal. 2 CFR 180.335 and 180.340.

\* \* \* \* \*

**3. Instructions for Certification - Lower Tier Participants:**

(Applicable to all subcontracts, purchase orders, and other lower tier transactions requiring prior FHWA approval or estimated to cost \$25,000 or more - 2 CFR Parts 180 and 1200). 2 CFR 180.220 and 1200.220.

a. By signing and submitting this proposal, the prospective lower tier participant is providing the certification set out below.

b. The certification in this clause is a material representation of fact upon which reliance was placed when this transaction was entered into. If it is later determined that the prospective lower tier participant knowingly rendered an erroneous certification, in addition to other remedies available to the Federal Government, the department, or agency with which this transaction originated may pursue available remedies, including suspension and/or debarment.

c. The prospective lower tier participant shall provide immediate written notice to the person to which this proposal is submitted if at any time the prospective lower tier participant learns that its certification was erroneous by reason of changed circumstances. 2 CFR 180.365.

d. The terms "covered transaction," "debarred," "suspended," "ineligible," "participant," "person," "principal," and "voluntarily excluded," as used in this clause, are defined in 2 CFR Parts 180, Subpart I, 180.900 – 180.1020, and 1200. You may contact the person to which this proposal is submitted for assistance in obtaining a copy of those regulations. "First Tier Covered Transactions" refers to any covered transaction between a recipient or subrecipient of Federal funds and a participant (such as the prime or general contract). "Lower Tier Covered Transactions" refers to any covered transaction under a First Tier Covered Transaction (such as subcontracts). "First Tier Participant" refers to the participant who has entered into a covered transaction with a recipient or subrecipient of Federal funds (such as the prime or general contractor). "Lower Tier Participant" refers any participant who has entered into a covered transaction with a First Tier Participant or other Lower Tier Participants (such as subcontractors and suppliers).

e. The prospective lower tier participant agrees by submitting this proposal that, should the proposed covered transaction be entered into, it shall not knowingly enter into any lower tier covered transaction with a person who is debarred, suspended, declared ineligible, or voluntarily excluded from participation in this covered transaction, unless authorized by the department or agency with which this transaction originated. 2 CFR 1200.220 and 1200.332.

f. The prospective lower tier participant further agrees by submitting this proposal that it will include this clause titled "Certification Regarding Debarment, Suspension, Ineligibility and Voluntary Exclusion-Lower Tier Covered Transaction," without modification, in all lower tier covered transactions and in all

**ORDER NO.: 247**  
**CONTRACT ID. NO.: CM224PMF123441B**

solicitations for lower tier covered transactions exceeding the \$25,000 threshold. 2 CFR 180.220 and 1200.220.

g. A participant in a covered transaction may rely upon a certification of a prospective participant in a lower tier covered transaction that is not debarred, suspended, ineligible, or voluntarily excluded from the covered transaction, unless it knows that the certification is erroneous. A participant is responsible for ensuring that its principals are not suspended, debarred, or otherwise ineligible to participate in covered transactions. To verify the eligibility of its principals, as well as the eligibility of any lower tier prospective participants, each participant may, but is not required to, check the System for Award Management website (<https://www.sam.gov/>), which is compiled by the General Services Administration. 2 CFR 180.300, 180.320, 180.330, and 180.335.

h. Nothing contained in the foregoing shall be construed to require establishment of a system of records in order to render in good faith the certification required by this clause. The knowledge and information of participant is not required to exceed that which is normally possessed by a prudent person in the ordinary course of business dealings.

i. Except for transactions authorized under paragraph e of these instructions, if a participant in a covered transaction knowingly enters into a lower tier covered transaction with a person who is suspended, debarred, ineligible, or voluntarily excluded from participation in this transaction, in addition to other remedies available to the Federal Government, the department or agency with which this transaction originated may pursue available remedies, including suspension and/or debarment. 2 CFR 180.325.

\* \* \* \* \*

**4. Certification Regarding Debarment, Suspension, Ineligibility and Voluntary Exclusion--  
Lower Tier Participants:**

a. The prospective lower tier participant certifies, by submission of this proposal, that neither it nor its principals:

(1) is presently debarred, suspended, proposed for debarment, declared ineligible, or voluntarily excluded from participating in covered transactions by any Federal department or agency, 2 CFR 180.355;

(2) is a corporation that has been convicted of a felony violation under any Federal law within the two-year period preceding this proposal (USDOT Order 4200.6 implementing appropriations act requirements); and

(3) is a corporation with any unpaid Federal tax liability that has been assessed, for which all judicial and administrative remedies have been exhausted, or have lapsed, and that is not being paid in a timely manner pursuant to an agreement with the authority responsible for collecting the tax liability. (USDOT Order 4200.6 implementing appropriations act requirements)

b. Where the prospective lower tier participant is unable to certify to any of the statements in this certification, such prospective participant should attach an explanation to this proposal.

\* \* \* \* \*

**ORDER NO.: 247**  
**CONTRACT ID. NO.: CM224PMF123441B**

**XI. CERTIFICATION REGARDING USE OF CONTRACT FUNDS FOR LOBBYING**

This provision is applicable to all Federal-aid construction contracts and to all related subcontracts which exceed \$100,000. 49 CFR Part 20, App. A.

1. The prospective participant certifies, by signing and submitting this bid or proposal, to the best of his or her knowledge and belief, that:

a. No Federal appropriated funds have been paid or will be paid, by or on behalf of the undersigned, to any person for influencing or attempting to influence an officer or employee of any Federal agency, a Member of Congress, an officer or employee of Congress, or an employee of a Member of Congress in connection with the awarding of any Federal contract, the making of any Federal grant, the making of any Federal loan, the entering into of any cooperative agreement, and the extension, continuation, renewal, amendment, or modification of any Federal contract, grant, loan, or cooperative agreement.

b. If any funds other than Federal appropriated funds have been paid or will be paid to any person for influencing or attempting to influence an officer or employee of any Federal agency, a Member of Congress, an officer or employee of Congress, or an employee of a Member of Congress in connection with this Federal contract, grant, loan, or cooperative agreement, the undersigned shall complete and submit Standard Form-LLL, "Disclosure Form to Report Lobbying," in accordance with its instructions.

2. This certification is a material representation of fact upon which reliance was placed when this transaction was made or entered into. Submission of this certification is a prerequisite for making or entering into this transaction imposed by 31 U.S.C. 1352. Any person who fails to file the required certification shall be subject to a civil penalty of not less than \$10,000 and not more than \$100,000 for each such failure.

3. The prospective participant also agrees by submitting its bid or proposal that the participant shall require that the language of this certification be included in all lower tier subcontracts, which exceed \$100,000 and that all such recipients shall certify and disclose accordingly.

**XII. USE OF UNITED STATES-FLAG VESSELS:**

This provision is applicable to all Federal-aid construction contracts, design-build contracts, subcontracts, lower-tier subcontracts, purchase orders, lease agreements, or any other covered transaction. 46 CFR Part 381.

This requirement applies to material or equipment that is acquired for a specific Federal-aid highway project. 46 CFR 381.7. It is not applicable to goods or materials that come into inventories independent of an FHWA funded-contract.

When oceanic shipments (or shipments across the Great Lakes) are necessary for materials or equipment acquired for a specific Federal-aid construction project, the bidder, proposer, contractor, subcontractor, or vendor agrees:

1. To utilize privately owned United States-flag commercial vessels to ship at least 50 percent of the gross tonnage (computed separately for dry bulk carriers, dry cargo liners, and tankers) involved, whenever shipping any equipment, material, or commodities pursuant to this contract, to the extent

**ORDER NO.: 247**  
**CONTRACT ID. NO.: CM224PMF123441B**

such vessels are available at fair and reasonable rates for United States-flag commercial vessels. 46 CFR 381.7.

2. To furnish within 20 days following the date of loading for shipments originating within the United States or within 30 working days following the date of loading for shipments originating outside the United States, a legible copy of a rated, 'on-board' commercial ocean bill-of-lading in English for each shipment of cargo described in paragraph (b)(1) of this section to both the Contracting Officer (through the prime contractor in the case of subcontractor bills-of-lading) and to the Office of Cargo and Commercial Sealift (MAR-620), Maritime Administration, Washington, DC 20590. (MARAD requires copies of the ocean carrier's (master) bills of lading, certified onboard, dated, with rates and charges. These bills of lading may contain business sensitive information and therefore may be submitted directly to MARAD by the Ocean Transportation Intermediary on behalf of the contractor). 46 CFR 381.7.

**ATTACHMENT A - EMPLOYMENT AND MATERIALS PREFERENCE FOR APPALACHIAN DEVELOPMENT HIGHWAY SYSTEM OR APPALACHIAN LOCAL ACCESS ROAD CONTRACTS** (23 CFR 633, Subpart B, Appendix B) This provision is applicable to all Federal-aid projects funded under the Appalachian Regional Development Act of 1965.

1. During the performance of this contract, the contractor undertaking to do work which is, or reasonably may be, done as on-site work, shall give preference to qualified persons who regularly reside in the labor area as designated by the DOL wherein the contract work is situated, or the subregion, or the Appalachian counties of the State wherein the contract work is situated, except:

- a. To the extent that qualified persons regularly residing in the area are not available.
- b. For the reasonable needs of the contractor to employ supervisory or specially experienced personnel necessary to assure an efficient execution of the contract work.
- c. For the obligation of the contractor to offer employment to present or former employees as the result of a lawful collective bargaining contract, provided that the number of nonresident persons employed under this subparagraph (1c) shall not exceed 20 percent of the total number of employees employed by the contractor on the contract work, except as provided in subparagraph (4) below.

2. The contractor shall place a job order with the State Employment Service indicating (a) the classifications of the laborers, mechanics and other employees required to perform the contract work, (b) the number of employees required in each classification, (c) the date on which the participant estimates such employees will be required, and (d) any other pertinent information required by the State Employment Service to complete the job order form. The job order may be placed with the State Employment Service in writing or by telephone. If during the course of the contract work, the information submitted by the contractor in the original job order is substantially modified, the participant shall promptly notify the State Employment Service.

3. The contractor shall give full consideration to all qualified job applicants referred to him by the State Employment Service. The contractor is not required to grant employment to any job applicants who, in his opinion, are not qualified to perform the classification of work required.

4. If, within one week following the placing of a job order by the contractor with the State Employment Service, the State Employment Service is unable to refer any qualified job applicants to the contractor, or less than the number requested, the State Employment Service will forward a certificate to the contractor indicating the unavailability of applicants. Such certificate shall be made a part of the contractor's permanent project records. Upon receipt of this certificate, the contractor may employ

**ORDER NO.: 247**  
**CONTRACT ID. NO.: CM224PMF123441B**

persons who do not normally reside in the labor area to fill positions covered by the certificate, notwithstanding the provisions of subparagraph (1c) above.

5. The provisions of 23 CFR 633.207(e) allow the contracting agency to provide a contractual preference for the use of mineral resource materials native to the Appalachian region.

6. The contractor shall include the provisions of Sections 1 through 4 of this Attachment A in every subcontract for work which is, or reasonably may be, done as on-site work.

**ORDER NO.: 247**  
**CONTRACT ID. NO.: CM224PMF123441B**

[SP0F0-000150-01](#)

July 17, 2017

VIRGINIA DEPARTMENT OF TRANSPORTATION  
SPECIAL PROVISION FOR  
**NOTICE OF REQUIREMENT FOR AFFIRMATIVE ACTION TO ENSURE  
EQUAL EMPLOYMENT OPPORTUNITY (EXECUTIVE ORDER 11246)**

1. The Offeror's or Bidder's attention is called to the "Equal Opportunity Clause" and the "Standard Federal Equal Employment Opportunity Construction Contract Specifications" set forth herein.
2. The goals for female and minority participation, expressed in percentage terms of the Contractor's aggregate work force in each trade on all construction works in the covered area, are as follows:

Females- 6.9%  
Minorities - See Attachment "A"

The goals are applicable to all the Contractor's construction work performed in the covered area, whether or not it is Federal or federally assisted. If the Contractor performs construction work in a geographical area located outside of the covered area, it shall apply the goals established for such geographical area where the work is actually performed. With regard to this second area, the Contractor also is subject to the goals for both its federally involved and non-federally involved construction.

The Contractor's compliance with the Executive Order and the regulations in 41 CFR Part 60-4 shall be based on its implementation of the Equal Opportunity Clause, specific affirmative action obligations required by the specifications, set forth in 41 CFR 60-4.3(a), and its efforts to meet the goals established herein. The hours of minority and female employment and training must be substantially uniform throughout the length of the Contract, and in each trade, and the Contractor shall make a good faith effort to employ minorities and women evenly on each of its projects. The transfer of minority or female employees or trainees from Contractor to Contractor or from project to project for the sole purpose of meeting the Contractor's goals shall be a violation of the Contract, the Executives Order and the regulations in 41 CFR Part 60-4. Compliance with the goals will be measured against the total work hours performed.

3. The Contractor shall provide written notification to the Director of the Office of Federal Contract Compliance Programs within 10 working days the award of any construction subcontract in excess of \$10,000 at any tier for construction works under this contract. The notification shall list the name, address and telephone number of the subcontractor, employer identification number, estimated dollar amount of the subcontract, estimated starting and completion dates of the subcontract and the geographical area in which the Contract is to be performed.

**STANDARD FEDERAL EQUAL EMPLOYMENT OPPORTUNITY  
CONSTRUCTION CONTRACT SPECIFICATIONS (EXECUTIVE ORDER 11246)**

1. As, used in this provision:
  - a. "Covered area" means the geographical area described in the solicitation from which this contract resulted;
  - b. "Director" means Director, Office of Federal Contract Compliance Programs, United States Department of Labor, or any person to whom the Director delegates authority;
  - c. "Employer identification number" means the Federal Social Security number used on the Employer's Quarterly Federal Tax Return, U. S. Treasury Department Form 941;
  - d. "Minority" includes:



**ORDER NO.: 247**  
**CONTRACT ID. NO.: CM224PMF123441B**

- (i) Black (all persons having origins in any of the Black African racial groups not of Hispanic origin);
  - (ii) Hispanic (all persons of Mexican, Puerto Rican, Cuban, Central or South American or other Spanish Culture or origin, regardless of race);
  - (iii) Asian and Pacific Islander (all persons having origins in any of the original peoples of the Far East, Southeast Asia, the Indian Subcontinent, or the Pacific Islands); and
  - (iv) American Indian or Alaskan Native (all persons having origins in any of the original peoples of North America and maintaining identifiable tribal affiliations through membership and participation or community identification).
2. Whenever the Contractor, or any Subcontractor at any tier, subcontracts a portion of the work involving any construction trade, it shall physically include in each subcontract in excess of \$10,000 the provisions of these specifications and the Notice which contains the applicable goals for minority and female participation.
  3. If the Contractor is participating (pursuant to 41 CFR 60-4.5) in a Hometown Plan approved by the U. S. Department of Labor in the covered area either individually or through an association, its affirmative action obligations on all work in the Plan area (including goals and timetables) shall be in accordance with that Plan for those trades which have unions participating in the Plan. Contractors must be able to demonstrate their participation in and compliance with the provisions of any such Hometown Plan. Each Contractor or Subcontractor participating in an approved Plan is individually required to comply with its obligations under the EEO clause, and to make a good faith effort to achieve each goal under the Plan in each trade in which it has employees. The overall good faith performance by other Contractors and Subcontractors toward a goal in an approved Plan does not excuse any covered Contractor's or Subcontractor's failure to take good faith efforts to achieve the Plan goals and timetables.
  4. The Contractor shall implement the specific affirmative action standards provided in paragraphs 7 a through p of these specifications. The goals set forth in the solicitation from which this contract resulted are expressed as percentages of the total hours of employment and training of minority and female utilization the Contractor should reasonably be able to achieve in each construction trade in which it has employees in the covered area. Covered construction Contractors performing construction work in geographical areas where they do not have a Federal or federally assisted construction contract shall apply the minority and female goals established for the geographical area where the work is being performed. Goals are published periodically in the Federal Register in notice form, and such notices may be obtained from any Office of Federal Contract Compliance Programs office or from Federal procurement contracting officers. The Contractor is expected to make substantially uniform progress in meeting its goals in each craft during the period specified.
  5. Neither the provisions of any collective bargaining agreement, nor the failure by a union with whom the Contractor has a collective bargaining agreement, to refer either minorities or women shall excuse the Contractor's obligations under these specifications, Executive Order 11246, or the regulations promulgated pursuant thereto.
  6. In order for the nonworking training hours of apprentices and trainees to be counted in meeting the goals, such apprentices and trainees must be employed by the Contractor during the training period, and the Contractor must have made a commitment to employ the apprentices and trainees at the completion of their training, subject to the availability of employment opportunities. Trainees must be trained pursuant to training programs approved by the U. S. Department of Labor.
  7. The Contractor shall take specific affirmative actions to ensure equal employment opportunity. The evaluation of the Contractor's compliance with these specifications shall be based upon its effort to achieve maximum results from its actions. The Contractor shall document these efforts fully, and shall implement affirmative action steps at least as extensive as the following:

**ORDER NO.: 247**  
**CONTRACT ID. NO.: CM224PMF123441B**

- a. Ensure and maintain a working environment free of harassment, intimidation, and coercion at all sites, and in all facilities at which the Contractor's employees are assigned to work. The Contractor, where possible, shall assign two or more women to each construction project. The Contractor shall specifically ensure that all foreman, superintendents and other on-site supervisory personnel are aware of and carry out the Contractor's obligation to maintain such a working environment, with specific attention to minority or female individuals working at such sites in such facilities.
- b. Establish and maintain a current list of minority and female recruitment sources, provide written notification to minority and female recruitment sources and to community organizations when the Contractor or its unions have employment opportunities available, and maintain a record of the organizations' responses.
- c. Maintain a current file of the names, addresses and telephone numbers of each minority and female off the street applicant and minority or female referral from a union, a recruitment source or community organization and of what action was taken with respect to each such individual. If such individual was sent to the union hiring hall for referral and was not referred back to the Contractor by the union, or if referred, not employed by the Contractor, this shall be documented in the file with the reason therefore, along with whatever additional actions the Contractor may have taken.
- d. Provide immediate written notification to the Director when the union or unions which the Contractor has a collective bargaining agreement has not referred to the Contractor a minority person or women sent by the Contractor, or when the Contractor has other information that the union referral process has impeded the Contractor's efforts to meet its obligations.
- e. Develop on-the-job training opportunities and/or participate in training programs for the area which expressly include minorities and women, including upgrading programs and apprenticeship and trainee programs relevant to the Contractor's employment needs, especially those programs funded or approved by the Department of Labor. The Contractor shall provide notice of these programs to the sources complied under 7b above.
- f. Disseminate the Contractor's EEO policy by providing notice of the policy to unions and training programs and requesting their cooperation in assisting the Contractor in meeting its EEO obligations; by including it in any policy manual and collective bargaining agreement; by publicizing it in the company newspaper or annual report; by specific review of the policy with all management personnel and with all minority and female employees at least once a year; and by posting the company EEO policy on bulletin boards accessible to all employees at each location where construction work is performed.
- g. Review, at least annually, the company's EEO policy and affirmative action obligations under these specifications with all employees having any responsibility for hiring, assignment, layoff, termination, or other employment decisions including specific review of these items with onsite supervisory personnel such as Superintendents and General Foremen prior to the initiation of construction work at any job site. A written record shall be made and maintained identifying the time and place of these meetings, persons attending, subject matter discussed and disposition of the subject matter.
- h. Disseminate the Contractor's EEO policy externally by including in any news media advertisement that the Contractor is "An Equal Opportunity Employer" for minority and female, and providing written notification to and discussing the Contractor's EEO policy with other Contractors and Subcontractors with whom the Contractor does or anticipates doing business.
- i. Directs its recruitment efforts, both oral and written, to minority, female and community organizations, to schools with minority and female students and to minority and recruitment and training organizations serving the Contractor's recruitment area and employment needs. Not later than one month prior to the date for the acceptance of applications for apprenticeship or other training by recruitment source,

**ORDER NO.: 247**  
**CONTRACT ID. NO.: CM224PMF123441B**

the Contractor shall send written notification to organizations such as the above, describing the openings, screening procedures and tests to be used in the selection process.

- j. Encourage present minority and female employees to recruit other minority persons and women and, where reasonable, provide after school, summer and vacation employment to minority and female youth both on the site and in other areas of Contractor's workforce.
  - k. Validate all tests and other selection requirements where there is an obligation to do so under 41 CFR Part 60-3.
  - l. Conduct, at least annually, an inventory and evaluation of all minority and female personnel for promotional opportunities and encourage these employees to seek or to prepare for such opportunities through appropriate training or other means.
  - m. Ensure that seniority practices, job classifications, work assignments and other personnel practices, do not have a discriminatory effect by continually monitoring all personnel and employment related activities to ensure that the EEO policy and the Contractor's obligations under these specifications are being carried out.
  - n. Ensure that all facilities and company activities are nonsegregated, except that separate or single-user toilet and necessary changing facilities shall be provided to assure privacy between the sexes.
  - o. Document and maintain a record of all solicitations of offers for subcontracts from minority and female construction contractors and suppliers, including circulation of solicitations to minority and female contractor associations and other business associations.
  - p. Conduct a review, at least annually, of all supervisors' adherence to and performance under the Contractor's EEO policies and affirmative action obligations.
8. Contractors are encouraged to participate in voluntary associations which assist in fulfilling one or more of their affirmative action obligations (7a through p). The efforts of a contractor association, joint contractor-union, contractor-community, or other similar group of which the Contractor is a member and participant, may be asserted as fulfilling any one or more of its obligations under 7a through p of these Specifications provided that the Contractor actively participates in the group, makes every effort to assure that the group has a positive impact on the employment of minorities and women in the industry, ensures that the concrete benefits of the program are reflected in the Contractor's minority and female workforce participation, makes a good faith effort to meet its individual goals and timetables and can provide access to documentation which demonstrates the effectiveness of actions taken on behalf of the Contractor. The obligation to comply, however, is the Contractor's and failure of such a group to fulfill an obligation shall not be a defense for the Contractor's noncompliance.
9. Goals for women have been established. However, the Contractor IS required to provide equal employment opportunity and to take affirmative action for all minority groups, both male and female and all women, both minority and non-minority. Consequently, the Contractor may be in violation of the Executive Order if a particular group is employed in a substantially disparate manner, that is even though the Contractor has achieved its goals for women, the Contractor may be in violation of the Executive Order if a specific minority group of women is underutilized.
10. The Contractor shall not use the goals and timetables or affirmative action standards to discriminate against any person because of race, color, religion, sex, sexual orientation, gender identity, or national origin.
11. The Contractor shall not enter into any Subcontract with any person or firm debarred from Government contracts pursuant to Executive Order 11246.
12. The Contractor shall carry out such sanctions and penalties for violation of these specifications and the Equal Opportunity Clause, including suspension, termination and cancellation of existing subcontracts as

**ORDER NO.: 247**  
**CONTRACT ID. NO.: CM224PMF123441B**

may be imposed or ordered pursuant to Executive Order 11246, as amended, and its implementing regulations by the Office of Federal Contract Compliance Programs. Any Contractor who fails to carry out such sanctions and penalties shall be in violation of these specifications and Executive Order 11246, as amended.

13. The Contractor, in fulfilling its obligations under these specifications shall implement specific affirmative action steps, at least as extensive as those standards prescribed in paragraph 7 of these specifications, so as to achieve maximum results from its efforts to ensure equal employment opportunity. If the Contractor fails to comply with the requirements of the Executive Order, the implementing regulations, or these specifications, the Director will proceed in accordance with 41 CFR 60-4.8.
14. The Contractor shall designate and make known to the Department a responsible official as the EEO Officer to monitor all employment related activity, to ensure that the company EEO policy is being carried out, to submit reports relating to the provisions hereof as may be required by the Government and to keep records. Records shall at least include for each employee the name, address, telephone numbers, construction trade, union affiliation if any, employee identification number when assigned, social security number, race, sex, status (e.g., mechanic, apprentice, trainee, helper, or laborer), dates of changes in status, hours worked per week in the indicated trade, rate of pay, and locations at which the work was performed. Records shall be maintained in an easily understandable and retrievable form; however, to the degree that existing records satisfy this requirement, Contractors will not be required to maintain separate records.
15. Nothing herein provided shall be construed as a limitation upon the application of other laws which establish different standards of compliance or upon the application of requirements for the hiring of local or other area residents (e.g., those under the Public Works Employment Act of 1977 and the Community Development Block Grant Program).

**ATTACHMENT A**

<u>Economic Area</u>	<u>Goal (Percent)</u>
Virginia:	
021 Roanoke-Lynchburg, VA	
SMSA Counties:	
4640 Lynchburg, VA .....	19.3
VA Amherst; VA Appomattox; VA Campbell; VA Lynchburg	
6800 Roanoke, VA .....	10.2
VA Botetourt; VA Craig; VA Roanoke; VA Roanoke City; VA Salem	
Non-SMSA Counties .....	12.0
VA Alleghany; VA Augusta; VA Bath; VA Bedford; VA Bland; VA Carroll;	
VA Floyd; VA Franklin; VA Giles; VA Grayson; VA Henry; VA Highland;	
VA Montgomery; VA Nelson; VA Patrick; VA Pittsylvania; VA Pulaski;	
VA Rockbridge; VA Rockingham; VA Wythe; VA Bedford City; VA Buena	
Vista:	
VA Clifton Forge; VA Covington; VA Danville; VA Galax; VA Harrisonburg;	
VA Lexington; VA Martinsville; VA Radford; VA Staunton; VA Waynesboro;	
WV Pendleton.	
022 Richmond, VA	
SMSA Counties:	
6140 Petersburg - Colonial Heights - Hopewell, VA .....	30.6
VA Dinwiddie; VA Prince George; VA Colonial Heights; VA Hopewell;	
VA Petersburg.	
6760 Richmond, VA .....	24.9
VA Charles City; VA Chesterfield; VA Goochland, VA Hanover; VA	
Henrico; VA New Kent; VA Powhatan; VA Richmond.	

**ORDER NO.: 247**  
**CONTRACT ID. NO.: CM224PMF123441B**

Non-SMSA Counties .....	27.9
VA Albemarle; VA Amelia; VA Brunswick; VA Buckingham, VA Caroline; VA Charlotte; VA Cumberland; VA Essex; VA Fluvanna; VA Greene; VA Greensville; VA Halifax; VA King and Queen; VA King William; VA Lancaster; VA Louisa; VA Lunenburg; VA Madison; VA Mecklenburg; VA Northumberland; VA Nottoway; VA Orange; VA Prince Edward; VA Richmond VA Sussex; VA Charlottesville; VA Emporia; VA South Boston	
023 Norfolk - Virginia Beach - Newport News VA:	
SMSA Counties:	
5680 Newport News- Hampton, VA .....	27.1
VA Gloucester; VA James City; VA York; VA Hampton; VA Newport News; VA Williamsburg.	
5720 Norfolk - Virginia Beach - Portsmouth, VA - NC .....	26.6
NC Currituck; VA Chesapeake; VA Norfolk; VA Portsmouth; VA Suffolk; VA Virginia Beach.	
Non-SMSA Counties .....	29.7
NC Bertie; NC Camden; NC Chowan; NC Gates; NC Hertford; NC Pasquotank; NC Perquimans; VA Isle of Wight; VA Matthews; VA Middlesex; VA Southampton; VA Surry; VA Franklin.	
Washington, DC:	
020 Washington, DC.	
SMSA Counties:	
8840 Washington, DC - MD - VA .....	28.0
DC District of Columbia; MD Charles; MD Montgomery MD Prince Georges; VA Arlington; VA Fairfax; VA Loudoun; VA Prince William VA Alexandria; VA Fairfax City; VA Falls Church.	
Non- SMSA Counties .....	25.2
MD Calvert; MD Frederick; MD St. Marys; MD Washington; VA Clarke; VA Culpeper; VA Fauquier; VA Frederick; VA King George; VA Page; VA Rappahannock; VA Shenandoah; VA Spotsylvania; VA Stafford; VA Warren; VA Westmoreland; VA Fredericksburg; VA Winchester WV Berkeley; WV Grant; WV Hampshire; WV Hardy; WV Jefferson; WV Morgan.	
Tennessee:	
052 Johnson City - Kingsport - Bristol, TN - VA	
SMSA Counties:	
3630 Johnson City - Kingsport -Bristol, TN-VA .....	2.6
TN Carter; TN Hawkins; TN Sullivan; TN Washington; VA Scott; VA Washington; VA Bristol.	
Non-SMSA Counties .....	3.2
TN Greene; TN Johnson; VA Buchanan; VA Dickenson; VA Lee; VA Russell; VA Smyth; VA Tazewell; VA Wise; VA Norton; WV McDowell; WV Mercer.	
Maryland:	
019 Baltimore MD	
Non-SMSA Counties .....	23.6
MD Caroline; MD Dorchester; MD Kent; MD Queen Annes; MD Somerset; MD Talbot; MD Wicomico; MD Worcester; VA Accomack; VA Northampton.	

**ORDER NO.: 247**  
**CONTRACT ID. NO.: CM224PMF123441B**

[SP102-000120-00 \[formerly SP102-010100-00\]](#)

VIRGINIA DEPARTMENT OF TRANSPORTATION  
SPECIAL PROVISION FOR  
**NON-DISCRIMINATION IN EMPLOYMENT AND CONTRACTING PRACTICES**

January 10, 2017

**I. Description**

This Special Provision implements Executive Order 61, ensuring equal opportunity and access for all Virginians in state contracting and public services.

**II. Non-Discrimination**

The Contractor shall maintain a non-discrimination policy, which prohibits discrimination by the Contractor on the basis of race, sex, color, national origin, religion, sexual orientation, gender identity, age, political affiliation, disability, or veteran status. This policy shall be followed in all employment practices, subcontracting practices, and delivery of goods or services. The Contractor shall also include this requirement in all subcontracts valued over \$10,000.

**III. Measurement and Payment**

Conformance with this Special Provision will not be measured for individual payment, and will be considered incidental to the Work.

**ORDER NO.: 247**  
**CONTRACT ID. NO.: CM224PMF123441B**

[SP105-000100-00](#)

VIRGINIA DEPARTMENT OF TRANSPORTATION  
SPECIAL PROVISION FOR  
**INFORMAL PARTNERING**

January 14, 2008c; Reissued July 12, 2016

**I. DECLARATION AND DESCRIPTION**

The Virginia Department of Transportation (VDOT) is firmly committed to the formation of a partnering relationship with the Contractor, all subcontractors, suppliers, FHWA representatives; where appropriate, other federal agencies, local government officials, utilities representatives, law enforcement and public safety officials, consultants, and other stakeholders to effectively and efficiently manage and complete each construction or maintenance contract to the mutual and individual benefits and goals of all parties. Partnering is an approach to fulfilling this commitment where all parties to the contract, as well as individuals and entities associated with or otherwise affected by the contract, willingly agree to dedicate themselves by working together as a team to fulfill and complete the construction or maintenance contract in cost effective ways while preserving the highest standards of safety and quality called for by the Contract combined with the goals of on time/on budget completion. The approach must still allow for the fact that the members of the team share many common interests yet have differing authorities, interests, and objectives that must be accommodated for the project to be viewed as successful by all parties. It is recognized by VDOT that partnering is a relationship in which:

- Trust and open communications are encouraged and expected by all participants
- All parties move quickly to address and resolve issues at the lowest possible level by approaching problems from the perspectives and needs of all involved
- All parties have identified common goals and at the same time respect each other's individual goals and values
- Partners create an atmosphere conducive to cooperation and teamwork in finding better solutions to potential problems and issues at hand

**II. INFORMAL PARTNERING STRUCTURE**

It is the business intent of the Department that **informal** partnering will be required on **this** project, whereby the spirit and principles of partnering are practiced from onsite field personnel to executive level owners and employees. The VDOT Field Guide to Partnering available on the VDOT website <http://www.virginiadot.org/business/resources/partnerfinalallowres.pdf> will be the standard reference guide utilized to structure and guide partnering efforts. This guide will be systematically evaluated to incorporate better practices as our partnering efforts evolve. Of particular note is the need for effective and responsive communication between parties to the partnering relationship as emphasized in Section 105.03(d) of the Specifications.

Informal partnering need not require the services of a professional facilitator and may be conducted by the actual partnering participants themselves. Informal partnering, and more specifically the Partnering Charter, will not change the legal relationship of the parties to the Contract nor relieve either party from any of the terms of the Contract.

**III. PROCEDURES**

The following are general procedures for informal partnering and are not to be considered as inclusive or representative of procedural requirements for all projects. Participants shall consult the VDOT Field Guide for Partnering for assistance in developing specific guidelines to those efforts required for their individual projects.

**ORDER NO.: 247**  
**CONTRACT ID. NO.: CM224PMF123441B**

**Prior To Project Construction:** At least 5 days prior to or in connection with the preconstruction conference the Contractor shall attend a conference with the Engineer at which time he and the Engineer shall discuss the extent of the informal partnering efforts required for the project, how these have been accommodated in the Contractor's bid and the identity of expectations and stakeholders associated with the project. Informal partnering efforts require the Department and the Contractor to mutually choose a single person from among their collective staffs, or a trained facilitator to be responsible for leading all parties through the VDOT Field Guide to Partnering and any subsequent partnering efforts.

**Partnering Meetings During Project Construction:** In informal partnering efforts the Contractor shall provide a location for regularly scheduled partnering meetings during the construction period. Such meetings will be scheduled as deemed necessary by either party. The Contractor and VDOT will require the attendance of their key decision makers, including subcontractors and suppliers. Both the Contractor and VDOT shall also encourage the attendance of affected utilities, concerned businesses, local government and civic leaders or officials, residents, and consultants, which may vary at different times during the life of the Contract. The Department and the Contractor are to agree upon partnering invitees in advance of each meeting. Follow-up partnering workshops may be held throughout the duration of the project as deemed necessary by the Contractor and the Engineer.

**IV. MEASUREMENT AND PAYMENT**

**Informal Partnering**, because the extent to which certain partnering activities are pursued is at the Contractor's option, and may vary according to project complexity, work history between the parties, project duration, the Contractor's own unique methods, means, and schedule to execute and complete the work, etc.; will not be paid for as a separate bid item but all the costs associated with informal partnering efforts for the duration of the work shall be considered inclusive and incidental to the cost of other appropriate items.



**ORDER NO.: 247**  
**CONTRACT ID. NO.: CM224PMF123441B**

**SP107-000120-00**

VIRGINIA DEPARTMENT OF TRANSPORTATION  
SPECIAL PROVISION FOR  
**ELECTRONIC SUBMISSION OF PAYROLLS AND  
DBE SUBCONTRACTOR PAYMENT FOR FEDERALLY FUNDED PROJECTS**

January 21, 2020

**I. GENERAL REQUIREMENTS**

The Contractor and all Subcontractors shall submit all certified payrolls and subcontractor payments, including those made to Disadvantaged Business Enterprises (DBEs), using the AASHTOWare Project Civil Rights and Labor (CRL) system in accordance with this specification. The term “subcontractor” shall include all vendors subject to FHWA-1273.

The electronic payroll submission and subcontractor payments through the CRL system replaces the paper submission of the C-57 and C-63 forms otherwise required by Sections 107.14(m) and 107.15 of the Specifications.

**II. SYSTEM REQUIREMENTS**

The CRL system is web based. The Contractor shall ensure compatibility with the CRL system as necessary to successfully execute the Work. The CRL system works with Internet Explorer 11 or Google Chrome and requires the ability to read, create, and edit spreadsheets in the .xlsx file format.

The Contractor and Subcontractors will be granted access after submitting forms ITD-35 and ITD-36 for each individual user who requires an account. Only those firms with a required contract in the system should submit the Request Access form. The software is configured so that each firm will only be able see their specific contract information. There will only be one single sign-on process for multiple application access within the Department.

VDOT will provide access and link and a log-in identification (ID) for the CRL system to designated employees of the Contractor and approved subcontractors entered into the system for the contract. The log-in ID and password are unique to the designated employee and must not be shared with other employees. There are no fees associated with accessing the system or to receive a login ID.

The low bidders on Contract awards will be contacted by the State Civil Rights Manager after letting to begin the process for accessing the CRL system for them and their subcontractors. The State Civil Rights Manager will provide all training for entry of certified payrolls and DBE subcontractor payments in CRL.

The CRL website is located at:

[https://www.virginiadot.org/business/aashtoware\\_project\\_civil\\_rights\\_and\\_labor%E2%84%A2\\_crl\\_management\\_system.asp](https://www.virginiadot.org/business/aashtoware_project_civil_rights_and_labor%E2%84%A2_crl_management_system.asp).

**III. PROCEDURES**

**1. CERTIFIED PAYROLL & SUBCONTRACTOR DATA SUBMISSION FOR FEDERALLY FUNDED PROJECTS**

The Contractor and all subcontractors shall use the CRL system to provide VDOT electronic certified payrolls. The Contractor shall ensure that all subcontractors submit their certified payrolls into the system electronically.

**ORDER NO.: 247**  
**CONTRACT ID. NO.: CM224PMF123441B**

Electronic submittal of certified payrolls can be submitted using the following methods:

- Manually add, copy, or modify data into CRL;
- Import payroll data with the CRL payroll spreadsheet XML converter tool available at <https://xml.cloverleaf.net/spreadsheet/>
- Convert payroll system program data to Payroll XML and import it into the CRL system. Information on how to convert to payroll program data to an XML file can be located at <https://xml.cloverleaf.net/resourcekit/>;
- The Contractor may send, on behalf of a subcontractor, payroll payment information based on a signed, certified paper payroll through the Electronica Proxy Payroll Process. Import payroll data with the CRL payroll spreadsheet XML converter tool available at <https://xml.cloverleaf.net/spreadsheet/>.

The District Civil Rights Manager or Engineer may require at any time, in writing, certified paper copies of the payrolls conforming to FHWA 1273 from any or all contractors working on the project.

**2. DBE PAYMENT SUBMISSION REQUIREMENTS FOR FEDERALLY FUNDED PROJECTS**

The Contractor shall post payment to DBE firms listed on their C-111 towards meeting their contract DBE goal per Federal DBE regulations. The Contractor shall submit, and shall require each Subcontractor to provide, payment amounts relative to all DBE involvement on the project during the life of the Contract in which participation occurs, and verification is available. The Contractor shall post payments to DBEs in CRL within 7 days after receipt of payment from the Department. Subcontractors shall post payments to DBEs in CRL within 7 days after receipt of payment from the Contractor.

The District Civil Rights Manager may require at any time, in writing, proof of payments from any or all subcontractors working on the project related to contractor DBE payments. The Contractor shall enter all payments made to all subcontractors into the Payment area of CRL for each estimate.

DBE Payments shall be entered only for those business entities that are being utilized in conjunction with performing a Commercial Useful Function (CUF).

More information about the CRL system can be located at <https://www.aashtowareproject.org/index.php>.

**ORDER NO.: 247**  
**CONTRACT ID. NO.: CM224PMF123441B**

SP107-001510-02

VIRGINIA DEPARTMENT OF TRANSPORTATION  
SPECIAL PROVISION FOR  
**DBE REQUIREMENTS**

August 18, 2017

**SECTION 107 – LEGAL RESPONSIBILITIES** of the Specifications is revised as follows:

**Section 107.15 – Use of Small, Women-Owned, and Minority-Owned Business** is renamed **Use of Disadvantaged Business Enterprises (DBEs)** and replaced with the following:

**(a) Disadvantaged Business Enterprise (DBE) Program Requirements**

Any Contractor, subcontractor, supplier, DBE firm, and contract surety involved in the performance of work on a federal-aid contract shall comply with the terms and conditions of the United States Department of Transportation (USDOT) DBE Program as the terms appear in Part 26 of the Code of Federal Regulations (49 CFR as amended), the USDOT DBE Program regulations; and the Virginia Department of Transportation's (VDOT or the Department) Road and Bridge Specifications and DBE Program rules and regulations.

For the purposes of this provision, Contractor is defined as the Prime Contractor of the Contract; and sub-contractor is defined as any DBE supplier, manufacturer, or subcontractor performing work or furnishing material, supplies or services to the Contract. The Contractor shall physically include this same contract provision in every supply or work/service subcontract that it makes or executes with a subcontractor having work for which it intends to claim credit.

In accordance with 49 CFR Part 26 and VDOT's DBE Program requirements, the Contractor, for itself and for its subcontractors and suppliers, whether certified DBE firms or not, shall commit to complying fully with the auditing, record keeping, confidentiality, cooperation, and anti-intimidation or retaliation provisions contained in those federal and state DBE Program regulations. By bidding on this contract, and by accepting and executing this contract, the Contractor agrees to assume these contractual obligations and to bind the Contractor's subcontractors contractually to the same at the Contractor's expense.

The Contractor or subcontractor shall not discriminate on the basis of race, color, sex, sexual orientation, gender identity, or national origin in the performance of this contract. The Contractor shall carry out applicable requirements of 49 CFR Part 26 in the award, administration, and performance of this contract. Failure by the Contractor to carry out these requirements is a material breach of this contract, which will result in the termination of this contract or other such remedy, as VDOT deems appropriate.

All administrative remedies noted in this provision are automatic unless the Contractor exercises the right of appeal within the required timeframe(s) specified herein. Appeal requirements, processes, and procedures shall be in accordance with guidelines stated herein and current at the time of the proceedings. Where applicable, the Department will notify the Contractor of any changes to the appeal requirements, processes, and procedures after receiving notification of the Contractor's desire to appeal.

All time frames referenced in this provision are expressed in business days unless otherwise indicated. Should the expiration of any deadline fall on a weekend or holiday, such deadline will automatically be extended to the next normal business day.

**(b) DBE Certification**

**ORDER NO.: 247**  
**CONTRACT ID. NO.: CM224PMF123441B**

The only DBE firms eligible to perform work on a federal-aid contract for DBE contract goal credit are firms certified as Disadvantaged Business Enterprises by the Virginia Department of Small Business and Supplier Diversity (DSBSD) or the Metropolitan Washington Airports Authority (MWAA) in accordance with federal and VDOT guidelines. DBE firms must be certified in the specific work listed for DBE contract goal credit. A directory listing of certified DBE firms can be obtained from the Virginia Department of [Small Business and Supplier Diversity website: www.sbsd.virginia.gov](http://www.sbsd.virginia.gov).

**(c) Bank Services**

The Contractor and each subcontractor are encouraged to use the services of banks owned and controlled by socially and economically disadvantaged individuals. Such banking services and the fees charged for services typically will not be eligible for DBE Program contract goal credit. Such information is available from the VDOT's Internet Civil Rights Division website:  
[http://www.virginiadot.org/business/resources/Civil\\_Rights/VDOT\\_DBE\\_Program\\_Plan.pdf](http://www.virginiadot.org/business/resources/Civil_Rights/VDOT_DBE_Program_Plan.pdf)

**(d) DBE Program-Related Certifications Made by Bidders\Contractors**

By submitting a bid and by entering into any contract on the basis of that bid, the bidder/Contractor certifies to each of the following DBE Program-related conditions and assurances:

1. That the management and bidding officers of its firm agree to comply with the bidding and project construction and administration obligations of the USDOT DBE Program requirements and regulations of 49 CFR Part 26 as amended, and VDOT's Road and Bridge Specifications and DBE Program requirements and regulations.
2. Under penalty of perjury and other applicable penal law that it has complied with the DBE Program requirements in submitting the bid, and shall comply fully with these requirements in the bidding, award, and execution of the Contract.
3. To ensure that DBE firms have been given full and fair opportunity to participate in the performance of the Contract. The bidder certifies that all reasonable steps were, and will be, taken to ensure that DBE firms had, and will have, an opportunity to compete for and perform work on the Contract. The bidder further certifies that the bidder shall not discriminate on the basis of race, color, age, sex, sexual orientation, gender identity, or national origin in the performance of the Contract or in the award of any subcontract. Any agreement between a bidder and a DBE whereby the DBE promises not to provide quotations for performance of work to other bidders is prohibited.
4. As a bidder, good faith efforts were made to obtain DBE participation in the proposed contract at or above the goal for DBE participation established by VDOT. It has submitted as a part of its bid true, accurate, complete, and detailed documentation of the good faith efforts it performed to meet the Contract goal for DBE participation. The bidder, by signing and submitting its bid, certifies the DBE participation information submitted within the stated time thereafter is true, correct, and complete, and that the information provided includes the names of all DBE firms that will participate in the Contract, the specific line item(s) that each listed DBE firm will perform, and the creditable dollar amounts of the participation of each listed DBE. The specific line item must reference the VDOT line number and item number contained in the proposal.
5. The bidder further certifies, by signing its bid, it has committed to use each DBE firm listed for the specific work item shown to meet the Contract goal for DBE participation. Award of the Contract will be conditioned upon meeting these and other listed requirements of 49 CFR Part 26.53 and the contract documents. By signing the bid, the bidder certifies on work that it proposes to sublet; it has made good faith efforts to seek out and consider DBEs as potential subcontractors. The bidder shall contact DBEs to solicit their interest, capability, and prices in

**ORDER NO.: 247**  
**CONTRACT ID. NO.: CM224PMF123441B**

sufficient time to allow them to respond effectively, and shall retain on file proper documentation to substantiate its good faith efforts. Award of the Contract will be conditioned upon meeting these and other listed requirements of 49 CFR Part 26.53 and the contract documents.

6. Once awarded the Contract, the Contractor shall make good faith efforts to utilize DBE firms to perform work designated to be performed by DBEs at or above the amount or percentage of the dollar value specified in the bidding documents. Further, the Contractor understands it shall not unilaterally terminate, substitute for, or replace any DBE firm that was designated in the executed contract in whole or in part with another DBE, any non-DBE firm, or with the Contractor's own forces or those of an affiliate of the Contractor without the prior written consent of VDOT as set out within the requirements of this provision.
7. Once awarded the contract, the Contractor shall designate and make known to the Department a liaison officer who is assigned the responsibility of administering and promoting an active and inclusive DBE program as required by 49 CFR Part 26 for DBEs. The designation and identity of this officer need be submitted only once by the Contractor during any twelve (12) month period at the preconstruction conference for the first contract the Contractor has been awarded during that reporting period. The Department will post such information for informational and administrative purposes at VDOT's Internet Civil Rights Division website.
8. Once awarded the Contract, the Contractor shall comply fully with all regulatory and contractual requirements of the USDOT DBE Program, and that each DBE firm participating in the Contract shall fully perform the designated work items with the DBE's own forces and equipment under the DBE's direct supervision, control, and management. Where a contract exists and where the Contractor, DBE firm, or any other firm retained by the Contractor has failed to comply with federal or VDOT DBE Program regulations and/or their requirements on that contract, VDOT has the authority and discretion to determine the extent to which the DBE contract regulations and/or requirements have not been met, and will assess against the Contractor any remedies available at law or provided in the Contract in the event of such a contract breach.
9. In the event a bond surety assumes the completion of work, if for any reason VDOT has terminated the prime Contractor, the surety shall be obligated to meet the same DBE contract terms and requirements as were required of the original prime Contractor in accordance with the requirements of this specification.

**(e) Disqualification of Bidder**

Bidders may be disqualified from bidding for failure to comply with the requirements of this Special Provision, the Contract specifications, and VDOT Road and Bridge Specifications.

**(f) Bidding Procedures**

The following bidding procedures shall apply to the Contract for DBE Program compliance purposes:

1. **Contract Goal, Good Faith Efforts Specified:** All bidders evidencing the attainment of DBE goal commitment equal to or greater than the required DBE goal established for the project must submit completed Form C-111, Minimum DBE Requirements, and Form C-48, Subcontractor/Supplier Solicitation and Utilization, as a part of the bid documents.

Form C-111 may be submitted electronically or may be faxed to the Department, but in no case shall the bidder's Form C-111 be received later than 10:00 a.m. the next business day after the time stated in the bid proposal for the receipt of bids. Form C-48 must be received within ten (10) business days after the bid opening.

**ORDER NO.: 247**  
**CONTRACT ID. NO.: CM224PMF123441B**

If, at the time of submitting its bid, the bidder knowingly cannot meet or exceed the required DBE contract goal, it shall submit Form C-111 exhibiting the DBE participation it commits to attain as a part of its bid documents. The bidder shall then submit Form C-49, DBE Good Faith Efforts Documentation, within two (2) business days after the bid opening.

The lowest responsive and responsible bidder must submit its properly executed Form C-112, Certification of Binding Agreement, within three (3) business days after the bids are received. DBEs bidding as prime contractors are not required to submit Form C-112 unless they are utilizing other DBEs as subcontractors.

If, after review of the apparent lowest bid, VDOT determines the DBE requirements have not been met, the apparent lowest successful bidder must submit Form C-49, DBE Good Faith Efforts Documentation, which must be received by the Contract Engineer within two (2) business days after official notification of such failure to meet the aforementioned DBE requirements.

Forms C-48, C-49, C-111, and C-112 can be obtained from the VDOT website at:  
<http://vdotforms.vdot.virginia.gov/>

Instructions for submitting Form C-111 can be obtained from the VDOT website at:  
[http://www.virginiadot.org/business/resources/const/Exp\\_DBE\\_Commitments.pdf](http://www.virginiadot.org/business/resources/const/Exp_DBE_Commitments.pdf)

2. **Bid Rejection:** The failure of a bidder to submit the required documentation within the timeframes specified in the **Contract Goal, Good Faith Efforts Specified** section of this Special Provision may be cause for rejection of that bidder's bid.

If the lowest bidder is rejected for failure to submit the required documentation in the specified time frames, the Department may award the work to the next lowest bidder, or re-advertise the proposed work at a later date or proceed otherwise as determined by the Commonwealth.

3. **Good Faith Efforts Described:** In order to award a contract to a bidder that has failed to meet DBE contract goal requirements, VDOT will determine if the bidder's efforts were adequate good faith efforts, and if given all relevant circumstances, those efforts were made actively and aggressively to meet the DBE requirements. Efforts to obtain DBE participation are not good faith efforts if they could not reasonably be expected to produce a level of DBE participation sufficient to meet the DBE Program and contract goal requirements.

Good faith efforts may be determined through use of the following list of the types of actions the bidder may make to obtain DBE participation. This is not intended to be a mandatory checklist, nor is it intended to be exclusive or exhaustive. Other factors or types of efforts of similar intent may be relevant in appropriate cases:

- a. Soliciting through reasonable and available means, such as but not limited to, attendance at pre-bid meetings, advertising, and written notices to DBEs who have the capability to perform the work of the Contract. Examples include: advertising in at least one daily/weekly/monthly newspaper of general circulation, as applicable; phone contact with a completely documented telephone log, including the date and time called, contact person, or voice mail status; and internet contacts with supporting documentation, including dates advertised. The bidder shall solicit this interest no less than five (5) business days before the bids are due so that the solicited DBEs have enough time to reasonably respond to the solicitation. The bidder shall determine with certainty if the DBEs are interested by taking reasonable steps to follow up initial solicitations as evidenced by documenting such efforts as requested on Form C-49, DBE Good Faith Efforts Documentation.
- b. Selecting portions of the work to be performed by DBEs in order to increase the likelihood that the DBE goals will be achieved. This includes, where appropriate, breaking out

**ORDER NO.: 247**  
**CONTRACT ID. NO.: CM224PMF123441B**

contract work items into economically feasible units to facilitate DBE participation, even when the Contractor might otherwise prefer to completely perform all portions of this work in its entirety or use its own forces;

- c. Providing interested DBEs with adequate information about the plans, specifications, and requirements of the Contract in a timely manner, which will assist the DBEs in responding to a solicitation;
- d. Negotiating for participation in good faith with interested DBEs;
  - (1) Evidence of such negotiation shall include the names, addresses, and telephone numbers of DBEs that were considered; dates DBEs were contacted; a description of the information provided regarding the plans, specifications, and requirements of the Contract for the work selected for subcontracting; and, if insufficient DBE participation seems likely, evidence as to why additional agreements could not be reached for DBEs to perform the work;
  - (2) A bidder using good business judgment should consider a number of factors in negotiating with subcontractors, including DBE subcontractors, and should take a firm's price, qualifications, and capabilities, as well as contract goals, into consideration. However, the fact that there may be some additional costs involved in finding and using DBEs is not sufficient reason for a bidder's failure to meet the Contract goal for DBE participation, as long as such costs are reasonable and comparable to costs customarily appropriate to the type of work under consideration. Also, the ability or desire of a bidder to perform the work of a contract with its own organization does not relieve the bidder of the responsibility to make diligent good faith efforts. Bidders are not, however, required to accept higher quotes from DBEs if the price difference can be shown by the bidder to be excessive, unreasonable, or greater than would normally be expected by industry standards;
- e. A bidder cannot reject a DBE as being unqualified without sound reasons based on a thorough investigation of the DBE's capabilities. The DBE's standing within its industry, membership in specific groups, organizations, associations, and political or social affiliations, and union vs. non-union employee status are not legitimate causes for the rejection or non-solicitation of bids in the bidder's efforts to meet the project goal for DBE participation;
- f. Making efforts to assist interested DBEs in obtaining bonding, lines of credit, or insurance as required by VDOT or by the bidder/Contractor;
- g. Making efforts to assist interested DBEs in obtaining necessary equipment, supplies, materials, or related assistance or services subject to the restrictions contained in these provisions;
- h. Effectively using the services of appropriate personnel from VDOT and from DMBE; available minority/women community or minority organizations; contractors' groups; local, state, and Federal minority/ women business assistance offices; and other organizations as allowed on a case-by-case basis to provide assistance in the recruitment and utilization of qualified DBEs.

**(g) Documentation and Administrative Reconsideration of Good Faith Efforts**

**During Bidding:** As described in the **Contract Goal, Good Faith Efforts Specified** section of this Special Provision, the bidder must provide Form C-49, DBE Good Faith Efforts Documentation, of its efforts made to meet the DBE contract goal as proposed by VDOT within the time frame specified in this provision. The means of transmittal and the risk for timely receipt of this information shall be

**ORDER NO.: 247**  
**CONTRACT ID. NO.: CM224PMF123441B**

the responsibility of the bidder. The bidder shall attach additional pages to the certification, if necessary, in order to fully detail specific good faith efforts made to obtain the DBE firms participation in the proposed contract work.

However, regardless of the DBE contract goal participation level proposed by the bidder or the extent of good faith efforts shown, all bidders shall timely and separately file their completed and executed forms C-111, C-112, C-48, and C-49, as aforementioned, or face potential bid rejection.

If a bidder does not submit its completed and executed forms C-111, or C-112, when required by this Special Provision, the bidder's bid will be considered non-responsive and may be rejected.

Where the Department upon initial review of the bid results determines the apparent low bidder has failed or appears to have failed to meet the requirements of the **Contract Goal, Good Faith Efforts Specified** section of this Special Provision and has failed to adequately document that it made a good faith effort to achieve sufficient DBE participation as specified in the bid proposal, that firm upon notification of the Department's initial determination will be offered the opportunity for administrative reconsideration before VDOT rejects that bid as non-responsive. The bidder shall address such request for reconsideration in writing to the Contract Engineer within five (5) business days of receipt of notification by the Department and shall be given the opportunity to discuss the issue and present its evidence in person to the Administrative Reconsideration Panel. The Administrative Reconsideration Panel will be made up of VDOT Division Administrators or their designees, none of who took part in the initial determination that the bidder failed to make the goal or make adequate good faith efforts to do so. After reconsideration, VDOT shall notify the bidder in writing of its decision and explain the basis for finding that the bidder did or did not meet the goal or make adequate good faith efforts to do so.

If, after reconsideration, the Department determines the bidder has failed to meet the requirements of the Contract goal and has failed to make adequate good faith efforts to achieve the level of DBE participation as specified in the bid proposal, the bidder's bid will be rejected.

If sufficient documented evidence is presented to demonstrate that the apparent low bidder made reasonable good faith efforts, the Department will award the Contract and reduce the DBE requirement to the actual commitment identified by the lowest successful bidder at the time of its bid. The Contractor is still encouraged to seek additional DBE participation during the life of the Contract.

However, such action will not relieve the Contractor of its responsibility for complying with the reduced DBE requirement during the life of the Contract or any administrative sanctions as may be appropriate.

**During the Contract:** If a DBE, through no fault of the Contractor, is unable or unwilling to fulfill his agreement with the Contractor, the Contractor shall immediately notify the Department and provide all relevant facts. If a Contractor relieves a DBE subcontractor of the responsibility to perform work under their subcontract, the Contractor is encouraged to take the appropriate steps to obtain a DBE to perform an equal dollar value of the remaining subcontracted work. In such instances, the Contractor is expected to seek DBE participation towards meeting the goal during the performance of the Contract.

If the Contractor fails to conform to the schedule of DBE participation as shown on the progress schedule, or at any point at which it is clearly evident that the remaining dollar value of allowable credit for performing work is insufficient to obtain the scheduled participation, and the Contractor has not taken the preceding actions, the Contractor and any aforementioned affiliates may be subject to disallowance of DBE credit until such time as conformance with the schedule of DBE participation is achieved.



**ORDER NO.: 247**  
**CONTRACT ID. NO.: CM224PMF123441B**

**Project Completion:** If the Contractor fails upon completion of the project to meet the required participation, the Contractor and any prime contractual affiliates, as in the case of a joint venture, may be enjoined from bidding as a prime Contractor, or participating as a subcontractor on VDOT projects for a period of 90 days.

Prior to enjoinder from bidding or denial to participate as a subcontractor for failure to comply with participation requirements, as provided hereinbefore, the Contractor may submit documentation to the State Construction Engineer to substantiate that failure was due solely to quantitative underrun(s), elimination of items subcontracted to DBEs, or to circumstances beyond their control, and that all feasible means have been used to obtain the required participation. The State Construction Engineer upon verification of such documentation shall make a determination whether or not the Contractor has met the requirements of the Contract.

If it is determined that the aforementioned documentation is insufficient or the failure to meet required participation is due to other reasons, the Contractor may request an appearance before the Administrative Reconsideration Panel to establish that all feasible means were used to meet such participation requirements. The decision of the Administrative Reconsideration Panel shall be administratively final. If the decision is made to enjoin the Contractor from bidding on other VDOT work as described herein, the enjoinder period will begin upon the Contractor's failure to request a hearing within the designated time frame or upon the Administrative Reconsideration Panel's decision to enjoin, as applicable.

**(h) DBE Participation for Contract Goal Credit**

1. Cost-plus subcontracts will not be considered to be in accordance with normal industry practice and will not normally be allowed for credit.
2. The applicable percentage of the total dollar value of the Contract or Subcontract awarded to the DBE will be counted toward meeting the Contract goal for DBE participation in accordance with the **DBE Program-Related Certifications Made by Bidders\Contractors** section of this Special Provision for the value of the work, goods, or services that are actually performed or provided by the DBE firm itself or subcontracted by the DBE to other DBE firms.
3. When a DBE performs work as a participant in a joint venture with a non-DBE firm, the Contractor may count toward the DBE goal only that portion of the total dollar value of the Contract equal to the distinctly defined portion of the Contract work that the DBE has performed with the DBE's own forces or in accordance with the provisions of this Section. The Department shall be contacted in advance regarding any joint venture involving both a DBE firm and a non-DBE firm to coordinate Department review and approval of the joint venture's organizational structure and proposed operation where the Contractor seeks to claim the DBE's credit toward the DBE contract goal.
4. When a DBE subcontracts part of the work of the Contract to another firm, the value of that subcontracted work may be counted toward the DBE contract goal only if the DBE's subcontractor at a lower tier is a certified DBE. Work that a DBE subcontracts to either a non-DBE firm or to a non-certified DBE firm will not count toward the DBE contract goal. The cost of supplies and equipment a DBE subcontractor purchases or leases from the prime Contractor or the prime's affiliated firms will not count toward the Contract goal for DBE participation.
5. The Contractor may count expenditures to a DBE subcontractor toward the DBE contract goal only if the DBE performs a Commercially Useful Function (CUF) on that contract.
6. A Contractor may not count the participation of a DBE subcontractor toward the Contractor's final compliance with the DBE contract goal obligations until the amount being counted has actually been paid to the DBE. A Contractor may count sixty (60) percent of its expenditures actually paid for materials and supplies obtained from a DBE certified as a regular dealer, and

**ORDER NO.: 247**  
**CONTRACT ID. NO.: CM224PMF123441B**

one hundred (100) percent of such expenditures actually paid for materials and supplies obtained from a certified DBE manufacturer.

- a. For the purposes of this Special Provision, a regular dealer is defined as a firm that owns, operates, or maintains a store, warehouse, or other establishment in which the materials, supplies, articles, or equipment required and used under the Contract are bought, kept in stock, and regularly sold or leased to the public in the usual course of business. To be a regular dealer, the DBE firm shall be an established business that regularly engages, as its principal business and under its own name, in the purchase and sale or lease of the products or equipment in question. Packagers, brokers, manufacturers' representatives, or other persons who arrange or expedite transactions will not be considered regular dealers.
- b. A DBE firm may be a regular dealer in such bulk items as petroleum products, steel, cement, gravel, stone, or asphalt without owning, operating, or maintaining a place of business where it keeps such items in stock if the DBE both owns and operates distribution equipment for the products it sells and provides for the Contract work. Any supplementation of a regular dealer's own distribution equipment shall be by a long-term lease agreement and not on an *ad hoc* or contract-by-contract basis to be eligible for credit to meet the DBE contract goal.
- c. If a DBE regular dealer is used for DBE contract goal credit, no additional credit will be given for hauling or delivery to the project site goods or materials sold by that DBE regular dealer. Those delivery costs shall be deemed included in the price charged for the goods or materials by the DBE regular dealer, who shall be responsible for their distribution.
- d. For the purposes of this Special Provision, a manufacturer will be defined as a firm that operates or maintains a factory or establishment that produces on the premises the materials, supplies, articles, or equipment required under the Contract and of the general character described by the project specifications. A manufacturer shall include firms that produce finished goods or products from raw or unfinished material, or purchase and substantially alter goods and materials to make them suitable for construction use before reselling them.
- e. A Contractor may count toward the DBE contract goal the following expenditures to DBE firms that are not regular dealers or manufacturers for DBE program purposes:
  - (1) The entire amount of fees or commissions charged by a DBE firm for providing a bona fide service, such as professional, technical, consultant or managerial services, or for providing bonds or insurance specifically required for the performance of the federal-aid contract, if the fee is reasonable and not excessive or greater than would normally be expected by industry standards for the same or similar services.
  - (2) The entire amount of that portion of the construction contract that is performed by the DBE's own forces and equipment under the DBE's supervision. This includes the cost of supplies and materials ordered and paid for by the DBE for contract work, including supplies purchased or equipment leased by the DBE, except supplies and equipment a DBE subcontractor purchases or leases from the prime Contractor or its affiliates.
- f. A Contractor may count toward the DBE contract goal one hundred (100) percent of the fees paid to a DBE trucker or hauler for the delivery of material and supplies required on the project job site, but not for the cost of those materials or supplies themselves, provided that the trucking or hauling fee is determined by VDOT to be reasonable, as compared with fees customarily charged by non-DBE firms for similar services. A Contractor shall not count costs for the removal or relocation of excess material from or on the job site when the DBE trucking company is not the manufacturer of or a regular dealer in those materials

**ORDER NO.: 247**  
**CONTRACT ID. NO.: CM224PMF123441B**

and supplies. The DBE trucking firm shall also perform a Commercially Useful Function (CUF) on the project and not operate merely as a pass through for the purposes of gaining credit toward the DBE contract goal. Prior to submitting a bid, the Contractor shall determine, or contact the VDOT Civil Rights Division or its district Offices for assistance in determining, whether a DBE trucking firm will meet the criteria for performing a CUF on the project. See section on **Miscellaneous DBE Program Requirements; Factors used to Determine if a DBE Trucking Firm is Performing a CUF.**

- g. The Contractor will receive DBE contract goal credit for the fees or commissions charged by and paid to a DBE broker who arranges or expedites sales, leases, or other project work or service arrangements provided that those fees are determined by VDOT to be reasonable and not excessive as compared with fees customarily charged by non-DBE firms for similar services. For the purposes of this Special Provision, a broker is defined as a person or firm that regularly engages in arranging for delivery of material, supplies, and equipment, or regularly arranges for the providing of project services as a course of routine business but does not own or operate the delivery equipment necessary to transport materials, supplies, or equipment to or from a job site.

**(i) Performing a Commercially Useful Function (CUF)**

No credit toward the DBE contract goal will be allowed for contract payments or expenditures to a DBE firm if that DBE firm does not perform a CUF on that contract. A DBE performs a CUF when the DBE is solely responsible for execution of a distinct element of the Contract work and the DBE actually performs, manages, and supervises the work involved with the firm's own forces or in accordance with the provisions of the **DBE Participation for Contract Goal Credit** section of this Special Provision. To perform a CUF the DBE alone shall be responsible and bear the risk for the material and supplies used on the Contract, selecting a supplier or dealer from those available, negotiating price, determining quality and quantity, ordering the material and supplies, installing those materials with the DBE's own forces and equipment, and paying for those materials and supplies. The amount the DBE firm is to be paid under the Contract shall be commensurate with the work the DBE actually performs and the DBE credit claimed for the DBE's performance.

**Monitoring CUF Performance:** It shall be the Contractor's responsibility to ensure that all DBE firms selected for subcontract work on the Contract, for which he seeks to claim credit toward the Contract goal, perform a CUF. Further, the Contractor is responsible for and shall ensure that each DBE firm fully performs the DBE's designated tasks with the DBE's own forces and equipment under the DBE's own direct supervision and management or in accordance with the provisions of the **DBE Participation for Contract Goal Credit** section of this Special Provision. For the purposes of this provision the DBE's equipment will mean either equipment directly owned by the DBE as evidenced by title, bill of sale or other such documentation, or leased by the DBE, and over which the DBE has control as evidenced by the leasing agreement from a firm not owned in whole or part by the prime Contractor or an affiliate of the Contractor under this contract.

VDOT will monitor the Contractor's DBE involvement during the performance of the Contract. However, VDOT is under no obligation to warn the Contractor that a DBE's participation will not count toward the goal.

**DBEs Must Perform a Useful and Necessary Role in Contract Completion:** A DBE does not perform a commercially useful function if the DBE's role is limited to that of an extra participant in a transaction, contract, or project through which funds are passed in order to obtain the appearance of DBE participation.

**DBEs Must Perform The Contract Work With Their Own Workforces:** If a DBE does not perform and exercise responsibility for at least thirty (30) percent of the total cost of the DBE's contract with the DBE's own work force, or the DBE subcontracts a greater portion of the work of a contract than would be expected on the basis of normal industry practice for the type of work involve, VDOT will

**ORDER NO.: 247**  
**CONTRACT ID. NO.: CM224PMF123441B**

presume that the DBE is not performing a CUF and such participation will not be counted toward the Contract goal.

**VDOT Makes Final Determination On Whether a CUF Is Performed:** VDOT has the final authority to determine whether a DBE firm has performed a CUF on a federal-aid contract. To determine whether a DBE is performing or has performed a CUF, VDOT will evaluate the amount of work subcontracted by that DBE firm or performed by other firms and the extent of the involvement of other firms' forces and equipment. Any DBE work performed by the Contractor or by employees or equipment of the Contractor shall be subject to disallowance under the DBE Program, unless the independent validity and need for such an arrangement and work is demonstrated.

**(j) Verification of DBE Participation and Imposed Damages**

Within fourteen days after contract execution, the Contractor shall submit to the Responsible Engineer, with a copy to the District Civil Rights Office (DCRO), a fully executed subcontract agreement for each DBE used to claim credit in accordance with the requirements stated on Form C-112. The subcontract agreement shall be executed by both parties stating the work to be performed, the details or specifics concerning such work, and the price which will be paid to the DBE subcontractor. Because of the commercial damage that the Contractor and its DBE subcontractor could suffer if their subcontract pricing, terms, and conditions were known to competitors, the Department staff will treat subcontract agreements as proprietary Contractor trade secrets with regard to Freedom of Information Act requests. In lieu of subcontract agreements, purchase orders may be submitted for haulers, suppliers, and manufacturers. These too, will be treated confidentially and protected. Such purchase orders must contain, as a minimum, the following information: authorized signatures of both parties; description of the scope of work to include contract item numbers, quantities, and prices; and required federal contract provisions.

The Contractor shall also furnish, and shall require each subcontractor to furnish, information relative to all DBE involvement on the project for each quarter during the life of the Contract in which participation occurs and verification is available. The information shall be indicated on Form C-63, DBE and SWAM Payment Compliance Report. The department reserves the right to request proof of payment via copies of cancelled checks with appropriate identifying notations. Failure to provide Form C-63 to the District Civil Rights Office (DCRO) within five (5) business days after the reporting period may result in delay of approval of the Contractor's monthly progress estimate for payment. The names and certification numbers of DBE firms provided by the Contractor on the various forms indicated in this Special Provision shall be exactly as shown on the DMBE's or MWAA's latest list of certified DBEs. Signatures on all forms indicated herein shall be those of authorized representatives of the Contractor as shown on the Prequalification Application, Form C-32 or the Prequalification/Certification Renewal Application, Form C-32A, or authorized by letter from the Contractor. If DBE firms are used which have not been previously documented with the Contractor's bid and for which the Contractor now desires to claim credit toward the project goal, the Contractor shall be responsible for submitting necessary documentation in accordance with the procedures stipulated in this Special Provision to cover such work prior to the DBE beginning work.

Form C-63 can be obtained from the VDOT website at: <http://vdotforms.vdot.virginia.gov/>

The Contractor shall submit to the Responsible Engineer its progress schedule with a copy to the DCRO, as required by Section 108.03 of the Specifications or other such specific contract scheduling specification that may include contractual milestones, i.e., monthly or VDOT requested updates. The Contractor shall include a narrative of applicable DBE activities relative to work activities of the Contractor's progress schedule, including the approximate start times and durations of all DBE participation to be claimed for credit that shall result in full achievement of the DBE goal required in the Contract.

**ORDER NO.: 247**  
**CONTRACT ID. NO.: CM224PMF123441B**

On contracts awarded on the basis of good faith efforts, narratives or other agreeable format of schedule information requirements and subsequent progress determination shall be based on the commitment information shown on the latest Form C-111 as compared with the appropriate Form C-63.

Prior to beginning any major component or quarter of the work, as applicable, in which DBE work is to be performed, the Contractor shall furnish a revised Form C-111 showing the name(s) and certification number(s) of any current DBEs not previously submitted who will perform the work during that major component or quarter for which the Contractor seeks to claim credit toward the Contract DBE goal. The Contractor shall obtain the prior approval of the Department for any assistance it may provide to the DBE beyond its existing resources in executing its commitment to the work in accordance with the requirements listed in the **Good Faith Efforts Described** section of this Special Provision. If the Contractor is aware of any assistance beyond a DBE's existing resources that the Contractor, or another subcontractor, may be contemplating or may deem necessary and that have not been previously approved, the Contractor shall submit a new or revised narrative statement for VDOT's approval prior to assistance being rendered.

If the Contractor fails to comply with correctly completing and submitting any of the required documentation requested by this provision within the specified time frames, the Department will withhold payment of the monthly progress estimate until such time as the required submissions are received VDOT. Where such failures to provide required submittals or documentation are repeated the Department will move to enjoin the Contractor and any prime contractual affiliates, as in the case of a joint venture, from bidding as a prime Contractor, or participating as a subcontractor on VDOT projects until such submissions are received.

**(k) Documentation Required for Semi-final Payment**

On those projects nearing completion, the Contractor must submit Form C-63 marked "Semi-Final" within twenty (20) days after the submission of the last regular monthly progress estimate to the DCRO. The form must include each DBE used on the Contract work and the work performed by each DBE. The form shall include the actual dollar amount paid to each DBE for the accepted creditable work on the Contract. The form shall be certified under penalty of perjury, or other applicable law, to be accurate and complete. VDOT will use this certification and other information available to determine applicable DBE credit allowed to date by VDOT and the extent to which the DBEs were fully paid for that work. The Contractor shall acknowledge by the act of filing the form that the information is supplied to obtain payment regarding a federal participation contract. A letter of certification, signed by both the prime Contractor and appropriate DBEs, will accompany the form, indicating the amount, including any retainage, if present, that remains to be paid to the DBE(s).

**(l) Documentation Required for Final Payment**

On those projects that are complete, the Contractor shall submit a final Form C-63 marked "Final" to the DCRO, within thirty (30) days of the final estimate. The form must include each DBE used on the Contract and the work performed by each DBE. The form shall include the actual dollar amount paid to each DBE for the creditable work on the Contract. VDOT will use this form and other information available to determine if the Contractor and DBEs have satisfied the DBE contract goal percentage specified in the Contract and the extent to which credit was allowed. The Contractor shall acknowledge by the act of signing and filing the form that the information is supplied to obtain payment regarding a federal participation contract.

**(m) Prompt Payment Requirements**

The Contractor shall make prompt and full payment to the subcontractor(s) of any retainage held by the prime Contractor after the subcontractor's work is satisfactorily completed.

**ORDER NO.: 247**  
**CONTRACT ID. NO.: CM224PMF123441B**

For purposes of this Special Provision, a subcontractor's work is satisfactorily completed when all the tasks called for in the subcontract have been accomplished, documented, and accepted as required by the contract documents by VDOT. When VDOT has made partial acceptance of a portion of the prime contract, the Department will consider the work of any subcontractor covered by that partial acceptance to be satisfactorily completed. Payment will be made in accordance with the requirements of Section 107.01, Section 109.08, and Section 109.09 of the Specifications.

Upon VDOT's payment of the subcontractor's portion of the work as shown on the monthly progress estimate and the receipt of payment by the Contractor for such work, the Contractor shall make compensation in full to the subcontractor for that portion of the work satisfactorily completed and accepted by the Department. For the purposes of this Special Provision, payment of the subcontractor's portion of the work shall mean the Contractor has issued payment in full, less agreed upon retainage, if any, to the subcontractor for that portion of the subcontractor's work that VDOT paid to the Contractor on the monthly progress estimate.

The Contractor shall make payment of the subcontractor's portion of the work within seven (7) days of the receipt of payment from VDOT in accordance with the requirements of Section 107.01, Section 109.08, and Section 109.09 of the Specifications.

If the Contractor fails to make payment for the subcontractor's portion of the work within the time frame specified herein, the subcontractor shall contact the Responsible Engineer and the Contractor's bonding company in writing. The bonding company and VDOT will investigate the cause for non-payment and, barring mitigating circumstances that would make the subcontractor ineligible for payment, ensure payment in accordance with the requirements of Section 107.01, Section 109.08, and Section 109.09 of the Specifications.

By bidding on this contract, and by accepting and executing this contract, the Contractor agrees to assume these contractual obligations, and to bind the Contractor's subcontractors contractually to those prompt payment requirements.

Nothing contained herein shall preclude the Contractor from withholding payment to the subcontractor in accordance with the terms of the subcontract in order to protect the Contractor from loss or cost of damage due to a breach of agreement by the subcontractor.

**(n) Miscellaneous DBE Program Requirements**

1. **Loss of DBE Eligibility:** When a DBE firm has been removed from eligibility as a certified DBE firm, the following actions will be taken:
  - a. When a Bidder/Contractor has made a commitment to use a DBE firm that is not currently certified, thereby making the Contractor ineligible to receive DBE participation credit for work performed, and a subcontract has not been executed, the ineligible DBE firm does not count toward either the Contract goal or overall goal. The Contractor shall meet the Contract goal with a DBE firm that is eligible to receive DBE credit for work performed, or must demonstrate to the Contract Engineer that it has made good faith efforts to do so.
  - b. When a Bidder/Contractor has executed a subcontract with a certified DBE firm prior to official notification of the DBE firm's loss of eligibility, the Contractor may continue to use the firm on the Contract and shall continue to receive DBE credit toward its DBE goal for the subcontractor's work.
  - c. When VDOT has executed a prime contract with a DBE firm that is certified at the time of contract execution but that is later ruled ineligible, the portion of the ineligible firm's performance on the Contract before VDOT has issued the notice of its ineligibility shall count toward the Contract goal.

**ORDER NO.: 247**  
**CONTRACT ID. NO.: CM224PMF123441B**

2. **Termination of DBE:** If a certified DBE subcontractor is terminated, or fails, refuses, or is unable to complete the work on the Contract for any reason, the Contractor must promptly request approval to substitute or replace that firm in accordance with this section of this Special Provision.

The Contractor, as aforementioned in **DBE Program-Related Certifications Made by Bidders/Contractors**, shall notify VDOT in writing before terminating and/or replacing the DBE that was committed as a condition of contract award or that is otherwise being used or represented to fulfill DBE contract obligations during the Contract performance period. Written consent from the Department for terminating the performance of any DBE shall be granted only when the Contractor can demonstrate that the DBE is unable, unwilling, or ineligible to perform its obligations for which the Contractor sought credit toward the Contract DBE goal. Such written consent by the Department to terminate any DBE shall concurrently constitute written consent to substitute or replace the terminated DBE with another DBE. Consent to terminate a DBE shall not be based on the Contractor's ability to negotiate a more advantageous contract with another subcontractor whether that subcontractor is, or is not, a certified DBE.

- a. All Contractor requests to terminate, substitute, or replace a certified DBE shall be in writing, and shall include the following information:
- (1) The date the Contractor determined the DBE to be unwilling, unable, or ineligible to perform.
  - (2) The projected date that the Contractor shall require a substitution or replacement DBE to commence work if consent is granted to the request.
  - (3) A brief statement of facts describing and citing specific actions or inaction by the DBE giving rise to the Contractor's assertion that the DBE is unwilling, unable, or ineligible to perform;
  - (4) A brief statement of the affected DBE's capacity and ability to perform the work as determined by the Contractor;
  - (5) A brief statement of facts regarding actions taken by the Contractor which are believed to constitute good faith efforts toward enabling the DBE to perform;
  - (6) The current percentage of work completed on each bid item by the DBE;
  - (7) The total dollar amount currently paid per bid item for work performed by the DBE;
  - (8) The total dollar amount per bid item remaining to be paid to the DBE for work completed, but for which the DBE has not received payment, and with which the Contractor has no dispute;
  - (9) The total dollar amount per bid item remaining to be paid to the DBE for work completed, but for which the DBE has not received payment, and over which the Contractor and/or the DBE have a dispute.
- b. Contractor's Written Notice to DBE of Pending Request to Terminate and Substitute with another DBE.

The Contractor shall send a copy of the "request to terminate and substitute" letter to the affected committed DBE firm, in conjunction with submitting the request to the DCRO. The affected DBE firm may submit a response letter to the Department within two (2) business days of receiving the notice to terminate from the Contractor. The affected DBE firm shall

**ORDER NO.: 247**  
**CONTRACT ID. NO.: CM224PMF123441B**

explain its position concerning performance on the committed work. The Department will consider both the Contractor's request and the DBE's response and explanation before approving the Contractor's termination and substitution request, or determining if any action should be taken against the Contractor.

If, after making its best efforts to deliver a copy of the "request to terminate and substitute" letter, the Contractor is unsuccessful in notifying the affected DBE firm, the Department will verify that the affected, committed DBE firm is unable or unwilling to continue the Contract. The Department will immediately approve the Contractor's request for a substitution.

c. **Proposed Substitution of Another Certified DBE**

Upon termination of a DBE, the Contractor shall use reasonable good faith efforts to replace the terminated DBE. The termination of such DBE shall not relieve the Contractor of its obligations pursuant to this section, and the unpaid portion of the terminated DBE's contract will not be counted toward the Contract goal.

When a DBE substitution is necessary, the Contractor shall submit an amended Form C-111 with the name of another DBE firm, the proposed work to be performed by that firm, and the dollar amount of the work to replace the unfulfilled portion of the work of the originally committed DBE firm. The Contractor shall furnish all pertinent information including the Contract I.D. number, project number, bid item, item description, bid unit and bid quantity, unit price, and total price. In addition, the Contractor shall submit documentation for the requested substitute DBE as described in this section of this Special Provision.

Should the Contractor be unable to commit the remaining required dollar value to the substitute DBE, the Contractor shall provide written evidence of good faith efforts made to obtain the substitute value requirement. The Department will review the quality, thoroughness, and intensity of those efforts. Efforts that are viewed by VDOT as merely superficial or pro-forma will not be considered good faith efforts to meet the Contract goal for DBE participation. The Contractor must document the steps taken that demonstrated its good faith efforts to obtain participation as set forth in the **Good Faith Efforts Described** section of this Special Provision.

**3. Factors Used to determine if a DBE Trucking Firm is performing a CUF:**

The following factors will be used to determine whether a DBE trucking company is performing a CUF:

- a. To perform a CUF the DBE trucking firm shall be completely responsible for the management and supervision of the entire trucking operation for which the DBE is responsible by subcontract on a particular contract. There shall not be a contrived arrangement, including, but not limited to, any arrangement that would not customarily and legally exist under regular construction project subcontracting practices for the purpose of meeting the DBE contract goal;
- b. The DBE must own and operate at least one fully licensed, insured, and operational truck used in the performance of the Contract work. This does not include a supervisor's pickup truck or a similar vehicle that is not suitable for and customarily used in hauling the necessary materials or supplies;
- c. The DBE receives full contract goal credit for the total reasonable amount the DBE is paid for the transportation services provided on the Contract using trucks the DBE owns, insures, and operates using drivers that the DBE employs and manages;



**ORDER NO.: 247**  
**CONTRACT ID. NO.: CM224PMF123441B**

- d. The DBE may lease trucks from another certified DBE firm, including from an owner-operator who is certified as a DBE. The DBE firm that leases trucks from another DBE will receive credit for the total fair market value actually paid for transportation services the lessee DBE firm provides on the Contract;
- e. The DBE may also lease trucks from a non-DBE firm, including an owner-operator. The DBE who leases trucks from a non-DBE is entitled to credit for the total value of the transportation services provided by non-DBE lessees, *not to exceed the value of transportation services provided by DBE-owned trucks on the Contract*. For additional participation by non-DBE lessees, the DBE will only receive credit for the fee or commission it receives as a result of the lease arrangement.

*EXAMPLE*

DBE Firm X uses two (2) of its own trucks on a contract. The firm leases two (2) trucks from DBE Firm Y and six (6) trucks from non-DBE Firm Z.

<u><b>Firm X</b></u>		<b>Value of Trans. Serv.</b>
Truck 1	Owned by DBE	\$100 per day
Truck 2	Owned by DBE	\$100 per day
<u><b>Firm Y</b></u>		
Truck 1	Leased from DBE	\$110 per day
Truck 2	Leased from DBE	\$110 per day
<u><b>Firm Z</b></u>		
Truck 1	Leased from Non DBE	\$125 per day
Truck 2	Leased from Non DBE	\$125 per day
Truck 3	Leased from Non DBE	\$125 per day
Truck 4	Leased from Non DBE	\$125 per day
Truck 5	Leased from Non DBE*	\$125 per day
Truck 6	Leased from Non DBE*	\$125 per day

DBE credit would be awarded for the total transportation services provided by DBE Firm X and DBE Firm Y, and may also be awarded for the total value of transportation services by four (4) of the six (6) trucks provided by non-DBE Firm Z (not to exceed the value of transportation services provided by DBE-owned trucks).

**Credit = 8 Trucks**  
**Total Value of Transportation Services = \$820**

**ORDER NO.: 247**  
**CONTRACT ID. NO.: CM224PMF123441B**

In all, full DBE credit would be allowed for the participation of eight (8) trucks (twice the number of DBE trucks owned and leased) and the dollar value attributable to the Value of Transportation Services provided by the 8 trucks.

\* With respect to the other two trucks provided by non-DBE Firm Z, DBE credit could be awarded only for the fees or commissions pertaining to those trucks that DBE Firm X receives as a result of the lease with non-DBE Firm Z.

- f. For purposes of this section, the lease must indicate that the DBE firm leasing the truck has exclusive use of and control over the truck. This will not preclude the leased truck from working for others during the term of the lease with the consent of the DBE, provided the lease gives the DBE absolute priority for and control over the use of the leased truck. Leased trucks must display the name and identification number of the DBE firm that has leased the truck at all times during the life of the lease.
4. **Data Collection:** In accordance with 49CFR Section 26.11, all firms bidding on prime contracts and bidding or quoting subcontracts on federal-aid projects shall provide the following information to the Contract Engineer annually.
- Firm name
  - Firm address
  - Firm's status as a DBE or non-DBE
  - The age of the firm and
  - The annual gross receipts of the firm

The means of transmittal and the risk for timely receipt of this information shall be the responsibility of the bidder. However, the above information can be submitted by means of the Annual Gross Receipts Survey as required in the Prequalification/Certification application.

All bidders, including DBE prime Contractor bidders, shall complete and submit to the Contract Engineer the Subcontractor/Supplier Solicitation and Utilization Form C-48 for each bid submitted; to be received within ten (10) business days after the bid opening. Failure of bidders to submit this form in the time frame specified may be cause for disqualification of the bidder and rejection of their bid in accordance with the requirements of this Special Provision, the Contract specifications, and VDOT Road and Bridge specifications.

**(o) Suspect Evidence of Criminal Behavior**

Failure of a bidder, Contractor, or subcontractor to comply with the Virginia Department of Transportation Road and Bridge Specifications and these Special Provisions wherein there appears to be evidence of criminal conduct shall be referred to the Attorney General for the Commonwealth of Virginia and/or the FHWA Inspector General for criminal investigation and, if warranted, prosecution.

**Suspected DBE Fraud**

In appropriate cases, VDOT will bring to the attention of the U. S. Department of Transportation (USDOT) any appearance of false, fraudulent, or dishonest conduct in connection with the DBE program, so that USDOT can take the steps, e.g., referral to the Department of Justice for criminal prosecution, referral to the USDOT Inspector General, action under suspension and debarment or Program Fraud and Civil Penalties rules provided in 49CFR Part 31.

**(p) Summary of Remedies for Non-Compliance with DBE Program Requirements**

**ORDER NO.: 247**  
**CONTRACT ID. NO.: CM224PMF123441B**

Failure of any bidder\Contractor to comply with the requirements of this Special Provision for Section 107.15 of the Virginia Road and Bridge Specifications, which is deemed to be a condition of bidding, or where a contract exists, is deemed to constitute a breach of contract shall be remedied in accordance with the following:

**1. Disadvantaged Business Enterprise (DBE) Program Requirements**

The Contractor shall carry out applicable requirements of 49 CFR Part 26 in the award, administration, and performance of this contract. Failure by the Contractor to carry out these requirements is a material breach of this contract, which will result in the termination of this contract or other such remedy, as VDOT deems appropriate.

All administrative remedies noted in this provision are automatic unless the Contractor exercises the right of appeal within the required timeframe(s) specified herein.

**2. DBE Program-Related Certifications Made by Bidders\Contractors**

Once awarded the contract, the Contractor shall comply fully with all regulatory and contractual requirements of the USDOT DBE Program, and that each certified DBE firm participating in the Contract shall fully perform the designated work items with the DBE's own forces and equipment under the DBE's direct supervision, control, and management. Where a contract exists and where the Contractor, DBE firm, or any other firm retained by the Contractor has failed to comply with federal or VDOT DBE Program regulations and/or their requirements on that contract, VDOT has the authority and discretion to determine the extent to which the DBE contract requirements have not been met, and will assess against the Contractor any remedies available at law or provided in the Contract in the event of such a contract breach.

**3. Disqualification of Bidder**

Bidders may be disqualified from bidding for failure to comply with the requirements of this Special Provision, the Contract specifications, and VDOT Road and Bridge Specifications.

**4. Bidding Procedures**

The failure of a bidder to submit the required documentation within the timeframes specified in the **Contract Goal, Good Faith Efforts Specified** section of this Special Provision may be cause for rejection of that bidder's bid. If the lowest bidder is rejected for failure to submit required documentation in the specified time frames, the Department may either award the work to the next lowest bidder, or re-advertise and construct the work under contract or otherwise as determined by the Commonwealth.

In order to award a contract to a bidder that has failed to meet DBE contract goal requirements, VDOT will determine if the bidder's efforts were adequate good faith efforts, and if given all relevant circumstances, those efforts were to the extent a bidder actively and aggressively seeking to meet the requirements would make. Regardless of the DBE contract goal participation level proposed by the bidder or the extent of good faith efforts shown, all bidders shall timely and separately file their completed and executed Forms C-111, C-112, C-48, and Form C-49, as aforementioned, or face potential bid rejection. If a bidder does not submit it's completed and executed C-111, or C-112, when required by this Special Provision, the bidder's bid will be considered non-responsive and may be rejected. If, after reconsideration, the Department determines the bidder has failed to meet the requirements of the Contract goal and has failed to make adequate good faith efforts to achieve the level of DBE participation as specified in the bid proposal, the bidder's bid will be rejected. If sufficient documented evidence is presented to demonstrate that the apparent low bidder made reasonable good faith efforts,

**ORDER NO.: 247**  
**CONTRACT ID. NO.: CM224PMF123441B**

the Department will award the Contract and reduce the DBE requirement to the actual commitment identified by the lowest successful bidder at the time of its bid. The Contractor is encouraged to seek additional participation during the life of the Contract.

If the Contractor fails to conform to the schedule of DBE participation as shown on the progress schedule, or at any point at which it is clearly evident that the remaining dollar value of allowable credit for performing work is insufficient to obtain the scheduled participation, the Contractor and any aforementioned affiliates may be enjoined from bidding for 60 days or until such time as conformance with the schedule of DBE participation is achieved. In such instances, the Contractor is expected to seek DBE participation towards meeting the goal during the prosecution of the Contract.

If the Contractor fails upon completion of the project to meet the required participation, the Contractor and any prime contractual affiliates, as in the case of a joint venture, may be enjoined from bidding as a prime Contractor, or participating as a subcontractor on VDOT projects for a period of 90 days.

Prior to enjoinder from bidding or denial to participate as a subcontractor for failure to comply with participation requirements, as provided hereinbefore, the Contractor may submit documentation to the State Construction Engineer to substantiate that failure was due solely to quantitative underrun(s) or elimination of items subcontracted to DBEs, and that all feasible means have been used to obtain the required participation. The State Construction Engineer upon verification of such documentation shall make a determination whether or not the Contractor has met the requirements of the Contract.

If it is determined that the aforementioned documentation is insufficient or the failure to meet required participation is due to other reasons, the Contractor may request an appearance before the Administrative Reconsideration Panel to establish that all feasible means were used to meet such participation requirements. The decision of the Administrative Reconsideration Panel shall be administratively final. The enjoinder period will begin upon the Contractor's failure to request a hearing within the designated time frame or upon the Administrative Reconsideration Panel's decision to enjoin, as applicable.

**5. Verification of DBE Participation and Imposed Damages**

If the Contractor fails to comply with correctly completing and submitting any of the required documentation requested by this provision within the specified time frames, the Department will withhold payment of the monthly progress estimate until such time as the required submissions are received by VDOT. Where such failures to provide required submittals or documentation are repeated the Department will move to enjoin the Contractor and any prime contractual affiliates, as in the case of a joint venture, from bidding as a prime Contractor, or participating as a subcontractor on VDOT projects until such submissions are received.

**(q) Suspect Evidence of Criminal Behavior**

In addition to the remedies described heretofore in this provision VDOT also exercises its rights with respect to the following remedies:

- Failure of a bidder, Contractor, or subcontractor to comply with the Virginia Department of Transportation Road and Bridge Specifications and these Special Provisions wherein there appears to be evidence of criminal conduct shall be referred to the Attorney General for the Commonwealth of Virginia and/or the FHWA Inspector General for criminal investigation and, if warranted prosecution.

**ORDER NO.: 247**  
**CONTRACT ID. NO.: CM224PMF123441B**

- In appropriate cases, VDOT will bring to the attention of the U. S. Department of Transportation (USDOT) any appearance of false, fraudulent, or dishonest conduct in connection with the DBE program, so that USDOT can take the steps, e.g., referral to the Department of Justice for criminal prosecution, referral to the USDOT Inspector General, action under suspension and debarment or Program Fraud and Civil Penalties rules provided in 49CFR Part 31.

**ORDER NO.: 247**  
**CONTRACT ID. NO.: CM224PMF123441B**

**SP109-000100-04**

VIRGINIA DEPARTMENT OF TRANSPORTATION  
SPECIAL PROVISION FOR  
**ASPHALT MATERIAL PRICE ADJUSTMENT**

June 29, 2023

All asphalt material contained in the master listing on the [Construction Division web site](#) of eligible bid items and designated by pay items in the Contract will be price adjusted according to the provisions as set forth herein. Other items will not be adjusted, except as otherwise specified in the Contract. If new pay items which contain asphalt material are established by Change Order, they will not be subject to Price Adjustment unless specifically designated in the Change Order to be subject to Price Adjustment.

Each month, the Department will publish an average state-wide PG 64S-22 f.o.b. price per ton and an average PG 64E-22 f.o.b. price per ton developed from the average terminal prices provided to the Department from suppliers of asphalt cement to contractors doing work in Virginia. The Department will collect terminal prices from approximately 12 terminals each month. These prices will be received once each month from suppliers on or about the last weekday of the month. The high and low prices will be eliminated and the remaining values averaged to establish the average statewide price for the following month. The monthly state-wide average price will be posted on the Construction Division website on or about the first weekday of the following month. In the event the average prices were to change by 10 percent or more of the Base Index during the middle of the month the Contractor can submit a letter to the Department and supplier that provides evidence of the difference in price. Upon receipt of the letter consideration will be given to extend additional adjustments as deemed necessary.

This monthly statewide average price will be the Base Index for all contracts on which bids are received during the calendar month of its posting and will be the Current Index for all asphalt placed during the calendar month of its posting. In the event an index changes radically from the apparent trend, as determined by the Engineer, the Department may establish an index which it determines to best reflect the trend.

The amount of adjustment applied will be based on the difference between the contract Base Index and the Current Index for the applicable calendar month during which the work is performed. The quantity of asphalt cement for asphalt concrete pavement to which adjustment will be applied will be the quantity based on the percent of asphalt cement shown on the appropriate approved job mix formula.

Adjustment of any asphalt material other than PG 64S-22 and PG 64E-22 will be based on the indexes for PG 64S-22.

The quantity of asphalt emulsions to which adjustment will be applied will be the quantity based on 65 percent residual asphalt.

Price adjustment will be shown as a separate entry on the monthly progress estimate; however, such adjustment will not be included in the total cost of the work for progress determination or for extension of contract time. Price adjustment will be calculated using the same units as the corresponding Pay Items in the Contract.

Any apparent attempt to unbalance bids in favor of items subject to price adjustment or failure to submit required cost and price data as noted hereinbefore may result in rejection of the bid proposal.

**ORDER NO.: 247**  
**CONTRACT ID. NO.: CM224PMF123441B**

[SP109-000110-00](#)

VIRGINIA DEPARTMENT OF TRANSPORTATION  
SPECIAL PROVISION FOR  
**OPTIONAL ADJUSTMENT FOR FUEL**

July 1, 2015; Reissued July 12, 2016

The Department will adjust monthly progress payments up or down as appropriate for cost changes in fuel used on specific items of work identified in this provision. The Department will provide a master listing of standard bid items eligible for fuel adjustment on its website.

Included with this proposal is a listing of standard bid items the Department has identified as eligible for fuel adjustment on this project(s) as well as the respective fuel factors per pay unit for those items. Only items on this listing will be eligible for adjustment. The fuel usage factor for each item is considered inclusive of all fuel usage. Generally, non-standard pay items are not eligible for fuel adjustment.

The listing of eligible items applicable to this particular project is shown on Form C-21B "Bid Items Eligible for Fuel Adjustment" included with the bidding documents. The Bidder may choose to have fuel adjustment applied to any or all eligible items on this project's listing by designating the items for which the fuel adjustment will apply. The Bidder's selection of items for fuel adjustment may not be changed once he has submitted Form C-21B to the Department.

In order to be eligible for fuel adjustment under this provision, the apparent lowest responsive and responsible Bidder shall clearly identify on Form C-21B those pay items he chooses to have fuel adjustment applied on. Within 21 days after the receipt of bids the apparent successful Bidder shall submit his designated items on Form C-21B to the Contract Engineer. Items the successful Bidder chooses for fuel adjustment must be designated by writing the word "Yes" in the column titled "Option" by each bid item chosen for fuel adjustment. The successful Bidder's designations on Form C-21B must be written in ink or typed, and signed by this Bidder to be considered complete. Items not properly designated or left blank on the Bidder's C-21B "Bid Items Eligible for Fuel Adjustment" form may be not considered for adjustment. If the apparent successful Bidder fails to return his Form C-21B within the timeframe specified, items will not be eligible for fuel adjustment on this project.

The monthly index price to be used in the administration of this provision will be calculated by the Department from the Diesel fuel prices published by the U. S. Department of Energy, Energy Information Administration on highway diesel prices, for the Lower Atlantic region. The monthly index price will be the price for diesel fuel calculated by averaging each of the weekly posted prices for that particular month.

For the purposes of this provision, the base index price will be calculated using the data from the month preceding the receipt of bids. The base index price will be posted by the Department at the beginning of the month for all bids received during that month.

The current index price will be posted by the Department and will be calculated using the data from the month preceding the particular estimate being vouchered for payment.

The current monthly quantity for eligible items of work selected by the Contractor for fuel adjustment will be multiplied by the appropriate fuel factor to determine the gallons of fuel to be cost adjusted. The amount of adjustment per gallon will be the net difference between the current index price and the base index price. Computation for adjustment will be made as follows:

**ORDER NO.: 247**  
**CONTRACT ID. NO.: CM224PMF123441B**

$$S = (E - B) QF$$

Where; S = Monetary amount of the adjustment (plus or minus)  
B = Base index price  
E = Current index price  
Q = Quantity of individual units of work  
F = Appropriate fuel factor

Adjustments will not be made for work performed beyond the original contract time limit unless the original time limit has been changed by an executed Work Order.

If new pay items are added to this contract by Work Order and they are listed on Department's master listing of eligible items, the Work Order must indicate which of these individual items will be fuel adjusted; otherwise, those items will not be fuel adjusted. If applicable, designating which new pay items will be added for fuel adjustment must be determined during development of the Work Order and clearly shown on Form C-10 Work Order. The Base Index price on any new eligible pay items added by Work Order will be the Base Index price posted for the month in which bids were received for that particular project. The Current Index price for any new eligible pay items added by Work Order will be the Index price posted for the month preceding the estimate on which the Work Order is paid.

When quantities differ between the last monthly estimate prepared upon final acceptance and the final estimate, adjustment will be made using the appropriate current index for the period in which that specific item of work was last performed.

In the event any of the base fuel prices in this contract increase more than 100 percent (i.e. fuel prices double), the Engineer will review each affected item of work and give the Contractor written notice if work is to stop on any affected item of work. The Department reserves the right to reduce, eliminate or renegotiate the unit price for remaining portions of affected items of work.

Any amounts resulting from fuel adjustment will not be included in the total cost of work for determination of progress or for extension of contract time.



**ORDER NO.: 247**  
**CONTRACT ID. NO.: CM224PMF123441B**

**SP109-000130-00**

VIRGINIA DEPARTMENT OF TRANSPORTATION  
SPECIAL PROVISION FOR  
**USE OF ELECTRONICALLY TRANSMITTED WEIGH TICKETS**

October 10, 2019

**SECTION 109 – MEASUREMENT AND PAYMENT** of the Specifications is amended as follows:

**Section 109.01(b) Measurement by Weight** is replaced with the following:

**Measurement by Weight:** Materials that are measured or proportioned by weight shall be weighted on accurate scales as specified in this Section. When material is paid for on a tonnage basis, personnel performing the weighing shall be certified by the Department and shall be bonded to the Commonwealth of Virginia in the amount of \$10,000 for the faithful observance and performance of the duties of the weighperson required herein. The bond shall be executed on a form having the exact wording as the Weighpersons Surety Bond Form furnished by the Department and shall be submitted to the Department prior to the furnishing of the tonnage material.

Trucks used to haul material shall be equipped with a cover suitable to protect the material and to protect the traveling public. The truck tare to be used in the weighing operation shall be the weight of the empty truck determined with full tanks of fuel and the operator seated in the cab. The tare weight of trucks shall be recorded to the nearest 20 pounds. At the option of the Contractor, a new tare may be determined for each load. When a new tare is obtained for each load, the requirement for full tanks of fuel will be waived.

Net rail shipment weights may be used for pay quantities when evidenced by railroad bills of lading. However, such weights will not be accepted for pay quantities of materials that subsequently pass through a stationary mixing plant.

Scales shall conform to the requirements for accuracy and sensitivity as set forth in the NIST Handbook No. 44 for Specification Tolerances and Requirements for Commercial and Weighing Devices. Scales used in the weighing of materials paid for on a tonnage basis shall be approved and sealed in accordance with the requirements of the policies of the Bureau of Weights and Measures of the Department of Agriculture and Consumer Services, or other approved agencies, at least once every six months and upon being moved. Hopper and truck scales shall be serviced and tested by a scale service representative at least once every six months. Hopper scales shall be checked with a minimum 500 pounds of test weights and truck scales shall be checked with a minimum 20,000 pounds of test weights.

Copies of scale test reports shall be maintained on file at the scale location for at least 18 months, and copies of all scale service representative test reports shall be forwarded to the Department.

The quantity of materials paid for on a tonnage basis shall be determined on scales equipped with an automatic printer. Truck scale printers shall print the net weight and either the gross or tare weight of each load. Hopper scale printers shall print the net weight of each load. The weigh ticket shall also show the legal gross weight for material weighed on truck scales and the legal net weight for material weighed on hopper scales. As a substitute for printed tickets, electronic tickets may be provided. Electronic ticketing systems shall record and show all the same information required on a printed ticket and meet the requirements herein.

**ORDER NO.: 247**  
**CONTRACT ID. NO.: CM224PMF123441B**

If the automatic printer becomes inoperative, the weighing operation may continue for 48 hours provided satisfactory visual verification of weights can be made. The written permission of the District Materials Engineer shall be required for the operation of scales after 48 hours.

If significant discrepancies are discovered in the printed or electronically recorded and displayed weight, the ultimate weight for payment will be calculated on volume measurements of the materials in place and unit weights determined by the Engineer or by other methods deemed appropriate to protect the interests of the Commonwealth.

1. **Duties of the Weighperson.** The weighperson shall furnish a signed weigh ticket or electronic ticket for each load that shows the date, load number, plant name, size and type of material, project number, schedule or purchase order number, and the weights specified herein; maintain sufficient documentation so that the accumulative tonnage and distribution of each lot of material, by Contract, can be readily identified; and submit by the end of the next working day a summary of the number of loads and total weights for each type of material by Contract.
2. **Electronic ticketing system.** Electronic tickets may be provided as a substitute for weigh tickets at no additional cost to the Department. Electronic Tickets shall be automatically generated using a combined software and hardware fleet management or electronic ticketing system. This system shall be fully integrated with the Contractor's Load Read-Out scale system used to weigh the material being placed.

The system must be accessible to all engineering and inspection staff involved in the project via a mobile device (iOS or android) and a desktop computer.

In addition to the information required for printed weigh tickets, the system must provide the following information to the Engineer at any point in time during or after materials placement:

- Description of material being transported
- Mix Design Number or VDOT Material Identifier
- Unique Truck ID
- Time at Scale
- Time at Destination
- Time offloaded from vehicle
- Location (latitude and longitude in decimal degrees to nearest 0.0000001) where material was offloaded from truck.

If the supplier chooses to utilize the electronic ticket option, the system must allow individual tickets and daily summaries to be exported as Portable Document Format (PDF) files conforming to ISO 32000.

The system software and hardware shall be designed in such a way that data inputs from scales cannot be altered by the Contractor or the Department.

Delays due to poor GPS satellite reception, loss of cellular coverage, or any other technical or mechanical issues with an electronic ticketing system software, hardware, or other components will not be considered entitlement to any form of adjustment or time extension. The Engineer may reject material at any time if electronic tickets become unavailable or fail to provide appropriate and correctly formatted information at the time the ticket is transmitted. The Contractor, at his discretion, may provide printed tickets in place of electronic tickets, provided they comply with the requirements herein.

**ORDER NO.: 247**  
**CONTRACT ID. NO.: CM224PMF123441B**

[SP208-000100-00](#)

VIRGINIA DEPARTMENT OF TRANSPORTATION  
SPECIAL PROVISION FOR  
**SECTION 208—SUBBASE AND AGGREGATE BASE MATERIAL**  
**Crushed Hydraulic Cement Concrete (CHCC)**

July 12, 2016

**SECTION 208—SUBBASE AND AGGREGATE BASE MATERIAL** of the Specifications is amended as follows:

**Section 208.02—Materials** is replaced with the following:

(a) **Subbase material** may consist of any mixture of natural or crushed gravel, crushed stone or slag, **crushed hydraulic cement concrete (CHCC)**, and natural or crushed sand; with or without soil mortar. Subbase material may be used in a stabilized or unstabilized form.

(b) **Aggregate base material** may be designated as Type I or Type II as follows:

**Type I** shall consist of crushed stone, crushed slag, crushed hydraulic cement concrete (CHCC), crushed gravel or any combination of these material: with or without soil mortar or other admixtures. Crushed gravel shall consist of particles of which at least 90 percent by weight of the material retained on the No. 10 sieve shall have at least one face fractured by artificial crushing.

**Type II** shall consist of gravel, stone, or slag screenings; fine aggregate and crushed coarse aggregate; sand-clay-gravel mixtures; crushed hydraulic cement concrete; or any combination of these materials; with or without soil mortar or other admixtures. Aggregate base materials Type I or II may be used in a stabilized or unstabilized form.

(c) **Crushed Hydraulic Cement Concrete** shall not be used as Subbase or aggregate base material when any subsurface drainage system, such as standard underdrains (UD-4 or UD-5) and /or a stabilized open graded aggregate drainage layer (OGDL) is present, except when the CHCC is cement stabilized.

**Section 208.03(b) Atterberg Limits** is amended to include the following:

**Plasticity:** Subbase and aggregate base materials shall be either non-plastic (PI=0) or shall conform to Table II-11 of the Specifications when tested according to VTM-7. If the material is classified as non-plastic (PI=0), according to VTM-7, the Liquid Limit requirement will be waived. Exceptions to this provision are noted as follows:

1. 100% CHCC and 20% or less CHCC Blends will be tested and subject to penalty as noted in Table II-11 of the Specifications for the plasticity index, excluding Liquid Limit penalties.
2. Greater than 20% CHCC Blends will follow testing guidelines as set forth in Section 208.06 (b) for Atterburg limits.

**Section 208.03** is amended to add the following:

(h) **Deleterious Material:** The quantity of deleterious materials present in stockpiles of Crushed Hydraulic Cement Concrete, to be used in blending with virgin aggregates or as 100 percent CHCC, shall not exceed the following values:

**ORDER NO.: 247**  
**CONTRACT ID. NO.: CM224PMF123441B**

<b>MATERIAL</b>	<b>PERCENT BY WEIGHT (MASS)</b>
Asphalt Concrete	5.0
Glass and Metals	5.0
Wood, Plastic, Brick and other foreign matter	0.5

**Section 208.04—Job-Mix Formula** is replaced by the following:

- (a) The Contractor shall submit, or shall have the source of supply submit, for the Engineer's approval, a job-mix formula for each mixture to be supplied for the project prior to starting work. The formula shall be within the design range specified in Table II-9 of the Specifications. If unsatisfactory results or other conditions make it necessary, the Contractor shall prepare and submit a new job-mix formula for approval.
- (b) A job mix formula shall be submitted for the engineer's approval for each category of CHCC mixture used. Designated categories shall indicate the mixture percentage of CHCC used according to the following criteria:
  1. **Category 1:** 100% CHCC  
**Category 2:** 20% or less CHCC (□ 20%)  
**Category 3:** greater than 20% CHCC but less than 100% CHCC (>20%<100%)
  2. The quantity of CHCC in the mix shall be expressed as a percentage of the total mix.

**Section 208.06—Acceptance** is amended to include the following:

The following applies specifically to the use of Crushed Hydraulic Cement Concrete (CHCC) mixtures in addition to the acceptance criteria specified in this section:

1. **100% CHCC** shall conform to this special provision.
2. **20% or Less CHCC Blends** shall conform to this special provision.
3. **Greater than 20% CHCC Blends** shall conform to the following:
  - a. The virgin aggregate portion of the blend will be tested for Atterberg limits, prior to CHCC blending.
  - b. Price adjustments for Liquid Limit and the Plasticity Index of the virgin aggregates used in the blend with CHCC shall be according to Table II-11 of the Specifications.
  - c. No additional testing for Liquid Limit or Plasticity Index will be required on the final blended product.
4. All shipments of products containing CHCC must be designated on the shipping ticket (scale ticket) by the use of the letter "R". Examples: [22R, 21AR and 21BR] for: Aggregate Base material, Type I or Subbase materials.

**ORDER NO.: 247**  
**CONTRACT ID. NO.: CM224PMF123441B**

[SP211-000100-02](#)

VIRGINIA DEPARTMENT OF TRANSPORTATION  
SPECIAL PROVISION FOR  
**SECTION 211—ASPHALT CONCRETE**

March 28, 2022

**SECTION 211—ASPHALT CONCRETE** of the Specifications is amended as follows:

**Section 211.03(a) SUPERPAVE mixes** is amended by inserting the following:

For SM-9.5 and SM-12.5 mixes, the minimum asphalt contents shall be based on the following unless otherwise approved by the Engineer:

<b>Bulk Specific Gravity of the Total Aggregate</b>	<b>Minimum Design AC Content Mix Type (%)</b>	
	<b>SM-9.5</b>	<b>SM-12.5</b>
Less Than 2.65	5.5	5.3
2.65 - 2.74	5.4	5.2
2.74 - 2.85	5.3	5.1
Greater Than 2.85	5.2	5.0

**Section 211.09—Adjustment System** is amended to replace the third paragraph with the following:

If the total adjustment for a lot is greater than 25 points, the Contractor shall remove the failing material from the road. If the total adjustment is 25 points or less and the Contractor does not elect to remove and replace the material, the unit price for the material will be reduced by 3% for SM, IM, and BM Superpave mixes, and by 1% for all other mixes, for each adjustment point the material is outside of the process tolerance. The Engineer will apply this adjustment to the tonnage represented by the samples. If the Engineer applies adjustment points against two successive lots, the Contractor shall ensure plant adjustment is made prior to continuing production.

**Section 211.09—Adjustment System** is amended to replace the last paragraph with the following:

The Engineer will reduce the unit bid price for SM, IM, and BM Superpave mixes by 1.0%, and for all other mixes by 0.5%, for each adjustment point applied for standard deviation.

The Engineer will increase the unit bid price for SM, IM, and BM mixes by 5% if the following criteria are met: 1) the standard deviation of the AC content is within the ranges of 0.0 – 0.15; 2) there are no adjustment points assigned for any sieve sizes as noted in Table II-16; and 3) the average AC content is no less than 0.10% below and no more than 0.20% above the approved mix design AC content.

**ORDER NO.: 247**  
**CONTRACT ID. NO.: CM224PMF123441B**

[SP305-000100-01](#)

VIRGINIA DEPARTMENT OF TRANSPORTATION  
SPECIAL PROVISION FOR  
**SHOULDER RENOVATION**

October 3, 2016

**I. DESCRIPTION**

This work shall consist of renovating existing low (erosion or overlay) and high shoulders (debris buildup) and shoulders disturbed due to plant mix overlay or guardrail work as specified in the Contract Documents to provide finished shoulder designs and guardrail heights that conform to the Specifications, Standard Drawings, and Plans. For the purposes of this provision, machining shoulders and manual shoulder restoration shall be viewed as placing, grading, and compacting operations of approved shoulder materials performed by mechanized equipment or manually. Materials allowed for renovating shoulders shall include furnishing and delivery of these materials to the jobsite or to the location(s) designated in the Contract Documents.

**II. MATERIALS**

Shoulder material shall be either virgin aggregate base material (type and size as specified) or Shoulder Maintenance Material (SMM). SMM shall be: Aggregate Material; Crusher Run Aggregate; Aggregate Subbase or Base; Select Material; recycled materials including Reclaimed Asphalt Pavement (RAP) or Crushed Hydraulic *Cement* Concrete (CHCC); or combinations thereof, conforming to the followings grading when tested in accordance with VTM-25:

<b>% by Weight of Material Passing Sieve</b>		
<b>1-1/2 in</b>	<b>1 in</b>	<b>No. 4</b>
100	80-100	20-60

Shoulder Maintenance Material, if used, shall be 1-1/2 inch maximum size as determined visually, using VTM-25, or by field measurement. Shoulder Maintenance Material shall have a loose, unconsolidated consistency and shall not contain any clusters of materials that exceed the 1-1/2-inch grading requirement. Material out of conformance with the maximum size limitation will be rejected. However, a sample of material shall be tested for gradation using VTM-25; test results within the last year may be used for stockpile material.

Shoulder Maintenance Material, when comprised of blended aggregate, RAP, or CHCC, shall be thoroughly mixed (manipulated) and shall have a dappled appearance when placed, graded, and compacted.

The use of Shoulder Maintenance Material is subject to the limitations as described herein and elsewhere in the Special Provision Copied Note for Alternate Category Bid Items and Award of Contract included in the Contract.

**III. PROCEDURES**

The use of more than one type of approved material on uninterrupted runs of shoulder work will not be permitted.

The use of CHCC or any CHCC blended material as SMM will only be permitted in areas 3 feet in width or less and no more than 3 inches in compacted depth once placed.

**ORDER NO.: 247**  
**CONTRACT ID. NO.: CM224PMF123441B**

Shoulder material shall be spread, graded, and compacted according to Section 305.03(e) of the Specifications, except as noted herein. Subgrade shaping will generally not be required unless directed by the Engineer. However, when shaping of the subgrade is required, the cost of such work shall be included in the cost of machining shoulders or manual shoulder renovation work.

The maximum compacted lift thickness of shoulder material (except CHCC or CHCC blends) shall be 6 inches. The acceptability of furnished and finished (compact) shoulder material will be determined by visual inspection, field measurement, or a combination thereof, at the discretion of the Engineer.

Final pavement surface edge or final paved or stabilized shoulder surface edge shall include existing pavement not designated for overlay and completely compacted pavement overlays, and their corresponding shoulders.

The Contractor shall promptly remove and dispose of surplus shoulder material encountered as a result of shoulder renovation work as well as any shoulder material spilled, left or tracked on the pavement.

Grading for shoulder renovation shall be performed by the following methods:

**A. Machining shoulders** shall be performed in areas where there is no existing guardrail and none is scheduled to be placed or updated under this contract, in areas with existing guardrail where that guardrail will not be disturbed, in areas scheduled for new guardrail installation before new guardrail is installed, or in areas where existing guardrail will be removed in preparation for guardrail improvement or guardrail replacement. In each of these grading situations it is to be assumed grading can be performed by mechanized equipment unencumbered by existing or newly installed guardrail.

Machining shoulders shall include grading shoulders to appropriate slope and grade where sufficient material is present to renovate the existing shoulders, grading existing shoulders to fill in low areas after shoulder material has been placed, or grading down areas where high shoulders exist due to debris buildup.

Machining shoulders shall result in a uniformly finished slope to the shoulder break that conforms to the Standard Drawings and the included sketch after compaction. Renovated shoulders shall smoothly tie the graded shoulder edge elevation to the adjoining elevation of the final pavement surface edge and final paved or stabilized shoulder surface edge.

**B. Manual shoulder restoration** shall be used to renovate shoulders in areas where existing guardrail will be undisturbed by adjacent plant mix or other operations specified in the contract.

Manual shoulder restoration shall include grading shoulders around existing guardrail by hand or other intensive production methods to appropriate slope and grade where sufficient material is present to restore the existing shoulders, grading existing shoulders to fill in low areas after shoulder material has been placed, or grading down areas where high shoulders exist due to debris buildup.

Manual shoulder restoration shall result in a uniformly finished slope to the shoulder break that conforms to the Standard Drawings and the included sketch after compaction. Restored shoulder work shall smoothly tie the graded shoulder edge elevation to the adjoining elevation of the final pavement surface edge and final paved or stabilized shoulder surface edge.

**ORDER NO.: 247**  
**CONTRACT ID. NO.: CM224PMF123441B**

**Note: Shoulder material specified in this Special Provision is the only allowable material for manual shoulder restoration work unless otherwise approved by the Engineer.**

Shoulder material (depending on the type of shoulder renovation operation specified in the Contract Documents or directed by the Engineer) shall be furnished and placed by the Contractor in low shoulder areas, then machined or manually graded off as necessary, and then compacted to provide a finished cross slope that conforms to the applicable Standard Drawings as well as the existing road profile grade.

Where guardrail is to be installed or reinstalled, the placement widths and limits of shoulder material shall be according to the detail requirements for the specific type of guardrail as designated in the Contract Documents and as shown in the Standard Drawings, the attached sketch, or as otherwise indicated in the Contract Documents. Guardrail height shall conform to the Standard Drawings for the applicable guardrail type once work is completed. This work shall proceed as directed by the Engineer.

**IV. MEASUREMENT AND PAYMENT**

**Machining shoulders** will be measured in linear feet along the adjacent edge of pavement and will be paid for at the Contract unit price per linear foot. The price shall include placing, grading, and compaction. This price shall also include removing and disposing of surplus, spilled, and tracked material resulting from the Contractor's operations.

**Manual shoulder restoration** will be measured in linear feet along the adjacent edge of pavement specified in the Contract or directed by the Engineer, and will be paid for at the Contract unit price per linear foot. The price shall include placing, grading, and compaction. This price shall also include removing and disposing of surplus, spilled, and tracked material resulting from the Contractor's operations.

**Virgin aggregate base material** will be measured in tons and will be paid for at the Contract unit price per ton. The price bid shall include furnishing and delivery.

**Shoulder Maintenance Material, if requested and authorized for use**, will be measured in tons or square yards and will be paid for at the Contract unit price per ton as bid in Section 0002 of the Special Provision Copied Note for Alternate Category Bid Items and Award of Contract. The price bid shall include furnishing and delivery.

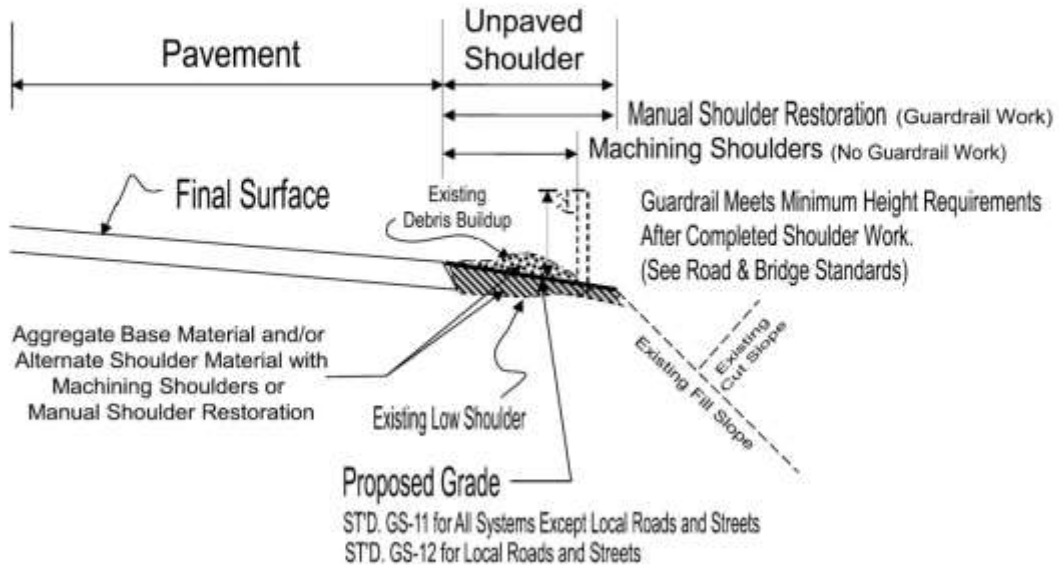
Tonnage for Shoulder Maintenance Material will be based on certified weigh tickets from the source of supply, or when supplied directly from the field, will be computed on the basis of 110 pounds per inch of depth per square yard, converted to tons.

Payment will be made under:

<b>Pay Item</b>	<b>Pay Unit</b>
Virgin Aggregate Base Material, Type ( ), No. ( )	Ton
Machining Shoulders	Linear Foot
Manual Shoulder Restoration	Linear Foot
Shoulder Maintenance Material	Ton

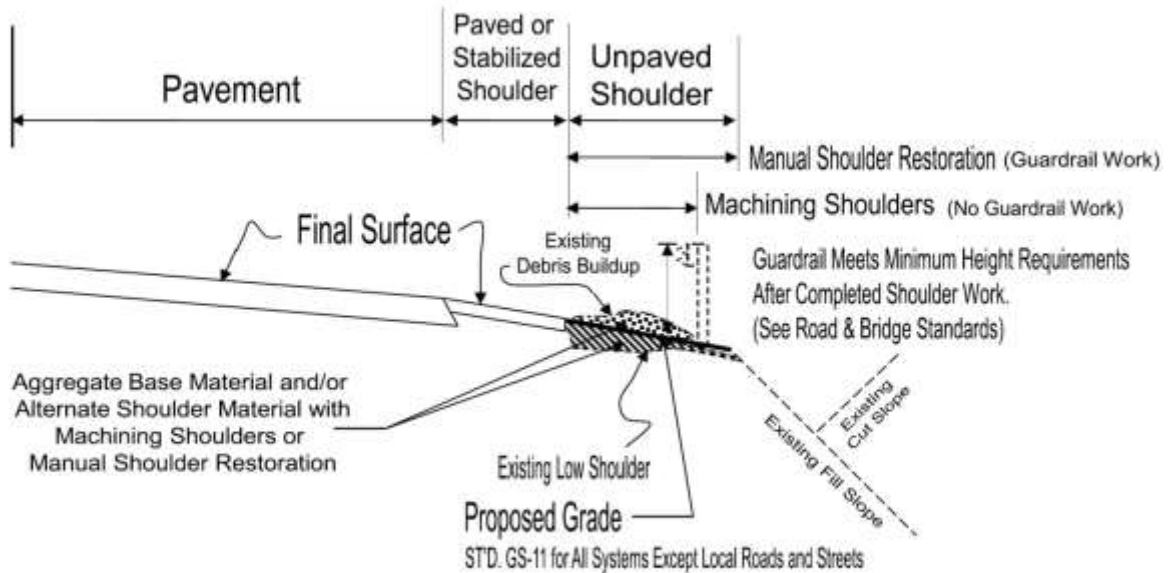


# SHOULDER RENOVATION



## Typical Section for Unpaved Shoulder

Not to Scale



## Typical Section for Paved or Stabilized Shoulder

Not to Scale

**ORDER NO.: 247**  
**CONTRACT ID. NO.: CM224PMF123441B**

[SP305-000110-00](#)

VIRGINIA DEPARTMENT OF TRANSPORTATION  
SPECIAL PROVISION FOR  
**STABILIZED AND PAVED SHOULDER OVERLAY**

December 3, 2015; Reissued July 12, 2016

**I. DESCRIPTION**

This work shall consist of furnishing and placing stabilized and paved shoulder overlay on existing stabilized and paved shoulder surfaces according to the Road and Bridge Standards and the Specifications. The purpose of this work is to provide a resurfaced shoulder with a slope and guardrail height that conforms to the Road and Bridge Standards, the Specifications and the requirements herein when work is completed.

**II. MATERIALS**

Materials for stabilized and paved shoulder overlay shall be according to the applicable requirements for the materials placed at the locations indicated in the Contract.

**III. PROCEDURES**

The Contractor shall furnish and place stabilized and paved shoulder overlay where specified. The material shall be spread, graded, and compacted according to the requirements for stabilized and paved shoulders in Section 305.03(e) of the Specifications or as indicated elsewhere in the Contract. When overlaying the existing stabilized shoulder, the material may be paced in a single lift.

At locations without guardrail or other guide device, the width of placement of stabilized and paved shoulder overlay shall be the same as the existing stabilized or paved shoulder.

At locations with guardrail or other guide device where the existing stabilized or paved shoulder does not extend to the guardrail or other guide device, the width of placement of stabilized and paved shoulder overlay shall be the same as the existing stabilized or paved shoulder.

At locations with guardrail or other guide device where the existing stabilized or paved shoulder extends to and behind the guardrail or other guide device, the width of placement of stabilized and paved shoulder overlay shall extend to the front edge of the guardrail.

The final compacted resurfaced stabilized and paved shoulder overlay slope shall be according to the requirements of the applicable standard shoulder design of Road and Bridge Standards and the Specifications. At locations where existing guardrail is not disturbed or where guardrail improvements or replacements are required, the finished guardrail height shall conform to the Road and Bridge Standards when work is completed.

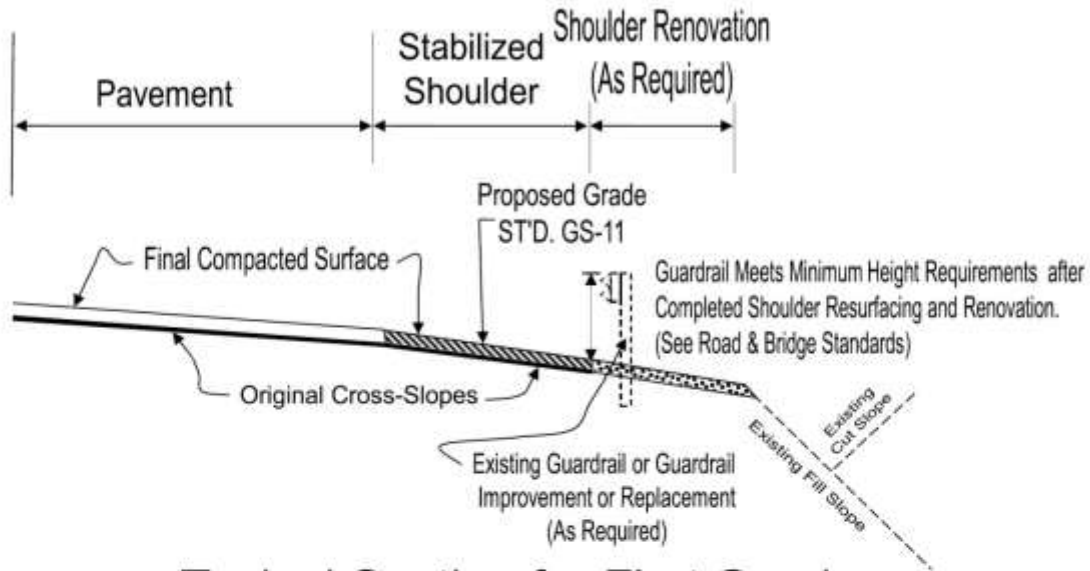
Shoulder renovation shall be as applied as required according to the Special Provision for **Shoulder Renovation**.

**IV. MEASUREMENT AND PAYMENT**

**Stabilized and paved shoulder overlay** will be measured and paid for according to the applicable items required for overlaying stabilized and paved shoulders.

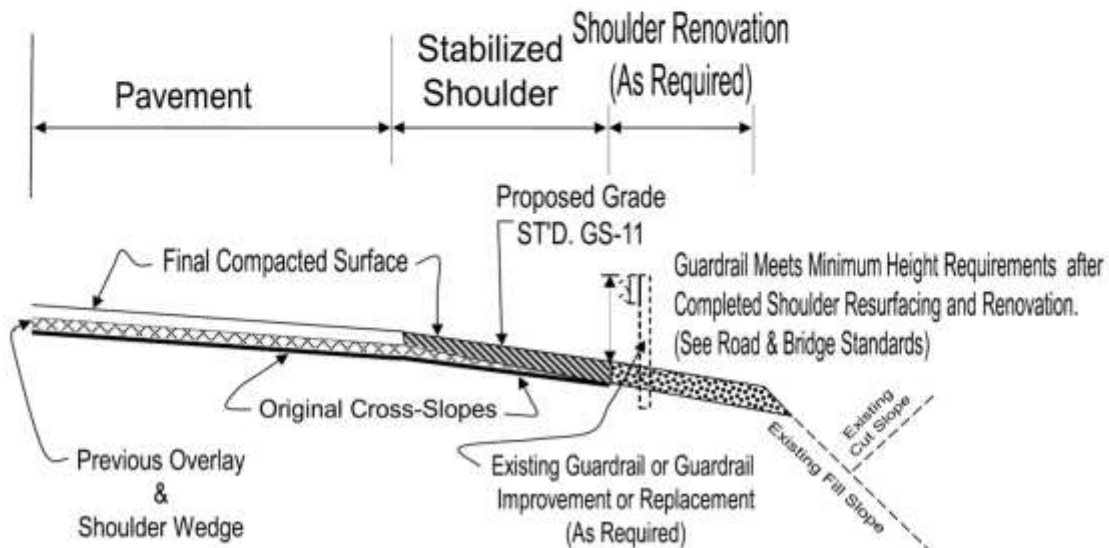
**Shoulder Renovation** will be measured and paid for according to the Special Provision for **Shoulder Renovation**.

# STABILIZED AND PAVED SHOULDER OVERLAY



Typical Section for First Overlay

Not to Scale



Typical Section for Previous Overlay

Not to Scale

**ORDER NO.: 247**  
**CONTRACT ID. NO.: CM224PMF123441B**

[SP315-000710-01 \[formerly SP315-070100-01\]](#)

VIRGINIA DEPARTMENT OF TRANSPORTATION  
SPECIAL PROVISION FOR  
**RIDEABILITY**  
**(For Asphalt Concrete Pavement)**

August 3, 2017

**I. Description**

For pavements designated in the Contract, the final ride quality acceptance will be based on the lowest average International Roughness Index (IRI) for each 0.01-mile section produced by a minimum of two test runs, using a South Dakota style road profiling device and reported for each travel lane. The device shall measure both wheelpaths with laser height sensing instruments. The Department will conduct the testing within 30 calendar days from Contractor's written request for testing following the completion of the final surface course and final pavement striping over the designated section. If temporary pavement marking is placed and the lanes are clearly delineated over the completed final surface course, the Contractor may request ride testing in writing and the Department will conduct testing within 30 calendar days from the request. The Department will conduct the testing as soon as possible upon receipt of the Contractor's testing request, providing the Contractor can arrange unimpeded access to the paved surface for constant highway speed test runs. Testing will be conducted according to VTM-106.

**II. Acceptance**

An IRI number in inches per mile will be established for each 0.01-mile section for each designated lane. The last 0.01-mile (52 feet) section before a bridge, the first 0.01-mile (52 feet) section after a bridge, and the beginning and end 0.01-mile (52 feet) sections of the final surface will not be subject to a pay adjustment.

Areas excluded from testing by the road profiling device will be tested using a 10-foot straightedge. The variation of the surface from the testing edge of the straightedge between any two contacts with the surface shall not be more than 1/4 inch. Humps and depressions exceeding the specified tolerance shall be subject to correction as directed by the Engineer, at no additional cost to the Department.

**1. Incentive-disincentive projects**

**A. General**

Tables A and B provide the acceptance quality of pavement based on the finished rideability for interstate and non-interstate roadways.

**TABLE A**  
**INTERSTATE SYSTEM**

IRI After Completion (Inches Per Mile)	Pay Adjustment (Percent Pavement Unit Price)
45.0 and Under	115
45.1-55.0	110
55.1-70.0	100
70.1-80.0	90
80.1-90.0	80

**ORDER NO.: 247**  
**CONTRACT ID. NO.: CM224PMF123441B**

90.1-100.0	70
100.1-120.0	60 or Subject To Corrective Action
120.1-140.0	40 or Subject to Corrective Action
140.1-160.0	20 or Subject to Correction Action
Over 160.0	0 or Subject to Corrective Action

---

**TABLE B**  
**NON-INTERSTATE SYSTEM**

IRI After Completion (Inches Per Mile)	Pay Adjustment (Percent Pavement Unit Price)
55.0 and Under	115
55.1-65.0	110
65.1-80.0	100
80.1-90.0	90
90.1-100.0	80
100.1-110.0	70
110.1-130.0	60 or Subject To Corrective Action
130.1-150.0	40 or Subject to Corrective Action
150.1-170.0	20 or Subject to Corrective Action
Over 170.0	0 or Subject to Corrective Action

The Engineer reserves the right to require corrective action according to Tables A and B. The method of correction shall be reviewed for approval by the Engineer and correction shall be performed at the Contractor's expense.

Corrections to the riding surface of Asphalt Concrete Pavement, other than remove-and-replace, will not be permitted prior to the Department's rideability testing. Reheating of asphalt concrete pavement will not be permitted. No incentives will be provided for sections on which corrective actions other than remove-and-replace have been performed before rideability testing.

The Engineer will be the sole determining authority on whether corrective measures submitted by the Contractor are acceptable. If the Contractor performs corrective action to the pavement without prior approval from the Engineer, no incentive payment will be made for the Asphalt Concrete Pavement within the limits where corrections were performed.

The Engineer may require correction of any or all adjoining traffic lanes or shoulders at the Contractor's expense to ensure uniform cross section.

Where corrections are made after the initial Department rideability test, the pavement will be retested by the Department to verify that corrections have produced the acceptable ride surface. No incentives will be provided for sections on which corrective actions have been required by the Engineer. Additional corrections may be required by the Engineer based on the retested IRI measurements at the Contractor's expense. In the event the corrective actions do not result in 100 percent payment, and not subject to further corrective action, the Contractor will be assessed the corresponding percent payment.

**B. Single-Lift Construction**

**ORDER NO.: 247**  
**CONTRACT ID. NO.: CM224PMF123441B**

An AC layer is defined as a material lift equal to or greater than 2.5 times the maximum nominal aggregate size for the AC mixes specified in the Contract. A material lift less than the specified application rate or less than 2.5 times the maximum nominal aggregate size for the AC mixes specified in the Contract is considered a “scratch course” and not an AC layer.

Where only one AC layer shall be placed, the Department will test pavement sites subject to this special provision prior to work by the Contractor. Upon request by the Contractor, the Department will provide the IRI testing results. If this IRI testing is conducted more than 180 calendar days prior to the scheduled beginning of the work, the Department or Contractor may request new IRI testing.

If the completed surface has IRI test results which indicate a 30 percent or more improvement in the ride quality, based on the average IRI (original surface and completed overlay) for each 0.1-mile length of each travel lane subject to this Special Provision, no corrective action will be required. This percent improvement is based on the 0.1-mile paved section average IRI and not the individual 0.01-mile increments. When the percent improvement is achieved for a 0.1-mile section, the payments (incentives, disincentives and full payment) for the individual 0.01-mile increments will be summed. The Contractor will then be paid the greater of the total adjusted payments or 100 percent for that 0.1-mile section.

This rideability specification does not relieve the Contractor from responsibility concerning workmanship according to the Specifications, other contract requirements or as defined by the Engineer.

**2. Incentive Only Projects**

For projects designated as “incentive only”, Table C will be applied for calculating pay adjustment. A pay adjustment calculation will be made at each 0.01 mile segment and summed over each 0.1 mile. Any penalties, calculated at each 0.1 mile, will be ignored for incentive only projects. Only pay adjustment calculation producing an incentive for each 0.1 mile (if any) section will be summed to determine the total incentive over the project. Therefore, no disincentive will be assessed over the entire project. The contractor will be paid the greater of the total incentive or 100 percent payment for the project. The standard exemptions will be applied to calculate the average IRI over the lane.

<b>TABLE C – INCENTIVE ONLY PROJECT</b>	
<b>IRI After Completion (Inches Per Mile)</b>	<b>Pay Adjustment (Percent Pavement Unit Price)</b>
60.0 and Under	115
60.1-70.0	110
70.1-85.0	100
85.1-95.0	90
95.1-105.0	80
105.1-115.0	70
115.1-135.0	60
135.1-155.0	40
155.1-175.0	20
Over 175.1	0

**ORDER NO.: 247**  
**CONTRACT ID. NO.: CM224PMF123441B**

Incentive only projects will not be subject to corrective action as a result of the rideability results. Ride testing prior to paving by the Department is not required for incentive only projects. Pay adjustments will be applied to the theoretical tonnage of the surface mix asphalt material for the lane width and section length tested. This rideability specification does not relieve the Contractor from responsibility concerning workmanship according to the Specifications, other contract requirements or as defined by the Engineer.

**III. Measurement and Payment**

Pay adjustments will be applied to the theoretical tonnage of the surface mix asphalt material for the lane width and section length tested (generally 12 feet wide and 52.8 feet long) based on testing prior to any corrective action directed by the Engineer. For the sections where corrective action is required, pay adjustment will be based on the testing after the corrective action has been accomplished.

**ORDER NO.: 247**  
**CONTRACT ID. NO.: CM224PMF123441B**

**SP315-000320-01**

VIRGINIA DEPARTMENT OF TRANSPORTATION  
SPECIAL PROVISION FOR  
**PAVEMENT SHOULDER WEDGE**

September 16, 2019

**I. DESCRIPTION**

This work shall consist of installing a consolidated pavement shoulder wedge shape at locations designated in the Plans or as directed by the Engineer. A pavement shoulder wedge is formed by a pavement shoulder wedge device to produce a consolidated wedge shaped pavement edge.

**II. APPLICABILITY**

The Contractor shall install shoulder wedge on new construction, mill-and-resurface and overlay projects that mill or pave to the edge of pavement. The Contractor shall install shoulder wedge on roadway segments where all of the following conditions are met:

- Open ditch sections (no curb and gutter).
- Paved Shoulder Widths 4 feet wide or less.
- Speed limits greater than 35 mph.
- Specified final asphalt surface lift thickness at least 1.25 inches.

The Contractor shall install shoulder wedge on other roadway segments directed by the Engineer.

The Contractor shall stop installation of the shoulder wedge in specific locations where any of the following field conditions are present, and resume installation after passing these locations:

- Driveways, intersections, interchanges, or bridges.
- Ditch slope begins within one foot from the edge of pavement or less than one foot of unpaved shoulder exists, if wedge is placed on unpaved shoulder as shown in Figures 3 and 4.
- Guardrail exists and the face of guardrail is within 3 feet from the existing edge of pavement.

**III. EQUIPMENT**

The Contractor shall use a wedge forming and consolidating device to create a sloped edge profile onto the roadway shoulder. The device shall accommodate varying wedge thicknesses from 1-1/4 inches to 5 inches, compact the asphalt concrete, and provide a sloped wedge equal to  $30^{\circ} \pm 5^{\circ}$  measured from the pavement surface cross slope extended. The device shall be adjustable to accommodate transitions to cross roads, driveways and obstructions. The Contractor shall not use a conventional single plate strike off.

The Engineer may require a test section constructed at the beginning of work to demonstrate the edge shape, after the compaction of the pavement surface, to the satisfaction of the Engineer

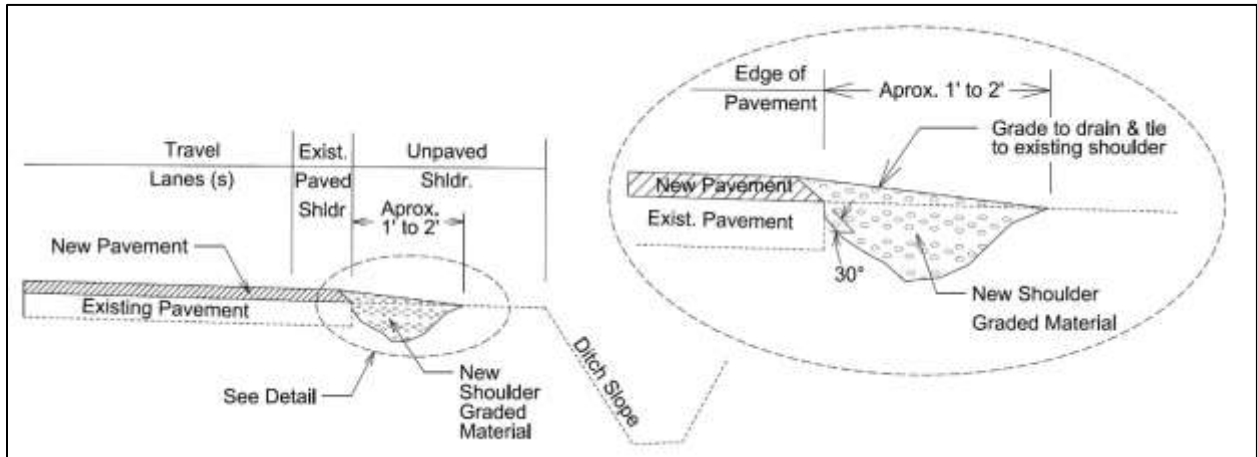
**IV. PROCEDURES**

The Contractor shall prepare the unpaved shoulder to accept the pavement shoulder wedge by removing soil build up and vegetation that exists within one foot from the existing edge of pavement.

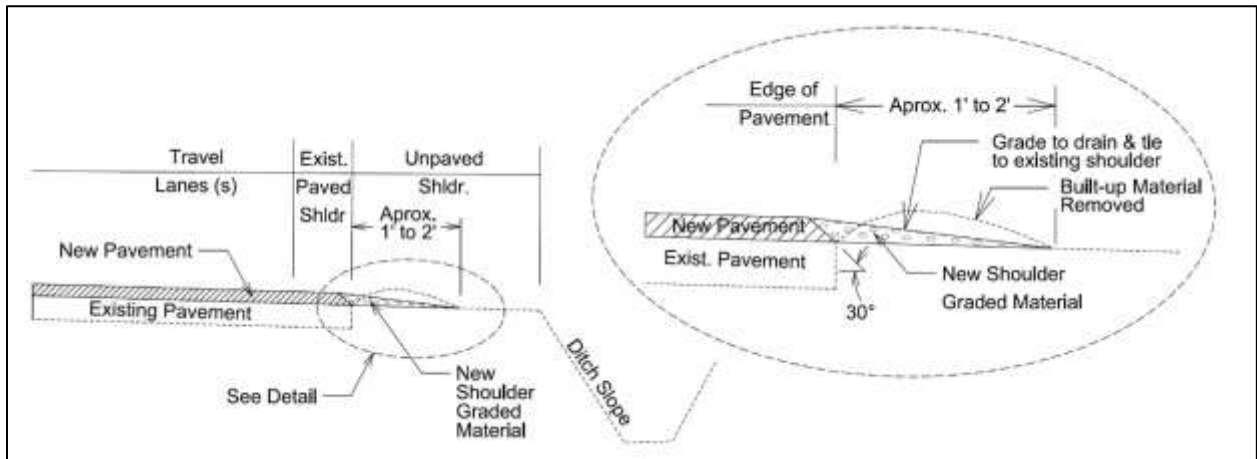
Pavement shoulder wedge shall be placed either on the existing pavement (Figures 1 and 2) or on the unpaved shoulder (Figures 3 and 4) as directed in the Plans or by the Engineer.



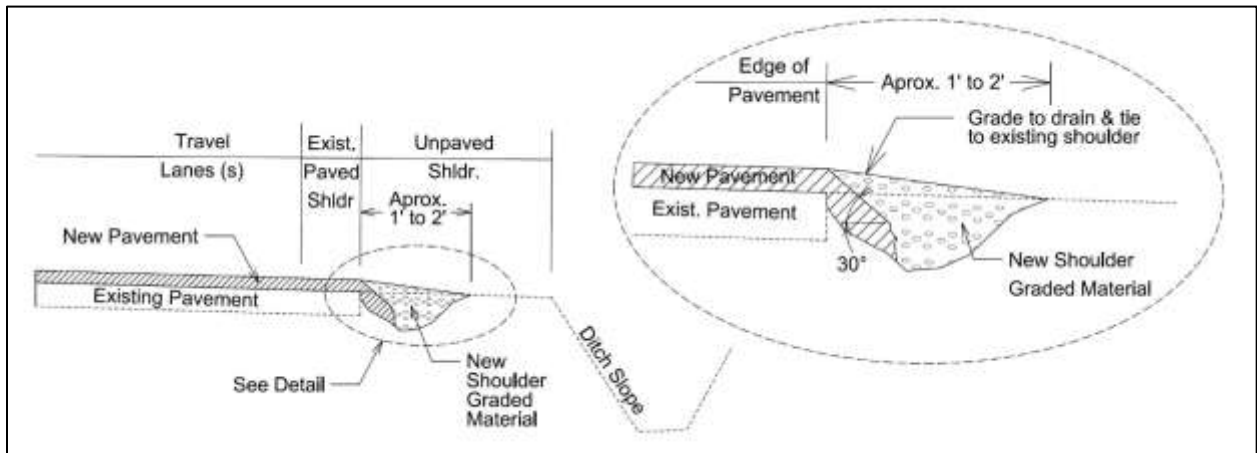
**ORDER NO.: 247**  
**CONTRACT ID. NO.: CM224PMF123441B**



**Figure 1: Wedge over Existing Pavement – Low Shoulder**

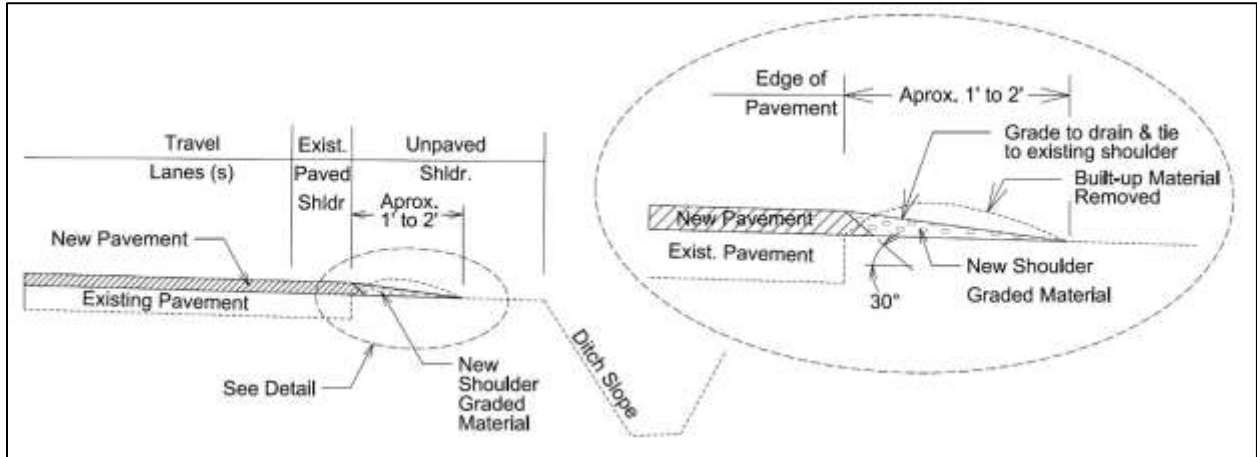


**Figure 2: Wedge over Existing Pavement – High Shoulder**



**Figure 3: Wedge over Unpaved Shoulder – Low Shoulder**

**ORDER NO.: 247**  
**CONTRACT ID. NO.: CM224PMF123441B**



**Figure 4: Wedge over Unpaved Shoulder – High Shoulder**

The Contractor shall attach the shoulder wedge device to the screed of the paver that confines the material at the end gate and extrudes the asphalt material in such a way that results in a compacted wedge shape pavement edge equal to  $30^{\circ} \pm 5^{\circ}$  measured from the pavement surface cross slope extended. Contact shall be maintained between the device and the road shoulder surface and allow for transitions to cross roads, driveways and obstructions. The Contractor shall use the device to consolidate the asphalt to increase the density of the extruded profile.

The Contractor may perform handwork such as transitions at driveways, intersections, interchanges, and bridges or other areas approved by the Engineer.

After paving is complete, shoulders, where specified, shall be constructed to smoothly tie the graded shoulder edge elevation to the adjoining elevation of the final pavement top surface edge or final paved or stabilized shoulder top surface edge. The shoulder shall also be graded to obtain a uniform shoulder slope to the shoulder break that conforms to the Standard Drawings.

The Contractor shall furnish and place aggregate base material where specified. The material shall be spread, graded, and compacted in accordance with Section 305.03(e) of the Specifications, except for the shaping of the subgrade which will not be required.

The Contractor shall follow the SWPPP and ESC Plan in the Contract.

## **V. MEASUREMENT AND PAYMENT**

**Pavement shoulder wedge**, except for shoulder preparation, will not be measured for separate payment but shall be included in the cost for Asphalt Concrete.

**Pavement shoulder wedge prep** will be measured in linear feet along the adjacent edge of pavement and will be paid for at the contract unit price per linear foot. This price shall include grading the existing unpaved shoulder to accommodate the pavement shoulder wedge using mechanized equipment or manual methods. This price shall also include the removal and disposal of surplus, tracked, and spilled material resulting from the Contractor's operations

**Aggregate base material** used to repair and fill low shoulders will be measured and paid for in accordance with Section 305 of the Specifications.

Payment will be made under:

**ORDER NO.: 247**  
**CONTRACT ID. NO.: CM224PMF123441B**

<b>Pay Item</b>	<b>Pay Unit</b>
Pavement shoulder wedge prep	Linear Foot

**ORDER NO.: 247**  
**CONTRACT ID. NO.: CM224PMF123441B**

**SP512-000120-04**

VIRGINIA DEPARTMENT OF TRANSPORTATION  
SPECIAL PROVISION FOR  
**SECTION 512—MAINTAINING TRAFFIC FOR RESURFACING PROGRAM**

June 12, 2023

**SECTION 512—MAINTAINING TRAFFIC** of the Specifications is amended as follows:

**Section 512.03(a) Temporary Signs** is amended to delete the 9<sup>th</sup> paragraph.

**Section 512.03(b) Flagger Service** is amended to include the following:

The Contractor shall have no less than one flagger each at the beginning and ending of each work site. The Contractor shall also have flaggers at all roadway intersections within the work site, as required by the VWAPM. When the Engineer determines additional flaggers are necessary at the work site, the Contractor shall furnish them. On a divided highway the Engineer will instruct the Contractor where flaggers shall be stationed.

Radio communications shall be used between flaggers unless all flaggers have clear, unobstructed line of sight with each other at all times.

**Section 512.03(d) Pilot Vehicles** is amended to include the following:

Pilot vehicles shall be used on all roads where modified seal treatments, seal treatments using latex modified emulsified asphalt (CRS-2L) and other seal treatments on roads having more than 49 ADT are being placed, unless otherwise directed by the Engineer.

Radio communication shall be used between all pilot vehicles and flaggers.

**Section 512.03(q) Type 3 Barricades** is amended to add the following:

When closing sidewalks with Type 3 barricades, the barricades shall be wide enough to cover the width of the sidewalk.

**Section 512.03(s) Portable Changeable Message Sign (PCMS)** is amended to replace the fifth paragraph with the following:

During emergency situations the Contractor shall make every effort to deploy units it has assigned to the project. However, if the number of units shown on the plans are already in operation and cannot be reassigned to handle the emergency situation, the Contractor shall immediately contact the Engineer. The Engineer will then make a determination as to the most expeditious manner in which to deploy units for emergency use, whether by using Department supplied units, directing the Contractor to reassign those units he has committed to the project, or having the Contractor supply additional units as needed. In these circumstances, the cost for such additional units that are authorized by the Engineer shall be paid for according to Section 512.04 of this Special Provision.

**Section 512.03(y) Temporary pedestrian accommodations** is inserted as follows:

**Temporary pedestrian accommodations:** The Contractor shall close all pedestrian pathways that cross a milled or performance-planed surface in accordance with the VWAPM. The Contractor shall

**ORDER NO.: 247**  
**CONTRACT ID. NO.: CM224PMF123441B**

establish pedestrian detours where determined practical by the Engineer. Pedestrian pathways shall be re-opened when that segment of highway is opened to vehicles.

**Section 512.04 Measurement and Payment** is replaced with the following:

**Maintenance of Traffic** will be paid for at the lump sum price per schedule as designated in the Contract. Such traffic control shall include furnishing, erecting, installing or employing, and maintaining traffic control devices.

Payment for traffic control will be made incrementally as a percentage on the lump sum price based on the percentage of tonnage or square yards (as with slurry seal, latex emulsion, and surface treatment contracts) and placed on the schedule for the payment period covered by the appropriate progress estimate.

Additional traffic control layout detail items that are determined and authorized by the Engineer to be necessary to ensure the safety of the traveling public and are **in addition to the number required** by the traffic control layout details in the *VWAPM* and the Contract, will be measured and paid for as follows; therefore, the provisions of Section 104.02 of the Specifications will not apply:

- **Pilot vehicles** shall include vehicles, drivers, necessary warning devices, fuel and maintenance. Where additional pilot vehicles are required as determined and authorized by the Engineer, such vehicles will be measured in hours of actual use and will be paid for at the rate of **\$30** per hour of employed use.
- **Electronic arrows** shall include arrow boards, fuel, maintenance, and a truck or trailer having flashing vehicle warning lights. Where additional electronic arrows beyond those required by the *VWAPM* are determined to be necessary and authorized by the Engineer, electronic arrows will be measured in hours of actual use and will be paid for at the rate of **\$5** per hour for each hour of employed use.
- **Warning lights** for use on sign panels or installed on traffic barrier service will not be measured for separate payment. The cost thereof shall be included in the price for other appropriate pay items. This shall include maintaining, relocating, and removing warning lights as needed.
- **Group 1 channelizing devices** will not be measured for separate payment. The cost thereof shall be included in the price for other appropriate pay items.
- **Group 2 channelizing devices** shall include furnishing and maintaining devices, removing devices when no longer required, and signs. Where additional Group 2 channelizing devices beyond those required by the *VWAPM* are determined to be necessary and authorized by the Engineer, those Group 2 channelizing devices will be measured in days and paid for at the rate of **\$1** per day per device. . When group 2 channelizing devices are moved to a new location or are removed and re-installed at the same location, the relocated devices will be measured for separate payment. However, when Group 2 channelizing devices are moved laterally within the lane or from one lane to another or from a shoulder into a lane by simply moving the devices across the lane edge line without removal from the roadway, no additional payment will be made.
- **Traffic barrier service** will not be measured for separate payment. The cost thereof shall be included in the price for other appropriate pay items. This shall include warning lights, delineators, barrier vertical panels, fixed object attachments, patching restraint holes, fixed object attachments used on traffic barrier service in locations where existing guardrail is in place including restoring existing guardrail to its original condition, maintaining, and removing traffic barrier service when no longer required.

**ORDER NO.: 247**  
**CONTRACT ID. NO.: CM224PMF123441B**

- **Traffic barrier service guardrail terminal** will not be measured for separate payment. The cost thereof shall be included in the price for other appropriate pay items. This shall include furnishing, installing, moving to a new location as directed or approved by the Engineer, and removing when no longer needed.
- **Impact attenuator service** will not be measured for separate payment. The cost thereof shall be included in the price for other appropriate pay items. This shall include Impact attenuators used with barrier openings for equipment access.
- **Aggregate material** will not be measured for separate payment. The cost thereof shall be included in the price for other appropriate pay items. This shall include preparing the grade and furnishing, placing, maintaining, and removing material as required.
- **Type 3 barricades** will not be measured for separate payment. The cost thereof shall be included in the price for other appropriate pay items. This shall include barricades with retroreflective sheeting, sandbags, maintaining, relocating to new locations, and removing the type 3 barricades when no longer required.
- **Pedestrian barricade devices** will not be measured for separate payment. The cost thereof shall be included in the price for other appropriate pay items. This shall include maintaining, sand bag ballast, relocating to new locations, and removing when no longer required.
- **Temporary (construction) signs** shall include furnishing, installing, maintaining, covering, uncovering, relocating, and removing the following: temporary signs, temporary sign panels, sign panel bracing, sign supports, hardware, delineators, and flags.

When additional temporary signs beyond those required by the VWAPM are determined to be necessary and authorized by the Engineer, the additional signs will be paid for at **\$20** per square foot..

- **Truck mounted attenuators** shall include the truck mounted attenuator, mounting vehicle, warning lights, vehicle-mounted signs, electronic arrow boards used in lieu of vehicle warning lights,, and maintenance. Electronic arrow boards required on truck-mounted attenuator support vehicles in moving or mobile operations will be measured and paid for separately.

When truck-mounted attenuators beyond those required by the Contract are determined to be necessary and authorized by the Engineer, these will be measured in hours of actual use required, and will be paid for at the rate of **\$22** per employed hour. When electronic arrows are required and authorized as determined by the Engineer and not incidentally mounted (and permitted) on such truck mounted attenuator support vehicles, they will be paid for separately as specified herein.

- **Portable Changeable Message Signs (PCMS)**, not designated in the Contract as a separate pay item but where additional Portable Changeable Message Signs are required as determined and authorized by the Engineer, these will be measured in hours of actual use and paid for at the rate of **\$15** per hour for each hour of employed use. This price shall include mobilizing the units to the project, maintenance, operation, and repositioning the units.

**Flagger Service** will be measured in hours of operations, per flagger, as required by Section 512.03(b) and authorized or approved by the Engineer, and will be paid for at the Contract hour price. This price shall include paddles, safety equipment, and required communication gear.

**Automatic Flagger Assistance Devices (AFADs)** may be used instead of Flagger Service when approved by the Engineer, at no additional cost to the Department. This price shall include furnishing or mobilizing the AFAD to the project, services of the trained AFAD operators,

**ORDER NO.: 247**  
**CONTRACT ID. NO.: CM224PMF123441B**

channelizing devices, safety equipment, fuel, necessary warning devices, maintenance, and removal. Separate payment for the certified flagger operating the AFAD will not be made.

**Portable Temporary Rumble Strip (PTRS) Array** will not be measured for separate payment. The cost thereof – including installing, maintaining, removing devices when no longer required, and relocating throughout the day - shall be included in the price for the LS Maintenance Of Traffic pay item. An Array shall consist of three rumble strips.

**Eradication of existing pavement markings** will be measured in linear feet of a 6-inch width or portion thereof as specified herein. Widths that exceed a 6-inch increment by more than 1/2 inch will be measured as the next 6-inch increment. Measurement and payment for eradication of existing pavement markings specified herein shall be limited to linear pavement line markings. Eradication of existing pavement markings will be paid for at the contract unit price per linear foot. This price shall include removing linear pavement line markings, cleanup, and disposing of residue.

**Eradication of existing nonlinear pavement markings** will be measured in square feet based on a theoretical box defined by the outermost limits of the nonlinear pavement marking as defined in Standard PM-10 of the *VDOT Road and Bridge Standards*. Nonlinear pavement markings shall include but not be limited to stop lines, arrows, images, symbols, and messages. Eradication of existing nonlinear pavement markings will be paid for at the contract unit price per square foot. This price shall include removing nonlinear pavement markings, cleanup, and disposing of residue.

**Basic Work Zone Traffic Control** – Separate payment will not be made for providing a person to meet the requirements of Section 105.14 of the Specifications. The cost thereof shall be included in the price of other appropriate pay items.

**Intermediate Work Zone Traffic Control** - Separate payment will not be made for providing a person to meet the requirements of Section 105.14 of the Specifications. The cost thereof shall be included in the price of other appropriate pay items.

**Temporary (construction) pavement markings**, including FTPMs used in substitution of temporary pavement markings, will be measured and paid for in accordance with the Special Provision for Pavement Markings and Markers for Resurfacing Program.

Payment will be made under:

<b>Pay Item</b>	<b>Pay Unit</b>
Flagger Service	Hours
Maintenance of Traffic (Schedule)	Lump Sum
Eradication of existing pavement marking	Linear foot
Eradication of existing nonlinear pavement marking	Square foot

**ORDER NO.: 247**  
**CONTRACT ID. NO.: CM224PMF123441B**

**SP515-000100-00**

VIRGINIA DEPARTMENT OF TRANSPORTATION  
SPECIAL PROVISION FOR  
**COLD PLANING (MILLING) ASPHALT CONCRETE OPERATIONS**

July 12, 2016

**I. DESCRIPTION**

This provision shall govern cold planing (milling) asphalt concrete operations in preparation for pavement repair and/or pavement overlay. Cold planing of asphalt concrete pavement shall be performed according to Section 515 of the Specifications and the requirements herein.

**II. GENERAL PROCEDURES**

The Contractor is permitted to perform either regular pavement planing or performance pavement planing to the Contract specified depth or as directed by the Engineer in order to provide a uniform sound substrate prior to paving roadways designated in the schedules according to Section 315 of the Specifications, the requirements herein, or elsewhere in the Contract.

**A. Regular and Performance Planing**

The following general conditions apply to either type of cold pavement planing:

Limitations of operations for planing shall be performed according to Section 108.02 of the Specifications, other Contract specific requirements, and as specified herein.

Where the depth of planing designated in the Contract or directed by the Engineer is 2 inches or less, the Contractor shall have the option of planing the abutting lane or shoulder on alternate days or squaring up the planing operation at the end of each work shift. However, abutting lanes or shoulders shall be planed and squared up regardless of planing depth prior to holidays or any temporary shutdowns.

Where the depth of planing designated in the Contract or directed by the Engineer is greater than 2 inches in the Contract, the Contractor shall square up the planing operation at the end of each workday or plane adjacent lanes including abutting shoulders within the same day for the length of that day's planing operation.

The Contractor will not be permitted to plane a portion of the width of a travel lane, ramp, loop or shoulder and leave it unpaved and open to traffic. Abutting shoulders may also be planed during single and multiple lane planing operations. Planing operations shall be planned and performed to maintain positive drainage according to Section 315.05(c) of the Specifications.

In the event an emergency or an unforeseen circumstance such as equipment failure or breakdown occurs during the Contractor's operations and such emergency or unforeseen circumstance within his control prevents the Contractor from squaring up the planed surface on adjacent lanes prior to a holiday or temporary shutdown, any additional signage, traffic control devices or temporary markings or markers required to protect the traveling public shall be the Contractor's responsibility and at his expense.

Where uneven pavement joints exist either transversely or longitudinally at the edges of travel lanes, the Contractor shall provide advance warning signage and traffic control devices to inform the traveling public according to the details provided in the Contract for the scope of operation he is performing. The cost for such advance warning signage and traffic control devices shall be included in the cost of other appropriate items



**ORDER NO.: 247**  
**CONTRACT ID. NO.: CM224PMF123441B**

Where appropriate according to Contract requirements and site specific conditions, the existing asphalt concrete layers shall be planed to permit the transition of the top course of the asphalt concrete overlay according to the details of the ACOT-1 Standard. Any sub-courses termination may be notched into the existing pavement or blended with the next course of pavement.

**B. Performance Planing Only Limitations:**

When the Contractor elects to performance plane on roadways specified to be planed to a depth of 2 inches or less, the Contractor shall performance plane only that amount of pavement which can be paved back within the time allowance specified herein for completion of planing the roadway or portion of roadway. The Contractor is required to perform pavement surface testing as specified in Section 515.04 of the Specifications to verify the Contractor has achieved the acceptable surface texture specified in that Section prior to opening the performance planed surface to traffic. Additional traffic control devices and signage required for the extended pave back time allowance specified herein for performance planing operations versus the traffic control devices required for the pave back operations for regular pavement planing operations specified herein shall be at the Contractor's expense.

**III. ROADWAY CLASSIFICATION LIMITATIONS**

The following restrictions, based on the type of roadway, shall apply:

**A. All Interstates and other Limited Access Roadways including Ramps and Loops posted at 55 Mph or Greater**

**1. Regular planing and performance planing in multiple lanes**

The Contractor shall plan, execute and maintain pavement planing operations to avoid trapping water on the roadway. On roadways with a combination of 3 or 4 lanes and shoulders (i.e. 2 travel lanes and 1 or 2 shoulders in one direction) where the travel lanes and shoulders will not be completely planed to drain prior to the start of paving operations, planing shall be performed so that water will not pond on the travel surface. When the Contract does not include the removal of the shoulder at the specific roadway planing location, the Contractor shall cut drainage outlets through the shoulder at locations the Engineer designates (excluding curb and gutter sections) for those portions of the planed roadway that are to be opened to traffic. The Contractor shall restore the shoulders to their original grades once paving operations are completed, unless otherwise directed by the Engineer. The cost for cutting and restoring roadway shoulders shall be included in the price bid for other items of work.

On roadways with a combination of 5 or more lanes and shoulders (i.e. 3 or more travel lanes and 2 shoulders in one direction), the extent to which the interior lanes shall be planed will be such that the planed portions can be repaved within the work-zone time limits unless provisions are made to mitigate the ponding of water (i.e., milling adjacent lane(s) and shoulders or cutting drainage outlets through the shoulder).

Ramps and exits shall be planed in such a manner that an even longitudinal joint (elevation difference of greater than 1 inch) is not left for vehicles to cross within the posted speed limits in a "run on" situation. To prevent this, the Contractor can plane ramps and exits to the extent that the joint line between new and existing pavement crossed by traffic is traversed at an angle close to ninety (90) degrees per the ACOT-1 Standard for temporary transverse joints or can perform tapered planing along the ramp/exit longitudinal joint to provide a smooth transition for vehicles to cross, or can square up ramp or exit pavement with the adjacent mainline lane at the time of installation.

**ORDER NO.: 247**  
**CONTRACT ID. NO.: CM224PMF123441B**

The following additional restrictions will apply to roadways where **regular pavement planing** is applicable:

- The Contractor will be limited in the case of regular pavement planing, whether in a single lane or multiple lane operation, to only that amount of pavement that can be paved back within 24 hours of completion of planing that roadway or portion of roadway.
- The Contractor shall pave all roadways, ramps and loops planed during the week before that weekend.
- On roadways with a combination of 4 or more lanes and shoulders (i.e. 2 or more travel lanes and 2 shoulders) in one direction, all travel lanes must be paved back before the weekend. Up to two thousand five hundred (2,500) feet of shoulder may be planed and left over the weekend provided the portion of planed shoulder left unpaved over the weekend is paved within 24 hours after the end of the weekend period.

The following additional restrictions will apply to roadways where **performance pavement planing** is planned by the Contractor:

- Performance planing may be performed in multiple lanes across the entire widths of the lanes up 4 miles of travel lane unless otherwise stated in the Contract. Performance planed travel lanes surfaces must be paved back within 96 hours from the end of the performance planing operation
- Where the Contractor decides to performance plane multiple lanes, the Contractor shall be responsible for furnishing and installing advance warning signage and traffic control devices to inform the traveling public according to the details provided in the Contract. Temporary pavement markings and markers used for lane demarcation on performance planed surfaces will be according to Section 704.04 of the Specifications and the *Special Provision for SECTION 704—PAVEMENT MARKINGS AND MARKERS* included in the Contract. The cost for such warning devices and advance signage required by multiple lane planing operations shall be included in the cost of other appropriate items unless otherwise specified in the Contract by a specific pay item(s) for separate payment.

**B. Non-Limited Access Roadways with an ADT of 10,000 or Greater (Traffic Group XV and above) and a Posted Speed Limit of 45 Mph or Greater**

**1. Regular planing and performance planing in multiple lanes**

The Contractor shall plan and proceed with the pavement planing operation to avoid trapping water on the roadway. On roadways with a combination of 3 or 4 lanes and shoulders (i.e. 2 travel lanes and 1 or 2 shoulders) in one direction where the travel lanes and shoulders will not be completely planed prior to the start of paving operations, planing operations shall be performed so water will not pond on the travel surface. When the Contract does not include the removal of the shoulder, the Contractor shall cut drainage outlets through the shoulder at locations the Engineer designates, excluding curb and gutter sections, for those portions of the planed roadway that are to be opened to traffic. The Contractor shall restore the shoulders to their original grades once paving operations are completed, unless otherwise directed by the Engineer. The cost for cutting and restoring the roadway shoulder shall be included in the price bid for other items of work.

On roadways with a combination of 5 or more lanes and shoulders (i.e. 3 or more travel lanes and 2 shoulders in one direction), the extent of pavement planing on the interior lanes

**ORDER NO.: 247**  
**CONTRACT ID. NO.: CM224PMF123441B**

shall be such that the planed surface can be repaved within the timeframe of the work-zone time limits unless provisions are made to mitigate the ponding of water (i.e. planing adjacent lane(s) to mitigate the ponding of water).

The following additional restrictions will apply to roadways where **performance pavement planing** is planned by the Contractor:

- Performance planing may be performed in multiple lanes across the entire widths of the lanes up a total of 4 miles of travel lane unless otherwise stated in the Contract.
- Performance planed travel lane surfaces must be paved back within 10 days from the start of the performance planing operation.
- Where the Contractor decides to performance plane multiple lanes, the Contractor shall be responsible for furnishing and installing advance warning signage and traffic control devices to inform the traveling public according to the details provided in the Contract. The cost for such warning devices and advance signage required by multiple lane planing operations shall be included in the cost of other appropriate items unless otherwise specified in the Contract by a specific pay item(s) for separate payment. Temporary pavement markings required by such operations will be handled according to Section 704.04 and the *Special Provision for SECTION 704—PAVEMENT MARKINGS AND MARKERS* included in the Contract.

The following additional restrictions will apply to roadways where **regular pavement planing** is applicable:

- The Contractor will be limited whether in a single lane or multiple lane operation, to only that amount of pavement that can be paved back within 24 hours of completion of planing that roadway or portion of roadway.
- The Contractor shall pave all roadways that have been regular planed during the week before that weekend.
- On roadways with a combination of 4 or more lanes and shoulders (i.e. 2 or more travel lanes and 2 shoulders in one direction, all travel lanes must be paved back before the weekend. Up to two thousand five hundred (2,500) feet of shoulder may be planed and left over the weekend provided the portion of planed shoulder left unpaved over the weekend is paved within 24 hours after the end of the weekend period.

**C. All Other Roadways**

**1. Regular Pavement Planing (single or multiple lanes)**

If the Contractor elects to perform regular pavement planing the Contractor will be permitted to leave up to two miles of travel lane open to the traveling public provided such planing (milling) is performed across the entire lane width. This same total length restriction will apply in cases where multiple-lane regular pavement planing is permitted in the Contract or allowed by the Engineer. The Contractor will be limited in the case of regular pavement planing, whether in a single lane or multiple lane operation, to only that amount of pavement that can be paved back within 96 hours of completion of planing that roadway or portion of roadway.

**2. Performance Pavement Planing**

When the Contractor elects to performance plane roadways specified to be planed to a depth of 2 inches or less, the Contractor shall plane only the amount of pavement that can

**ORDER NO.: 247**  
**CONTRACT ID. NO.: CM224PMF123441B**

be paved back within 14 calendar days of completion of planing that roadway or portion of roadway. The Contractor is required to perform pavement surface testing as specified in Section 515.04 of the Specifications to verify the Contractor has achieved the acceptable surface texture prior to opening the performance planed surface to traffic. The additional traffic control devices and signage required for the 14 calendar day pave back operation allowance for performance planing operations shall be at the Contractor's expense.

Temporary pavement markings required by such operations will be handled according to Section 704.04 and the *Special Provision for SECTION 704—PAVEMENT MARKINGS AND MARKERS* included in the Contract.

Roadways on which the roadway edges (i.e. edge milling) are to be planed shall be paved back within 10 days from the completion of the planing operation.

**IV. MEASUREMENT AND PAYMENT**

Measurement and payment will be according to Section 515.05 of the Specifications.

**ORDER NO.: 247**  
**CONTRACT ID. NO.: CM224PMF123441B**

**SP704-000100-06**

VIRGINIA DEPARTMENT OF TRANSPORTATION  
SPECIAL PROVISION FOR  
**SECTION 704—PAVEMENT MARKINGS AND MARKERS FOR RESURFACING PROGRAM**

June 12, 2023

**SECTION 704 – PAVEMENT MARKINGS AND MARKERS** of the Specifications is replaced with the following:

**704.01 – Description**

This work shall consist of establishing the location of retroreflective pavement markings and installing pavement markings and pavement markers in accordance with the *MUTCD*, the Contract, and as directed by the Engineer.

**704.02 – Materials**

- (a) **Pavement Markings** shall conform to Section 246.
- (b) **Glass Beads** and retroreflective optics materials shall conform to Section 234.
- (c) **Pavement Markers** shall conform to Section 235.
- (d) **Contrast Pavement Markings** shall conform to Section 246.

For Type B, Class VI pavement marking materials that are to be applied to latex emulsion or slurry seal surfaces, the selected Type B, Class VI manufacturer shall be a manufacturer that approves and warrants their product for application on that type of surface.

The Contractor shall use a Department approved inventory tracking system for all materials received from the manufacturer. Shipment of materials from such inventory shall be accompanied by a signed Form C-85 containing the following certification statement:

*Material shipped under this certification has been tested and approved by VDOT as indicated by laboratory test numbers (MS#) listed hereon.*

**Section 704.03 – Procedures**

Once received by the Contractor, the Contractor shall store all materials in accordance with the manufacturer's instructions until the day of installation, unless the Engineer otherwise authorizes. Pavement marking material shall not be installed if the material has exceeded its shelf life, has been improperly stored, has deteriorated or is otherwise damaged.

Pavement markings and markers shall be installed as per the manufacturer's installation instructions. The Contractor shall furnish a copy of those installation instructions to the Engineer prior to installation.

The Contractor shall have a certified Pavement Marking Technician present during all temporary pavement marking, permanent pavement marking, and pavement marker operations, except Flexible Temporary Pavement Marker (FTPM) installation.

**ORDER NO.: 247**  
**CONTRACT ID. NO.: CM224PMF123441B**

The Contractor may mark the locations of proposed permanent markings on the roadway by installing premarking materials. Premarkings may be accomplished by installing removable tape, chalk, or lumber crayons, except pavement markings such as stop lines, crosswalks, messages, hatching, etc., shall be premarked using chalk or lumber crayons. Premarkings for yellow markings may be white or yellow. Premarkings for other colors shall be white.

When tape is used as a premarking material, premarking shall consist of 4- inch by 4-inch-maximum squares or 4-inch-maximum diameter circles spaced at 100-foot minimum intervals in tangent sections and 50-foot minimum intervals in curved sections. At locations where the pavement marking will switch colors (e.g., gore marking) the ends of the markings may be premarked regardless of the spacing.

When the Contractor uses chalk or lumber crayon as a premarking, the entire length of the proposed pavement marking may be premarked.

Premarkings shall be installed so their installation will not affect the adhesion of the permanent pavement markings. When removable tape is used as the premarking material and the lateral location of such premarkings to location of the final pavement markings exceeds 6 inches, the tape shall be removed at no additional cost to the Department.

The Contractor shall provide staking in the field that documents any changes in passing zones on undivided roads and placement of railroad crossing markings. Any changes to these markings that are specified in the Contract shall be staked. The Contractor shall complete all staking and notify the Engineer at least 14 days before the scheduled start of resurfacing operations.

The Contractor shall reference this staking when installing temporary markings, and for the premarking to be done in advance of permanent marking installation. The stakes shall be removed at the conclusion of the project.

All existing markings shall be replaced with permanent markings of the same width, color, size, and location unless otherwise directed in the PM Series Standard Drawings, in the Contract, or by the Engineer. All replacement markers shall have the same retroreflector colors (front and back) as existing markers unless otherwise directed in the Contract or by the Engineer.

The Contractor shall sweep clear all surface-treated, slurry seal, and latex emulsion roadways before installation of permanent pavement markings. Any loose aggregate remaining on the surface shall be blown-out with an air compressor or other approved method.

The Contractor shall exercise caution and protect the public from damage while performing pavement marking operations. The Contractor shall be responsible for the complete preparation of the pavement surface, including, but not limited to, removing dust, dirt, loose particles, oily residues, curing compounds, concrete laitance, residues from eradication, and other foreign matter immediately before installing pavement markings. The pavement surface shall be clean and dry at the time of pavement marking installation and shall be tested in accordance with VTM 94 before permanent installation, with the VTM 94 test results noted on Form C-85. The Contractor shall provide the equipment indicated in VTM 94 that are needed to perform the moisture test before application.

If the Contractor cannot have permanent pavement markings installed within the time limits specified, the Contractor shall install and maintain temporary pavement markings within the same time limits at no additional cost to the Department until the permanent pavement markings can be installed. Installation, maintenance, and removal or eradication of temporary pavement markings shall be according to Section 512.

Liquid markings shall be applied so as to prevent splattering and overspray and shall be protected from traffic until track free by the use of traffic control guarding or warning devices as necessary. If a vehicle crosses a pavement marking and tracks it or if splattering or overspray occurs, the affected marking and

**ORDER NO.: 247**  
**CONTRACT ID. NO.: CM224PMF123441B**

resultant tracking, overspray, or splattering shall be completely removed and new markings applied at the Contractor's expense.

Truck-mounted equipment for application of liquid long line Type B markings shall be capable of hot applying liquid and/or plastic markings and broadcasting glass beads uniformly over the entire surface of the marking. Truck mounted equipment tanks shall be equipped with a mechanical agitator to keep the pavement marking materials thoroughly mixed at all times. Materials shall be blended, heated, and applied in accordance with the manufacturer's installation instructions. Markings shall be applied in widths of 4 through 8 inches in accordance with the the Plans and Specifications. Equipment shall be capable of applying two pavement lines, either solid or skip, at the same time when double line markings are required.

Non-truck mounted equipment shall be regulated to allow for calibration of the amount and type of material applied.

The Contractor shall be responsible for ensuring that equipment is thoroughly cleaned between changes in colors or types of materials.

Markings shall not be installed directly over longitudinal pavement joints, except to cross the joint perpendicularly or at an angle.

Pavement markings shall have clean and well-defined edges without running, bleeding or deformation. Markings shall be uniform in appearance, free of waviness (waviness is defined as the edge of the marking shall not vary from a straight line more than 1/4 inch in three feet or more than one inch in fifty feet for a maximum distance of 500 feet); shall be straight on tangent alignment; and shall be on a true arc on curved alignment.

The widths of pavement markings shall not deviate more than 1/4 inch on tangent nor more than 1/2 inch on curves from the required width. The length of the gap and the length of the individual stripes that form skip lines shall not deviate more than two inches from their required lengths. The length of the gap and individual skip line shall be of such uniformity throughout the entire length of each that a normal striping machine shall be able to repeat the pattern and superimpose additional striping upon the existing marking.

Glass beads and retroreflective optics shall be applied at the rate specified herein or as specified in the Department's Approved List for the specific pavement marking product. Beads and optics shall be evenly distributed over the entire lateral and longitudinal surface of the marking. The Contractor shall apply beads to the surface of liquid markings with a bead dispenser attached to the applicator that shall uniformly dispense beads simultaneously on and into the just-applied marking. The bead dispenser shall be equipped with a cut-off control synchronized with the applied marking material cut off control so that the beads are applied totally on the marking. Beads shall be applied while the liquid marking is still fluid, resulting in approximately 60% embedment in the marking's surface. Beads installed on crosswalks and stop lines on roadways with curbs only (no gutter) may be hand applied for two feet at the end of each line next to the curb with 100 percent of the beads embedded 50% to 60% into the marking's surface.

The Engineer will make a visual evaluation of the pavement marking material to assess the condition, retroreflectivity, and color after its installation and again prior to final acceptance. The Department, the Contractor, and the marking manufacturer's representative will make a further inspection if problem areas are suspected to identify specific areas of concern. If required by the Engineer, the suspect areas shall be tested by the Contractor in the presence of the Engineer in accordance with VTM-125 to define the evaluation sections and the number of measurements needed. Acceptable test results shall meet the retroreflectivity and color requirements specified in Section 246. Markings that do not meet the requirements for retroreflectivity and day and nighttime color specified in Section 246 shall be eradicated and replaced by the Contractor at no cost to the Department. Pavement markings that exhibit signs of significant tearing, deformation, shrinkage, roll back, lifting, or other signs of poor adhesion shall also be replaced by the Contractor at no cost to the Department.

**ORDER NO.: 247**  
**CONTRACT ID. NO.: CM224PMF123441B**

All costs associated with testing the marking material for retroreflectivity, color, and adhesion shall be borne by the Contractor. The Contractor will be paid for maintenance of traffic during this testing at the contract unit price for the maintenance of traffic items used.

Pavement marking manufacturer's material guarantees shall be obtained by the Contractor and assigned to the Department in writing prior to final acceptance.

- (a) **Pavement Line Markings:** Pavement markings shall be white or yellow markings (unless another color is specified in the Contract) as required by the *MUTCD* and plans for the specific location or as specified by the Engineer. Line markings shall be installed in accordance with Table VII-3 unless otherwise recommended by the manufacturer and approved by the Engineer. The Contractor shall furnish a copy of the manufacturer's installation instructions for the specific marking to the Engineer prior to installation.

The Contractor shall perform quality control testing for application thickness and glass bead rate in accordance with VTM-94 at the beginning of each workday and every 3 hours thereafter. The Contractor shall provide the apparatuses needed to perform the quality control testing in accordance with VTM-94. Compliance testing using VTM-94 shall be performed in the presence of the Engineer and shall be documented on the Pavement Marking, Contractor's Daily Log and Quality Control Report, Form C-85, immediately after testing is completed. If requested by the Engineer, the Contractor shall provide a quality control (QC) test plate and the provision of the test plate shall be documented on the Form C-85. The Contractor shall also provide a printed or electronic copy of the signed Form C-85 to the Materials Division Quality Assurance Technician for materials notebook evaluation.

The Contractor shall maintain a daily log, Form C-85, for both temporary and permanent pavement markings and markers. The C-85 form shall not be modified. All log entries shall be in electronic or legible ink format. The log shall be signed by the Contractor and delivered to the Engineer by the end of each workday. If the C-85 is in electronic format, it shall be kept current with VTM-94 testing throughout the day, and a copy signed by the Contractor (either an electronically signed copy using a secure digital signature, or a printed copy with ink signature) shall be delivered to the Engineer at the end of each workday.

Pavement line markings shall consist of solid and skip lines, including but not limited to, lane division lines, edgelines, channelizing, outlining and marking safety zones around objects, and forming islands and parking lot stalls.

1. **Type A markings** shall be applied in accordance with the manufacturer's installation instructions. When applying atop existing pavement markings, the existing marking shall first be swept or eradicated to the extent necessary to ensure that the surface of the existing marking is clean, chalk free (not powdery), and well adhered.

Glass beads for Type A, Class I markings shall be AASHTO M 247 Type 1 Beads applied at a minimum rate of 6 pounds per gallon of paint.

Retroreflective optics for Type A, Class II markings shall be applied as noted in the Department's Approved List 20 for the selected pavement marking product.

The Contractor may substitute Type A, Class I cold weather paint (traffic paint designed for application at temperatures below 40 °F) for Type A, Class I conventional paint at no additional cost to the Department. Cold weather paint shall be from the Department's Approved List 20.

2. **Type B markings** shall be applied in accordance with the manufacturers' installation instructions.

The Contractor shall furnish a properly calibrated infrared instrument to measure the actual temperature of molten thermoplastic material. Multi-component material shall be applied using internally injected guns for the proper mixing of components.



**ORDER NO.: 247**  
**CONTRACT ID. NO.: CM224PMF123441B**

Non-truck mounted equipment for application of thermoplastic material shall include an extrude die with a burner, temperature controller, agitator, and mechanical bead applicator to allow for the correct amount of material to be applied.

- a. **Thermoplastic (Class I)** material shall be applied by screed extrusion, ribbon gun, or spray equipment in accordance with the manufacturer's installation instructions. A primer/adhesive manufactured or recommended by the thermoplastic marking manufacturer shall be applied to hydraulic cement concrete surfaces and to asphalt concrete surfaces in accordance with the manufacturer's installation instructions.

Alkyd thermoplastic may be applied directly after the paving operations if the paved surface can support the equipment. Hydrocarbon thermoplastic shall not be applied to asphalt surfaces less than 30 days after paving operations are complete, hydrocarbon thermoplastic may be applied to hydraulic cement concrete surfaces as soon as permitted by the manufacturer's instructions.

Alkyd and hydrocarbon materials shall not be mixed together.

Thermoplastic shall not be applied over existing pavement markings of materials other than paint or thermoplastic, unless the existing marking is 90 percent worn away or eradicated. When applying thermoplastic over existing paint or thermoplastic, the existing marking shall first be swept or eradicated to the extent necessary to ensure that the surface of the existing marking is clean, chalk free (not powdery), and well adhered.

Thermoplastic marking material shall be applied at thickness of 90 mils ( $\pm$  5 mils) above the riding surface, whether dense or open graded surface.

Glass beads and retroreflective optics shall be surface applied at the rate of 10 pounds per 100 square feet unless specified otherwise on the Materials Division's Approved Products List 43 for the specific thermoplastic product.

- b. **Preformed thermoplastic (Class II)** material shall be installed in accordance with the manufacturer's installation instructions. A primer or sealer manufactured by or recommended by the preformed thermoplastic manufacturer shall be applied to all hydraulic cement concrete surfaces and to asphalt concrete surfaces in accordance with the manufacturer's installation instructions.

Preformed thermoplastic shall not be applied over existing pavement markings of materials other than paint or thermoplastic, unless the existing marking is 90 percent worn away or eradicated. When applying preformed thermoplastic over existing paint or thermoplastic, the existing marking shall first be swept or eradicated to the extent necessary to ensure the surface of the existing marking is clean, chalk free (not powdery), and well adhered.

Permanent transverse rumble strips shall be applied using two strips of white Type B, Class II material. The bottom strip shall be 250 mils thick and 4 inches wide, and the top strip shall be 125 mils thick and 2 inches wide (centered atop the bottom strip), unless noted otherwise in the plans. Transverse rumble strips shall be installed in arrays as per the Standard Drawings and the plans.

Preformed thermoplastic shall be 125 mils thick ( $\pm$  5 mils) unless otherwise approved by the Engineer.

Additional glass beads and retroreflective optics shall be evenly applied at a rate of 7 pounds per 100 square feet (unless another rate is specified in the Materials Division's Approved Products List 73 for the selected pavement marking product) to flood the entire surface immediately after installation while the material is molten.

- c. **Epoxy resin (Class III)** material shall be applied in accordance with the manufacturer's installation instructions and shall not be applied over existing pavement markings unless the existing marking is 90

**ORDER NO.: 247**  
**CONTRACT ID. NO.: CM224PMF123441B**

percent worn away or eradicated. Epoxy marking material shall be applied at a wet film thickness of 20 mils ( $\pm 1$  mil).

Glass beads and retroreflective optics shall be applied to the surface of the marking at the rate of 25 pounds per gallon of material, unless otherwise specified in the Materials Division's Approved Products List 75 for the specific epoxy resin product.

- d. **Plastic-backed preformed tape (Class IV)** shall be installed in accordance with the manufacturer's installation instructions. Tape may be applied to asphalt concrete and hydraulic cement concrete pavements. Tape may be installed immediately following the final rolling of new asphalt concrete surface provided installation is done in strict conformance with the preformed tape manufacturer's instructions for this type of application. Tape shall not be applied over existing pavement markings of other materials unless the existing marking is 90 percent worn away or eradicated.

Primer/adhesive shall be used to enhance adhesion in accordance with the manufacturers' installation instructions, except when tape is inlaid immediately following the final rolling of the new asphalt concrete surface.

Tape for pavement line markings shall be applied by an application cart as recommended by the manufacturer. Tape shall be tamped into place with a tamper cart with a weight as recommended by the manufacturer. Vehicle wheels may be used to tamp line markings if allowed by the manufacturer's installation instructions. If vehicle wheels are used to tamp the markings, the Contractor shall ensure that the vehicle tires ride true down the length of the tape marking.

- e. **Patterned preformed tape (Class VI)** shall be installed either under the guidance of the manufacturer's representative or by a manufacturer's certified technician.

Type B, Class VI markings applied to new plant mix asphalt surfaces shall be installed as per manufacturer's installation instructions, except that non-embedded (adhesive) surface application will not be permitted; the markings shall be inlaid in the freshly installed asphalt surface before the pavement mat has cooled. The temperature of the asphalt mat shall be between 100 and 180 degrees. The Type B, Class VI markings shall be inlaid with a roller (minimum 2 tons) operating in a non-vibratory mode when the asphalt mat is between 100 and 180 degrees.

The Contractor shall ensure that markings are not degraded by subsequent operations. Markings that are improperly inlaid during the pavement operations shall be completely eradicated and reapplied via non-embedded surface application at the Contractor's expense.

Surface-applied Type B Class VI markings shall not be installed directly over existing markings, except that Type B Class VI markings may be installed over Type A markings that are fully dry and are at a thickness of 10 mils or less.

The Contractor shall install Type B, Class VI markings on existing asphalt concrete roadway surfaces, hydraulic cement concrete surfaces, and existing or new surface treatment, slurry seal, and latex emulsion surfaces in accordance with the manufacturer's installation instructions for pavement surface preparation, sweeping, and installation techniques for non-embedded (adhesive) surface applications and splicing. When installed on Latex Emulsion or other Surface Treatment surfaces, the Contractor shall select a product from the Department's Approved List 17 which is warranted by the manufacturer against failure resulting from improper installation and material defects when used on that type of surface, and a low-VOC surface preparation primer adhesive shall be applied prior to application of the Type B, Class VI markings.

Prior to surface application of Type B, Class VI markings:

**ORDER NO.: 247**  
**CONTRACT ID. NO.: CM224PMF123441B**

- The surface shall be swept clear of all loose aggregate immediately before spraying the surface preparation primer adhesive, and
- The primer adhesive shall be sprayed uniformly at the correct thickness (shall not exceed the maximum thickness specified by the manufacturer), and the primer adhesive shall be cured in accordance with the manufacturer's installation instructions.

After application of the surface preparation primer adhesive, the tape shall be tamped to the road using a 200 pound minimum tamper cart and vehicle wheels. The Contractor shall ensure that the vehicle tires, if used, ride true down the length of the tape marking and in accordance with manufacturer instructions.

- f. **Polyurea (Class VII)** shall be applied in accordance with the manufacturer's installation instructions. Polyurea marking material shall not be applied over existing pavement markings unless the existing marking is 90 percent worn away or eradicated; or over Type A markings that are fully dry and are at a thickness of 10 mils or less.

Polyurea marking material shall be applied at a wet film thickness of 20 mils ( $\pm 1$  mil). Glass beads and retroreflective optics shall be applied at the rate specified in the VDOT Materials Division's Approved Products List 74 for the specific polyurea product.

3. **Type D and E temporary pavement markings** shall be installed in accordance with the manufacturers' installation instructions and will be paid for in accordance with Section 512.

- (b) **Pavement message and symbols markings** shall be the color required by the *MUTCD* or the plans for the specific location or as specified by the Engineer. The Contractor shall install message and symbols markings in accordance with Table VII-3, unless otherwise recommended in the manufacturers' installation instructions and approved by the Engineer.

Surface temperature at time of application shall be in accordance with manufacturer's installation instructions. If the installation instructions do not specify minimum surface temperature, then the markings shall not be installed unless the surface temperature at time of application is 50°F or higher. Surface temperature requirements shall not be considered met if the temperature is forecasted to drop below the minimum within two hours of application. The Contractor may heat the pavement for a short duration to dry the pavement surface and bring the surface temperature to within the allowable temperatures for pavement marking installation, at no extra cost to the Department. Heat torch temperatures shall not exceed 300°F. The Contractor shall monitor pavement temperature to ensure it does not rise above 120°F at any time. Any damage to the pavement shall be promptly repaired at no extra cost to the Department.

Message and symbol markings include, but shall not be limited to, those detailed in Standard Drawing PM-10.

The sizes and shapes of symbols and characters shall match the size and shape specified in Standard Drawing PM-10 or elsewhere in the Contract. Hand-drawn or "stick" symbols or characters will not be allowed.

**ORDER NO.: 247**  
**CONTRACT ID. NO.: CM224PMF123441B**

**TABLE VII-3**  
**Pavement Markings**

Type	Class	Name	Film Thickness (mils)	Pavement Surface	Application Limitations	Appr. List No.
A	I	Conventional or Cold-Weather Traffic Paint	15 ± 1 when wet	AC HCC	May be applied directly after paving operations	20
A	II	High Build Traffic Paint	25 ± 2 when wet	AC HCC	May be applied directly after paving operations	20
B	I	Thermoplastic Alkyd	90 ± 5	AC HCC	May be applied directly after paving operations	43
	I	Thermoplastic Hydrocarbon	90 ± 5 when dry	AC HCC	Do not apply less than 30 days after paving operations	43
	II	Preformed Thermoplastic	120-130	AC HCC	Manufacturers installation instructions	73
	III	Epoxy resin	20 ± 1 when wet	AC HCC	Manufacturers installation instructions	75
	IV	Plastic-backed preformed Tape	60 - 120	AC HCC	Manufacturer's installation instructions	17
	VI	Patterned preformed Tape	20 min <sup>1</sup> 65 min <sup>2</sup>	AC HCC	(Note 4)	17
	VII	Polyurea	20 ± 1	AC HCC	Manufacturer's installation instructions	74
D	III	Wet Reflective Removable tape	(Note 3)	AC HCC	Temporary pavement marking	17
E		Removable black tape (Non-Reflective)	(Note 3)	AC	Temporary pavement marking for covering existing markings	17

<sup>1</sup>Thinnest portion of the tape's cross section.

<sup>2</sup>Thickest portion of the tape's cross section.

<sup>3</sup>In accordance with manufacturer's installation instructions.

<sup>4</sup>In accordance with the manufacturer's installation instructions, except that Type B, Class VI markings on new plant mix asphalt surfaces shall be inlaid into the freshly installed asphalt surface and not surface-applied.

- (c) **Eradication:** Eradication of existing pavement markings shall be in accordance with Section 512 except only 90 percent removal is required where the new markings will completely cover existing markings.
- (d) **Pavement markers:** Retroreflectors for pavement markers shall conform to Section 235. The front side shall be the same color as the adjacent pavement marking. The back side of the shall be red for one-way markers, and the same color as the adjacement pavement marking for two-way markers.

Permanent markers shall not be installed until after the installation of the corresponding permanent line marking unless approved by the Engineer. If permanent markers are installed before installation of the corresponding permanent marking, then the Contractor shall ensure that the retroreflector is not damaged or obscured during the subsequent line marking installation.

- Inlaid Pavement Markers** shall be installed as per Standard Drawing PM-8.

The Contractor shall not install markers on existing bridge decks. Inlaid Pavement Markers shall be installed on new bridge decks where required by the Plans.

**ORDER NO.: 247**  
**CONTRACT ID. NO.: CM224PMF123441B**

Inlaid Pavement Markers shall be placed in relation to pavement joints and cracks as follows:

- In existing Asphalt Concrete pavement, new or existing Hydraulic Cement Concrete pavement, and bridge decks, the edge of the Inlaid Pavement Marker groove shall be at least 2 inches from pavement joints and cracks, ensuring that the finished line of markers is straight in accordance with the tolerance for pavement markings specified in Section 704.03 of the Specifications. Offset from the longitudinal joint shall take precedence over straightness of the line of markers.
- In new Hydraulic Cement Concrete pavement or when installed in conjunction with new latex modified microsurfacing or slurry seal treatments, the edge of the Inlaid Pavement Marker groove shall be at least 2 inches from all longitudinal and transverse surface course pavement joints and 1 inch maximum off alignment from the corresponding pavement marking line. The finished line of markers shall be straight in accordance with the tolerance for pavement markings specified in Section 704.03 of the Specifications. Straightness of the line of markers and alignment with the corresponding pavement marking line takes precedence over offset from the surface course joint.

Retroreflectors shall be affixed to holders, using an adhesive from the Department's Approved List 22 (Inlaid Pavement Markers) prior to installation.

Tapered grooves and plunge cuts shall be cut using diamond blades that can accurately control the groove dimensions, resulting in smooth uniform tapers and smooth groove bottoms and ensuring the pavement does not tear or ravel. The Contractor shall remove all dirt, grease, oil, loose or unsound layers, and any other material from the groove which would reduce the bond of the adhesive. Pavement surfaces shall be maintained in a clean and dry condition until the marker is placed.

Holders shall be installed in the same shift as grooving.

The epoxy adhesive shall be thoroughly mixed until it is uniform in color, and applied in accordance with the manufacturer's installation instructions. The Contractor shall partially fill the plunge cut with sufficient epoxy adhesive such that the epoxy adhesive bed area is equal to the bottom area of the holder. The Contractor shall then set the holder in the epoxy adhesive such that the breakaway tabs are resting on the road surface, the holder is centered in the cut, and then fill in additional epoxy adhesive if necessary so the entire perimeter of the holder is completely surrounded in epoxy, with the epoxy level with the edge of the holder in accordance with the manufacturer instructions.

The Contractor shall remove all adhesive and foreign matter from the face of the retroreflector or replace the retroreflector if adhesive and foreign matter cannot be removed. The marker shall be replaced if it is not properly positioned and adhered in the plunge cut.

2. **Nonplowable raised pavement markers** shall be bonded to the surface in accordance with the manufacturer's installation instructions. The bonding material shall be from the Department's Approved List 22 for the specific marker.

- (e) **Maximum Allowable Time Limits for Unmarked Roads:** Existing markings that are obscured, covered, or eradicated by resurfacing operations (including existing symbol and message markings where the need for temporary symbol or message markings has been identified in the Contract) shall be replaced with either temporary or permanent markings within the time limits established in Table VII-4, except as noted herein.

**ORDER NO.: 247**  
**CONTRACT ID. NO.: CM224PMF123441B**

If the Contractor begins the next lift within the time limits specified in Table VII-4 for a non-final surface, then the time limits shall be recalculated as starting at the end of the work day from the time of that next resurfacing operation.

The Engineer may allow the extension of the time limits by up to 12 hours for 10,000 ADT or greater roads, up to 24 hours for 9,999 to 3,000 ADT roads, and up to 48 hours for less than 3,000 ADT roads, provided that all of the following apply:

- The road is non-limited access.
- The road has a posted or statutory speed limit of 40 mph or below.
- All lanes are delineated by the milled surface or asphalt overlay.
- The Engineer determines that there is not significantly deficient sight distance.
- “Unmarked Pavement Ahead” or “No Center Line” warning signs were properly installed in accordance with the VWAPM when the unmarked lane was opened to traffic.

For final surfaces, the Contractor shall determine if the permanent markings can be installed within these time limits, based on the installation requirements for that permanent marking material on that type of surface, and the weather conditions. If the permanent markings will not be installed within these time limits, then temporary markings shall be installed.

Temporary markings are not required on roads that are unmarked in the permanent condition.

**Table VII-4 – Time Limits for Unmarked Roads:**

Road type	lane lines, center lines, edge lines, and gore lines	Symbols, messages, and transverse lines
<b>Interstates and limited access highways, including ramps</b>	<p>Shall be temporarily or permanently marked <b>before opening the road to traffic.</b></p> <p>On Latex Microsurfacing surfaces, if the surface has not cured enough to hold the temporary markings (weathered-in texture), then the Contractor shall apply the temporary paint before opening the lane to traffic and then shall refresh the temporary markings as necessary as per Section 512.03(k).</p>	<p>If the Contract Documents indicate such markings are required to be temporarily marked, they shall be installed <b>within 24 hours</b> after the end of the workday when the corresponding existing markings were obscured, removed, or eradicated.</p>
<b>Non-limited access roads (speed limit ≥ 35 mph and ADT ≥ 10,000) (See Note)</b>	<p>Shall be temporarily or permanently marked within <b>24 hours</b> after the end of the workday when the corresponding existing markings were obscured, removed, or eradicated.</p>	<p>If the Contract Documents indicate such markings are required to be temporarily marked, they shall be installed <b>within 72 hours</b> after the end of the workday when the corresponding existing markings were obscured, removed, or eradicated.</p>

**ORDER NO.: 247**  
**CONTRACT ID. NO.: CM224PMF123441B**

<b>Non-limited access roads (speed limit <math>\geq</math> 35 mph and ADT of 3,000-9,999) (See Note)</b>	Shall be temporarily or permanently marked within <b>48 hours</b> after the end of the workday when the corresponding existing markings were obscured, removed, or eradicated.	If the Contract Documents indicate such markings are required to be temporarily marked, they shall be installed <b>within 96 hours</b> after the end of the workday when the corresponding existing markings were obscured, removed, or eradicated.
<b>Non-limited access roads (speed limit <math>\geq</math> 35 mph and ADT of 1,000-2,999)</b>	Shall be temporarily or permanently marked within <b>72 hours</b> after the end of the workday when the corresponding existing markings were obscured, removed, or eradicated.	
<b>Non-limited access roads with speed limit <math>&lt;</math> 35 mph or ADT <math>&lt;</math> 1,000</b>	Temporary markings are not required.  If the road will have permanent markings, then "Unmarked Pavement Ahead" or "No Center Line" temporary signs shall be installed as per the VWAPM before reopening the travel lanes to traffic.	Temporary symbol/message/transverse line markings are not required.

NOTE: If an approach to a signalized intersection has (a) two or more approach through lanes, (b)  $\geq$  45 mph speed limit, (c) greater than 3000 ADT, and (d) all markings on the approach are obliterated, then all lane lines and centerlines within 250 feet of the location of the stop line location shall be temporarily or permanently marked within **24 hours** of opening the approach to traffic, unless a time extension is approved by the Engineer and "Unmarked Pavement Ahead" or "No Center Line" warning signs were properly installed as per the VWAPM when the unmarked approach was first opened to traffic.

- (f) **Temporary Pavement Markings:** Premarking, dotting or layout marking shall not be used as a substitute for temporary pavement marking.

Temporary linear, symbol, and message pavement markings specified in the Contract shall be installed at the same locations that the permanent pavement markings are to be installed, unless otherwise approved by the Engineer.

Temporary lane lines, centerlines, and edge lines may be marked with Type D removable tape, Type A-temporary paint, or FTPMs. All temporary symbol and message markings and other types of temporary markings may be marked with Type D-removable tape or Type A-temporary paint.

**ORDER NO.: 247**  
**CONTRACT ID. NO.: CM224PMF123441B**

Type A, Class I paint used for temporary pavement markings shall be installed in accordance with the manufacturer's installation instructions and as detailed in the following table:

	<b>Milled Surface</b>	<b>Intermediate Lifts or Final Surface (See Note 1)</b>
<b>Thickness</b>	15 ± 1 mils when wet	8 to 10 mils when wet
<b>Glass Bead Application Rate</b>	6 lbs. minimum of glass beads per gallon of material	3 lbs. of glass beads per gallon of material for 8 to 10 mils and 6 lbs. per gallon for 11 to 15 mils (See Note 2)
<b>Long Line Width</b>	Same width as the permanent markings	
<b>Skip Line Pattern</b>	10-foot line segments / 30-foot gaps (approx.)	10-foot line segments / 30-foot gaps (approx.)

<sup>1</sup>Placing the paint at a greater thickness (in order to avoid re-striping in cases of longer duration) is allowable, provided that no more than 10 mils thickness remains at the time the permanent marking is placed. If the temporary paint is too thick to support proper application of the permanent markings, then the Engineer may require partial eradication of the temporary markings at the Contractor's expense prior to permanent marking eradication.

<sup>2</sup>Where the permanent marking is 6 inches or greater in width, the temporary Type A, Class I pavement markings on the intermediate lift or final surface shall be 75% the width of the permanent marking. Where the permanent marking is 4 inches in width, the temporary Type A, Class I pavement markings on the intermediate lift or final surface shall also be 4 inches.

Temporary Type A, Class I pavement markings on final surfaces shall be arranged and spaced so that they will be completely covered by the subsequent installation of permanent pavement markings atop those temporary paint markings.

Temporary passing zone changes shall be at the same location as the permanent marking passing zone change locations.

Temporary stop lines, when required by the Contract, shall be 12 inches wide unless otherwise directed.

Temporary crosswalks, when required by the Contract, shall be two parallel 6-inch white lines unless otherwise directed.

The moisture test in VTM 94 is not required for temporary pavement marking. However, if the VTM 94 moisture test is not performed, the Contractor shall document the approximate surface wetness on the Form C-85.

If the surface is visibly dry (does not have puddling or free-standing water present), the Contractor is responsible for installing and maintaining the temporary pavement markings. If the Contractor opts not to perform VTM 94 and the temporary markings applied to a visibly dry surface do not sufficiently adhere to the surface, temporary pavement markings shall be reapplied at no additional cost to the Department.

If the surface has puddling or free-standing water present, or if a VTM 94 moisture test result indicates that the condition of the surface is not suitable for temporary pavement marking application, the Engineer may direct the Contractor to install temporary pavement markings on the surface in order to avoid having traffic operate on an unmarked road. In such circumstances the Department may direct the Contractor to install one subsequent reapplication of the temporary markings once the surface has dried, if the previous installation did not satisfactorily adhere to the road. In such circumstances the Contractor will be compensated at the Contract bid price for those temporary markings.



**ORDER NO.: 247**  
**CONTRACT ID. NO.: CM224PMF123441B**

In order to quicken the paint drying process, the Contractor may spray an Engineer-approved drying agent into the traffic paint during installation in accordance with the manufacturer's installation instructions, at no additional cost to the Department.

While in place, temporary pavement markings shall be maintained at adequate visibility and retroreflectivity, as defined in Section 512, until the permanent markings are installed. No additional application (refreshing) is required as long as the temporary markings continue to meet these requirements.

If Type D-removable tape fails the visual evaluation or is deficient in any other respect before the installation of permanent markings, the tape shall be removed and new temporary markings shall be applied at no additional cost to the Department.

If Type A temporary paint does not meet the requirements of Section 512 before the installation of permanent markings, such temporary markings shall be refreshed by the application of a lighter application (applied so as to enhance visibility but not as to require eradication before application of permanent markings) of Type A-temporary markings at the Contractor's expense.

Permanent pavement markings shall not be installed atop Type A temporary markings if the paint is not fully dry . If the temporary paint is not located directly underneath the location where the permanent markings are to be installed, they shall be 100% eradicated in accordance with Section 512 before installation of permanent markings at no additional cost to the Department.

**(g) Time Limits for Permanent Pavement Marking and Marker Application**

All permanent linear, message, and symbol markings and markers shall be completed within the time limits described in Table VII-5 below. These time limits begin on the last workday (final surface) of continuous paving for that section of roadway, except that for Standard RS-3, RS-4, RS-8, and RS-9 rumble stripe markings these time limits begin on the last workday of rumble strip installation.

**ORDER NO.: 247**  
**CONTRACT ID. NO.: CM224PMF123441B**

**Table VII-5 Time Limits for Permanent Pavement Marking and Marker Application**

Road type	Marking/marker type	Time Limit (see note 2)
<b>Interstates and other limited access highways (including ramps)</b>	Type B, Class VI markings	See Note 1
	Liquid longitudinal markings	Within 30 days
	Symbol, message, gore area chevron, and transverse line markings	Within 30 days
	Markers	Within 45 days
<b>Non-limited access primaries with <math>\geq 10,000</math> ADT or speed limit <math>\geq 45</math> mph</b>	Type B, Class VI markings	See Note 1
	Liquid longitudinal markings	Within 30 days
	Symbol, message, gore area chevron, and transverse line markings	Within 30 days
	Markers	Within 60 days
<b>All other roads</b>	Type B, class VI markings	See Note 1
	Liquid longitudinal markings	Within 30 days
	Symbol, message, gore area chevron, and transverse line markings	Within 45 days
	Markers	Within 60 days

**Notes**

- (1) Type B, Class VI longitudinal markings on Plant Mix surfaces shall be inlaid on the same day the final surface is placed as specified herein. Type B, Class VI longitudinal markings on Latex Microsurfacing, Slurry Seal, and Surface Treatment operations shall be placed between 14 and 30 days after the last workday of continuous paving on that section of roadway.
- (2) Except as indicated in Note (1) the time limit commences for a continuous section at the end of the last workday that the final surface is placed. For roads with more than two lanes, each direction will be considered a separate continuous section.

Permanent markings shall not be installed where pavement curing time or weather conditions prohibit installation, or where the pavement surface does not meet the markings manufacturer's requirements (e.g. the aggregate is not worn-in at the edges).

Any necessary refreshing or replacement of temporary pavement markings or FTPMs will not affect the allowable time limit for completion of permanent pavement marking installation.

**704.04 – Measurement and Payment**

**Pavement line markings** will be measured in feet and paid for at the Contract foot price for the type, class and width specified. This price shall include furnishing and installing the pavement marking material, surface preparation, premarking, documentation and staking of existing markings, quality control tests, daily log, guarding devices, primer, adhesive, glass beads, and manufacturer's warranty.

**Contrast Pavement Line Marking** will be measured in linear feet and will be paid for at the Contract unit price per linear foot for the type or class and width specified. This price shall include surface preparation, premarking, furnishing, installing, quality control tests, daily log, guarding devices, primer or adhesive, glass beads, reflective optics materials when required, and warranty.

**Pavement message markings** will be measured in units of each per location or in linear feet as applicable for the message, type, class material, and size specified, and will be paid for at the Contract unit price per each or linear foot. This price shall include surface preparation, premarking, furnishing, installing, quality

**ORDER NO.: 247**  
**CONTRACT ID. NO.: CM224PMF123441B**

control tests, daily log, guarding devices, primer or adhesive, glass beads, reflective optics materials when required, and warranty.

**Pavement symbol markings** will be measured in units of each per location for the symbol, type, and class of material specified, and will be paid for at the Contract unit price per each. This price shall include surface preparation, premarking, furnishing, installing, quality control tests, daily log, guarding devices, primer or adhesive, glass beads, reflective optics materials when required, and warranty.

**Temporary pavement line markings** will be measured in feet and paid for at the Contract foot price for the type, class, and width specified. This price shall include furnishing, installing, and maintaining the pavement marking materials; surface preparation, inspections, testing, daily log, and guarding devices; providing primer, adhesive, glass beads, and drying agents; and disposal, and removing removable markings when no longer required.

If temporary line markings require refreshing, reapplication, or replacement before the final surface or the permanent markings are installed, all cost for refreshing, reapplication, or replacement shall be at the Contractor's expense, unless the Contractor was directed by the Engineer to apply the temporary markings to a visibly wet surface or to an insufficiently cured latex emulsion, slurry seal, or surface treatment surface.

If the Contractor uses FTPMs to simulate the temporary pavement marking, they will be measured in linear feet and paid for at the linear foot price for the temporary marking material being simulated. That measurement shall represent all FTPMs required for that simulated line marking. No additional payment will be made if the Contractor elects to remove FTPMs and install other temporary pavement markings. This cost shall include furnishing, installing and maintaining the FTPMs, removable covers, surface preparation, quality control tests, daily log, guarding devices, removal, and disposal.

**Temporary pavement message (word) markings** will be measured in units of each and paid for at the Contract each price for the character size, type, and class specified. This price shall include furnishing, installing, and maintaining the pavement marking materials; surface preparation, inspections, testing, daily log, and guarding devices; providing primer or adhesive, glass beads, and drying agents; and disposal, and removing removable markings when no longer required.

**Temporary pavement symbol markings** will be measured in units of each and paid for at the Contract each price for the size, type, and class specified. This price shall include furnishing, installing, and maintaining the pavement marking materials; surface preparation, inspections, testing, daily log, and guarding devices; providing primer or adhesive, glass beads, and drying agents; and disposal, and removing removable markings when no longer required.

If temporary pavement line, message, or symbol markings require refreshing, reapplication, or replacement before the final surface or the permanent markings are installed, all cost for refreshing, reapplication, or replacement (including Maintenance of Traffic costs) shall be at the Contractor's expense unless the Contractor was directed by the Engineer to apply the temporary markings to a visibly wet surface or to an insufficiently cured latex emulsion, slurry seal, or surface treatment surface.

**Pavement markers** will be measured in units of each for the marker type and pavement type specified and will be paid for at the contract unit price per each. This price shall include surface preparation, furnishing, installing, prismatic retroreflectors, pavement cutting, adhesive, holders, quality control tests, and daily log.

**Eradication of pavement markings** will be measured and paid for in accordance with Section 512.

**ORDER NO.: 247**  
**CONTRACT ID. NO.: CM224PMF123441B**

Payment will be made under:

<b>Pay Item</b>	<b>Pay Unit</b>
(Type and class) Pavement line marking (width)	Linear Foot
(Type and Class) Contrast Pavement Line Marking (width)	Linear Foot
Pavement message marking (Message, Type and Class Material, size character)	Each or Linear Foot
Pavement symbol marking (Symbol, Type and class material)	Each
(Type) Pavement marker (type pavement)	Each
(Type and class) Temporary pavement line marking (width)	Linear Foot
Temporary pavement message (word) marking (size character, type and class material)	Each
Temporary pavement symbol marking (Symbol, Type and class material)	Each

**ORDER NO.: 247**  
**CONTRACT ID. NO.: CM224PMF123441B**

[SP704-000120-00](#)

VIRGINIA DEPARTMENT OF TRANSPORTATION  
SPECIAL PROVISION FOR  
**INLAID PAVEMENT MARKERS**

August 26, 2019

**I. Description**

This work shall consist of furnishing and installing inlaid pavement markers in accordance with the Contract and manufacturer's installation instructions. Snow-plowable raised pavement markers conforming to Section 704.03(d)1 of the Specifications shall not be used in the Work.

**II. Materials**

1. **All components** of the inlaid pavement marker shall be listed on the Department's Approved List 22.
2. **Retroreflectors** shall conform to ASTM D4383. The color and directional properties (one-way or two-way) of retroreflector lenses shall conform to Standard Drawing PM-8.
3.  **Holders** shall be made of polycarbonate plastic that are nominally 4.75 inches wide (excluding breakaway tabs), can hold retroreflectors from the Department's Approved List 22 under Inlaid Pavement Markers, comes with two breakaway positioning tabs, and will hold the retroreflector just below the pavement surface when installed with the breakaway positioning tabs resting on the pavement surface.

**III. Procedure**

The Contractor shall furnish the manufacturer's recommendations for adhesives and installation procedures to the Department before installing the markers.

**1. Location and Spacing**

The Contractor shall not install markers on bridge decks.

The edge of the groove shall be at least 2 inches from pavement joints and cracks, ensuring that the finished line of markers is straight in accordance with the tolerance for pavement markings specified in Section 704.03 of the Specifications. Offset from the longitudinal joint shall take precedence over straightness of the line of markers.

**2. Installation**

Retroreflectors shall be affixed to holders, using an adhesive from the Department's Approved List 22 (Inlaid Pavement Markers) prior to installation.

The Contractor shall cut tapered grooves and plunge cuts into the concrete or final course of asphalt. Grooves and plunge cuts shall be at the dimensions specified in Figure 1, unless specified otherwise in the manufacturer's installation instructions. The groove length may be shortened to 54 inches on sharp curves if approved by the Engineer.

Tapered grooves and plunge cuts shall be cut using diamond blades that can accurately control the groove dimensions, resulting in smooth uniform tapers and smooth groove bottoms and ensuring the pavement does not tear or ravel. The Contractor shall remove all dirt, grease, oil, loose or unsound layers, and any other material from the groove which would reduce the bond of

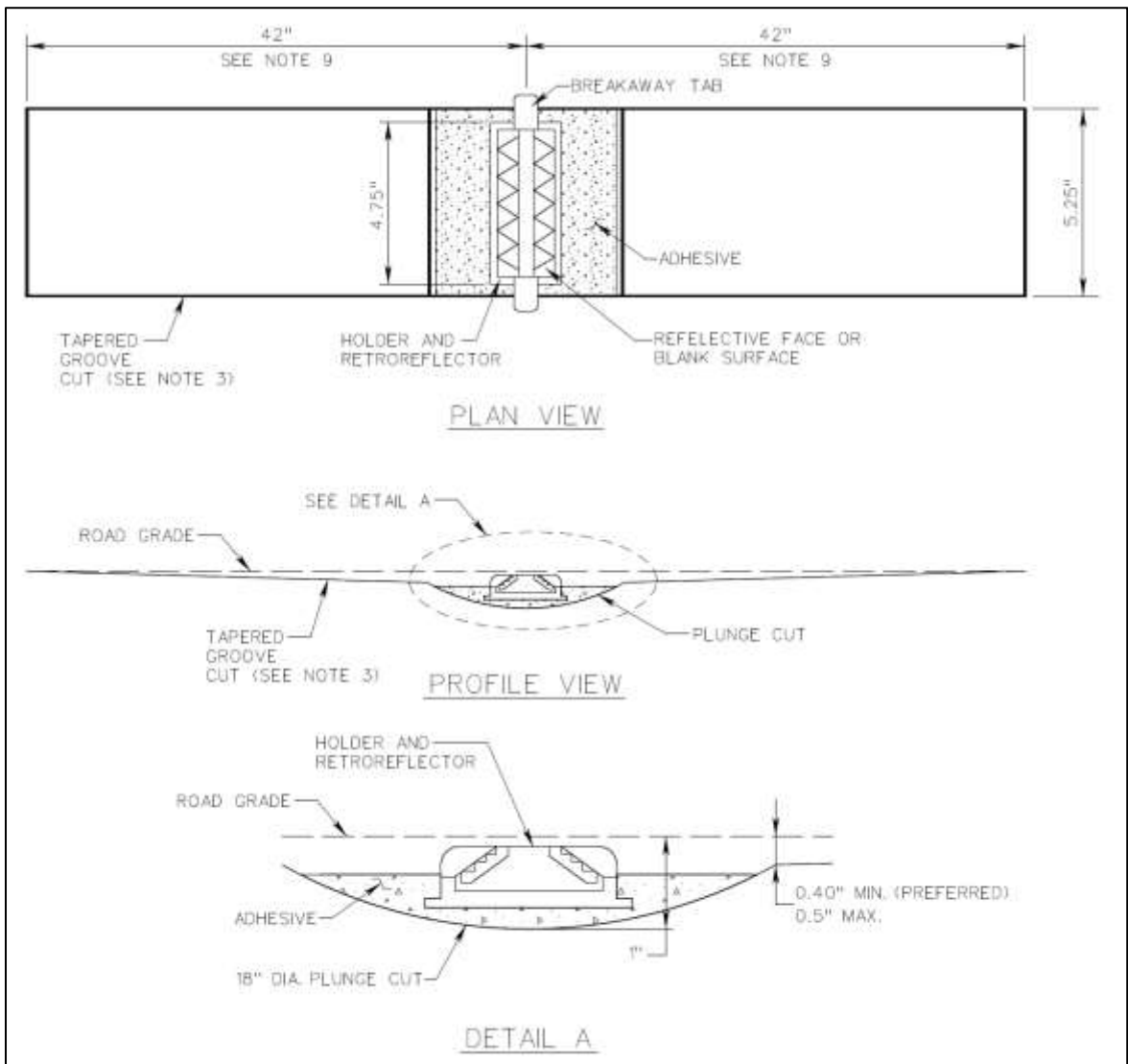
**ORDER NO.: 247**  
**CONTRACT ID. NO.: CM224PMF123441B**

the adhesive. Pavement surfaces shall be maintained in a clean and dry condition until the marker is placed.

Holders shall be installed in the same shift as grooving.

The epoxy adhesive shall be thoroughly mixed until it is uniform in color, and applied in accordance with the manufacturer's installation instructions. The Contractor shall partially fill the plunge cut with sufficient epoxy adhesive such that the epoxy adhesive bed area is equal to the bottom area of the holder. The Contractor shall then set the holder in the epoxy adhesive such that the breakaway tabs are resting on the road surface, the holder is centered in the cut, and then fill in additional epoxy adhesive if necessary so the entire perimeter of the holder is completely surrounded in epoxy, with the epoxy level with the edge of the holder in accordance with the manufacturer instructions.

The Contractor shall remove all adhesive and foreign matter from the face of the retroreflector or replace the retroreflector if adhesive and foreign matter cannot be removed. The marker shall be replaced if it is not properly positioned and adhered in the plunge cut.



**Figure 1: Installation of Inlaid Pavement Marker**

**ORDER NO.: 247**  
**CONTRACT ID. NO.: CM224PMF123441B**

**IV. Measurement and Payment**

**Inlaid Pavement Marker** will be measured in units of each and will be paid for at the Contract each price. This price shall include surface preparation, furnishing, installing, retroreflectors, pavement cutting, adhesives, and holder.

Payment will be made under:

<b>Pay Item</b>	<b>Pay Unit</b>
Inlaid Pavement Marker (type pavement)	Each

**ORDER NO.: 247**  
**CONTRACT ID. NO.: CM224PMF123441B**

**SP801-000100-01**

VIRGINIA DEPARTMENT OF TRANSPORTATION  
SPECIAL PROVISION FOR  
**LANE CLOSURE COORDINATION (LCC)/LANE CLOSURE IMPLEMENTATION (LCI)**

September 20, 2017

**I. General Requirements**

This work shall consist of coordinating and communicating lane closure operations through the local Transportation Operations Centers (TOC's). The Contractor shall coordinate lane closures in accordance with this Special Provision, and only implement lane closures with approval from the Department.

**II. Training**

The Contractor shall have individuals trained to input work-zone information into the Department's LCC/LCI system, currently LCAMS and VaTraffic, on a weekly basis and to update as needed. These individuals shall be able to speak, understand, read, and write English, and be able to operate a computer. No advanced computer skills are needed to use the LCAMS or VaTraffic systems. The Contractor shall have a computer with internet connectivity and email capability.

The Contractor shall contact the Regional TOC Work Zone Lane Closure (LCAMS/VaTraffic) Coordinator to initiate system access and schedule training, when necessary. The Department requires a 10 business-day notice to schedule classroom training for LCAMS. The Contractor's designated individuals shall complete the courses Introduction to VaTraffic, VaTraffic Reports, VaTraffic Planned Events, and VaTraffic Work Zones. LCAMS and VaTraffic training for the individuals shall be completed prior to the Notice to Proceed date.

**III. Lane Closure Process**

1. **Lane Closure Coordination Process.** All lane closures shall be entered as precisely as possible into the Lane Closure Advisory Management System (LCAMS) and VaTraffic no later than 8 AM on Thursday of the week prior to the planned lane closure, and updated as needed. For the purposes of this Special Provision, a week starts on Sunday. If this submission deadline changes (e.g., for weeks involving a holiday), the Engineer will notify the Contractor at least one week in advance. Final approval for the lane closure will be issued by the Engineer. All fields in LCAMS and VaTraffic must be properly filled out.

A. **Point of Contact.** The data fields labeled "Requesting Org POC" in LCAMS and "Point of Contact" in VaTraffic shall contain the name and email address of the person physically entering the request into LCAMS.

B. **Conflict Resolution.** LCAMS will identify and flag most conflicts, and will automatically assign priority as first-come, first-serve. The Contractor has the right to contact the higher-priority party and attempt resolution with them, provided the Contractor submits the final resolution to the Engineer no later than 5 PM on Thursday of the week prior to the planned lane closure. The Engineer will handle all unresolved conflicts between requests and other events according to the priorities listed below, with the highest priority item first. If some or all requests involved in the conflict are the same priority level, conflict resolution will be on a first-come, first-serve basis.

(1) **Emergency Work.** Work that if not done "will result" in damage to a motorist vehicle or infrastructure, or danger to public health and safety.



**ORDER NO.: 247**  
**CONTRACT ID. NO.: CM224PMF123441B**

- (2) **Lower Priority Items Previously Delayed.** Work that while considered a lower priority, if perpetually delayed could result in severe consequences.
  - (3) **Urgent Work.** Work that if not done “may result” in damage to the motorist vehicle or infrastructure, or danger to public health and safety.
  - (4) **Contractual Obligated Work.** Work that is expected to be accomplished “on-time, on-budget”.
  - (5) **Weather Dependent Work.** Work that is dependent on the temperature and clear or dry conditions.
  - (6) **Routine Maintenance Work.** Work that is routine in nature that can be rescheduled and moved around, within limits, without undue risk.
- C. The request shall be supported by the Schedule of Record, and the Engineer may deny requests which are not. The Contractor will be allowed to request lane closures to accommodate potential weather delays.
- D. The Contractor may revise his entries in LCAMS and VaTraffic after the Thursday deadline subject to the approval of the Engineer and the conflict resolution requirements herein.
2. **Lane Closure Implementation Process.** The Contractor shall notify the Regional TOC no later than 15 minutes, but no earlier than 45 minutes, prior to installing the lane closure, or no later than 15 minutes prior to scheduled start time if lane closure is delayed or canceled. The Contractor shall notify the TOC and update VaTraffic of any changes in lane-closure impact during the execution of work. The Contractor shall notify the Regional TOC no later than 15 minutes after the lane is reopened to traffic.
3. **Emergency Lane Closure.** If an Emergency Lane Closure is required, the Contractor shall coordinate directly with the TOC regarding the lane closure as soon as the location and size of the lane closure is known. An Emergency Lane Closure is defined as road work which could not have been anticipated and is required to protect the public from immediate, severe harm, and has a priority as defined by Section III-1B(1).

**IV. Measurement and Payment**

Lane closure coordination will not be measured or paid for separately, but the cost thereof shall be included in the price of other items.

**ORDER NO.: 247**  
**CONTRACT ID. NO.: CM224PMF123441B**

VIRGINIA DEPARTMENT OF TRANSPORTATION  
SPECIAL PROVISION FOR  
**PUBLIC NOTIFICATION OF PARKING RESTRICTIONS**  
**(Plant Mix)**

August 18, 2015; Reissued July 12, 2016\_

The Contractor shall be responsible for notifying the public of parking restrictions due to the resurfacing operations scheduled in this contract by distributing door-hangers and erecting “No Parking” signs throughout the subdivision streets affected as follows:

- A template for printing door-hangers will be provided to the Contractor by the Department. The Contractor shall make all necessary arrangements to furnish and distribute the printed door-hangers to homes no more than thirty (30) days prior to commencement of work and no less than three (3) days in the affected areas.
- A template for furnishing “No Parking” signs will be provided to the Contractor by the Department. The Contractor shall make all necessary arrangements for furnishing and placing the “No Parking” signs, including posts, for affected homes no more than three (3) working days prior to commencement of work. “No Parking” Signs shall be placed a minimum of 36” off the ground and shall clearly be visible to the public. The Contractor shall install the sign posts using posts of their choosing so long as the “No Parking” Sign is securely mounted and does not result in warping of the sign. The Contractor shall notify the appropriate police department after signs are installed and prior to commencement of work. If the commencement of work date follows a holiday or weekend, the three (3) working day prior notification requirement shall be in addition to the weekend or holiday. The period of operations, as designated on the “No Parking” signs, shall not exceed fourteen (14) consecutive calendar days.

The Contractor shall visually inspect the construction site each day after the placement of “No Parking” signs to ensure they are still in place. Any damaged or missing signs shall be promptly replaced at the Contractors expense.

All “No Parking” signs shall be removed and disposed of by the Contractor upon completion of the work.

The cost of furnishing and distributing door-hangers, furnishing, installing, maintaining, and removing “No Parking” signs and posts shall be borne by the Contractor at no cost to the Department. Door Hangers and No Parking Signs shall be produced in color and laminated prior to distribution.

Template examples can be found on the following three (3) pages.

To obtain “color” template copies for production visit the following link:

<http://www.virginiadot.org/business/resources/const/PublicNotificationOfParkingRestrictionsTemplates.pdf>



Door Hanger (Front)

## Asphalt

Within the next 30 days, you will see construction crews and equipment preparing to treat and improve the roads in your neighborhood. This work is **dependent on weather** and may occur later than this timeframe due to contractor schedules.

### WHAT YOU NEED TO KNOW

Crews will be paving your streets with asphalt. This application will improve the ride for motorists, and enhance the condition of your street.

### WHAT TO EXPECT

Residents will see construction workers and equipment in your neighborhood.

Stay alert for temporary lane closures.

### HOW TO PREPARE

When work begins, please avoid parking your vehicles on the street. Construction crews will place “No Parking” signs on the affected streets a minimum of 3 business days before work begins, notifying residents of the specific days parking will be prohibited. Please remove other obstructions from the road, such as basketball hoops or garbage cans.

### RESOURCES

For more information about this process, please visit [www.virginiadot.org/asphalt](http://www.virginiadot.org/asphalt).

To contact us, call VDOT’s Customer Service Center at 1-800-FOR-ROAD (800-367-7623) or email [customerservice@VDOT.Virginia.Gov](mailto:customerservice@VDOT.Virginia.Gov).

*Scan this QR code using a  
smartphone to view VDOT  
information on asphalt.*



Door Hanger (Back)

**NO** **PARKING**

**STREET PAVING**

DATES: \_\_\_\_\_ --- \_\_\_\_\_



FOR INFORMATION CALL: **1-800-FOR-ROAD**

**CARS TOWED**

**ORDER NO.: 247**  
**CONTRACT ID. NO.: CM224PMF123441B**

VIRGINIA DEPARTMENT OF TRANSPORTATION  
SPECIAL PROVISION FOR  
**SECTION 105.03—AUTHORITIES OF PROJECT  
PERSONNEL, COMMUNICATION AND DECISION MAKING  
(Asphalt Schedules Only)**

October 7, 2016

**SECTION 105.03**—Authorities of Project Personnel, Communication and Decision Making of the Specifications is amended to replace **TABLE I-2A PROCESS GUIDELINES FOR REQUESTS GENERATED BY THE CONTRACTOR** with the following:

**PROCESS GUIDELINES FOR REQUESTS GENERATED BY THE CONTRACTOR**

Process	Situation	Normal resolution process		Escalated process		Process if no resolution
		By	Within (calendar days)	By	Within	
Submittal	Contractor requests the Department's review, acceptance or approval of shop drawings, materials data, test reports, project progress schedules, or other submittals required by Specifications or other Contract Documents.	Department's Designated Project Manager	<ul style="list-style-type: none"> <li>• Acknowledge: 3 days<sup>1</sup></li> <li>• Accept or Return: 14 days</li> <li>• Final Determination/Approve: 30 days or as outlined in Contract.</li> </ul>	DA or their designee*	7 days	Submit RDA or CCR
Confirmation of Verbal Instruction (COVI)	Routine field issues, within the framework of the Contract, Contractor resolves through negotiation with the Department's field personnel.	Department's Appropriate field personnel	<ul style="list-style-type: none"> <li>• Confirmation: 1 day<sup>1</sup></li> </ul>	DA or their designee	1 day <sup>1</sup>	Submit Request for RDA
Request for Information (RFI)	Contractor needs the Department to supply information to provide better understanding of or to clarify a certain aspect of the work.	Department's Designated Project Manager	<ul style="list-style-type: none"> <li>• Action: 1 day<sup>1</sup> (or appropriate Action Plan)</li> </ul>	DA or their designee*	2 days <sup>1</sup>	Submit RDA or CCR
Request for Dept. Action (RDA)	Contractor needs the Department to take certain action Contractor feels is required for proper completion of a portion of the Work or the project.	Department's Designated Project Manager	<ul style="list-style-type: none"> <li>• Acknowledge: 1 day<sup>1</sup></li> <li>• Action: 2 days<sup>1</sup> (or appropriate Action Plan)</li> </ul>	DA or their designee*	2 days <sup>1</sup>	Submit CCR
Contract Change Request (CCR)	Contractor needs the Department to make an adjustment to the Contract because of excusable and/or compensable events, instructions that have or have not been given or other work that will require time and/or cost beyond that specified or envisioned within the original Contract.	Department's Designated Project Manager	<ul style="list-style-type: none"> <li>• Acknowledge: 3 days<sup>1</sup></li> <li>• Action: 30 days (45 days if federal oversight project)</li> </ul>	DA or their designee*	7 days	Claims process

<sup>1</sup>Process initiated on the last business day of a week shall be acknowledged before 5 pm on the next VDOT business day.

**ORDER NO.: 247**  
**CONTRACT ID. NO.: CM224PMF123441B**

VIRGINIA DEPARTMENT OF TRANSPORTATION  
SPECIAL PROVISION FOR  
**SECTION 105.06—SUBCONTRACTING**  
**(FEDERAL FUNDED PROJECTS)**

February 9, 2017

**SECTION 105.06—Subcontracting** of the Specifications is amended to include the following:

- (d) According to Commonwealth of Virginia Executive Order 20, the Contractor is encouraged to seek out and consider Small, Women-owned, and Minority-owned (SWaM) businesses certified by the Department of Small Business and Supplier Diversity (DSBSD) as potential subcontractors and vendors. Further, the Contractor shall furnish and require each subcontractor (first-tier) to furnish information relative to subcontractor and vendor involvement on the project.

For purposes of this provision, the term “vendor” is defined as any consultant, manufacturer, supplier or hauler performing work or furnishing material, supplies or services for the contract. The Contractor and, or subcontractor (first-tier) must insert this provision in each subcontract and further require its inclusion in all lower tier subcontracts (excluding purchase orders, rental agreements and other agreements for supplies or services). The applicable requirements of this provision are incorporated by reference for work done by vendors under any purchase order, rental agreement or agreement for other services for the contract. The Contractor shall be responsible for compliance by any subcontractor, lower-tier subcontractor or vendor.

The submission of a bid will be considered conclusive evidence that the Contractor agrees to assume these contractual obligations and to bind subcontractors contractually to the same at the Contractor’s expense.

When an approved Form C-31 “Subletting Request” is required according to IIM-CD-2013-06.01, the Contractor shall indicate on the Subletting Request if a subcontractor is a certified DBE or SWaM business.

The Contractor shall report all DBE, SWaM, and Non SWaM vendor payments quarterly to the District Civil Rights Office. The Contractor shall provide the information in a format consistent with Form C-63, Vendor Payment Compliance Report, subject to the approval of the Engineer.

DBE Participation and reporting shall be in accordance with the Special Provision for Section 107.15 (Use of Disadvantaged Business Enterprises).

If the Contractor fails to provide the required information, the Department may delay final payment according to Specification Section 109.10 of the Specifications.



**ORDER NO.: 247**  
**CONTRACT ID. NO.: CM224PMF123441B**

VIRGINIA DEPARTMENT OF TRANSPORTATION  
SPECIAL PROVISION FOR  
**PREVAILING WAGE RATES**

October 12, 2023

**SECTION 107 – LEGAL RESPONSIBILITIES** of the Specifications is amended as follows:

**Section 107.13 – Labor and Wages** is amended as follows:

**Section 107.13(a) Predetermined Minimum Wages** is replaced with the following:

- (a) **Prevailing Wage Rates:** The provisions of federal and state laws requiring the payment of a prevailing minimum wage rate are incorporated in and expressly made a part of this Contract. The Contractor and the Contractor's subcontractors shall promptly and fully comply with all such applicable provisions, including, but not limited to, the following.

1.0 Federal Requirements

The Contractor and subcontractors must comply with such of the regulations in 29 C.F.R. Parts 1, 3, and 5 as may be applicable to the Contract. These requirements are considered to be effective by operation of law, whether or not they are incorporated into the Contract, as set forth 29 C.F.R. § 5.5(e).

1.1 Wage Determinations

The U.S. Department of Labor (USDOL) publishes general wage determinations applicable to specified areas on the USDOL-approved website. Wage determinations contain, among other information, a list of wage and fringe benefit rates determined to be prevailing for various classifications of laborers or mechanics for specified type(s) of construction in a given area.

The applicable wage determinations are included in the Contract. These wage determinations apply for the duration of the Contract, except as specified below.

If for any reason it is determined post-award that a wage determination and/or the correct wage determination was omitted from Contract, the omitted wage determination will be incorporated into the Contract and effective by operation of law, retroactive to the award date of the Contract.

USDOL may periodically issue revisions of the wage determinations to reflect current prevailing wage rates. Revisions to wage determinations are effective with respect to the solicitation and Contract if issued at least 10 calendar days before bid opening. If issued less than 10 calendar days before bid opening, revisions are effective to the solicitation and Contract unless the Department finds that there is not a reasonable time still available before bid opening to notify bidders of the revision.

If the Contract is not awarded within 90 days after bid opening, any revised wage determination issued prior to award is effective to the Contract unless the Department obtains an extension of the original wage determination from the Administrator of the USDOL Wage and Hour Division.

1.2 Change Orders

**ORDER NO.: 247**  
**CONTRACT ID. NO.: CM224PMF123441B**

The wage determinations incorporated into the Contract at Contract execution apply for the duration of the Contract, subject to the following exceptions. When the Contract is changed to include additional, substantial construction, alteration, and/or repair work not within the scope of work of the original Contract, or to require the Contractor to perform work for an additional time period not originally obligated, including where an option to extend the term of a contract is exercised, the most recent revision of any applicable wage determination(s) published at the time the change order is issued or the option is exercised are incorporated in and applicable to the change order work. The Contractor and their subcontractors must comply with the revised wage determinations when pricing and performing the change order work.

The requirement to incorporate revised wage determinations does not apply where (i) the Contract is not changed as described in the preceding paragraph, (ii) the Contractor is simply given additional time to complete the original Contract work, or (iii) where the additional construction, alteration, and/or repair work in the change order is already within the scope of the Contract.

### 1.3 Certified Payrolls

Each Contractor or subcontractor engaged in the construction, prosecution, completion, or repair work on the Project each week must submit certified payrolls in accordance with the records and certified payrolls requirements of Form FHWA 1273, under section IV(3) - Records and certified payrolls (29 CFR 5.5), included in the Contract.

Each certified payroll required under this section must be delivered by the Contractor or subcontractor, within 7 days after the regular payment date of the payroll period in accordance with the Special Provision for Electronic Submission of Payrolls and DBE Subcontractor Payment for Federally Funded Projects (**SP107-000120-00**).

Each Contractor or subcontractor must preserve all regular payroll records for all laborers and mechanics working at the site of the work for a period of 6 years after all the work on the Contract is completed in accordance with Form FHWA 1273, section IV(3) - Records and certified payrolls (29 CFR 5.5), included in the Contract, and section 2.4, below.

### 1.4 Conformance

- A. Any class of laborers or mechanics, including helpers, which is not listed in the applicable wage determination, and which is to be employed under the Contract, must be classified in conformance with the wage determination. Conformance of an additional classification and wage rate and fringe benefits is appropriate only when the following criteria have been met:
  - (1) The work to be performed by the classification requested is not performed by a classification in the wage determination; and
  - (2) The classification is used in the area by the construction industry; and
  - (3) The proposed wage rate, including any bona fide fringe benefits, bears a reasonable relationship to the wage rates contained in the wage determination.
- B. The conformance process may not be used to split, subdivide, or otherwise avoid application of classifications listed in the wage determination.
- C. If the Contractor and the laborers and mechanics to be employed in the classification (if known), or their representatives, and the Engineer agree on the classification and wage rate (including the amount designated for fringe benefits where appropriate), a report of the action taken will be sent by the Engineer by email to

**ORDER NO.: 247**  
**CONTRACT ID. NO.: CM224PMF123441B**

*DBAconformance@dol.gov*. The Administrator of the USDOL Wage and Hour Division, or an authorized representative, will approve, modify, or disapprove every additional classification action within 30 days of receipt and so advise the Engineer or will notify the Engineer within the 30–day period that additional time is necessary.

- D. In the event the Contractor, the laborers or mechanics to be employed in the classification or their representatives, and the Engineer do not agree on the proposed classification and wage rate (including the amount designated for fringe benefits, where appropriate), the Engineer will, by email to *DBAconformance@dol.gov*, refer the questions, including the views of all interested parties and the recommendation of the contracting officer, to the Administrator of the USDOL Wage and Hour Division for determination. The Administrator, or an authorized representative, will issue a determination within 30 days of receipt and so advise the Engineer or will notify the Engineer within the 30–day period that additional time is necessary.
- E. The Engineer must promptly notify the Contractor of the action taken by the USDOL Wage and Hour Division under paragraphs (C) and (D) of this section. The Contractor must furnish a written copy of the Administrator’s determination to each affected worker, or must be post it as a part of the wage determination. The wage rate (including fringe benefits where appropriate) determined pursuant to paragraph (C) or (D) of this section must be paid to all workers performing work in the classification under this Contract from the first day on which work is performed in the classification.

2.0 Virginia Requirements

- 2.1 If the Contractor needs a job classification not listed in the wage determination to submit a bid or comply with this provision, the Contractor shall submit to the Department a completed Additional Classification and Wage Rate Request using Form C-51. If other or additional classifications are used, omission of classifications shall not be cause for additional compensation to the Contractor. The Contractor shall be responsible for determining local practices with regard to the application of the various labor classifications.
- 2.2 Upon the award of the Contract, the Contractor shall certify, under oath, to the Commissioner of the Virginia Department of Labor and Industry (VDOLI) the pay scale for each craft or trade employed on the project to be used by the Contractor and any of the Contractor's subcontractors for work to be performed under the Contract. This certification shall, for each craft or trade employed on the project, specify the total hourly amount to be paid to employees, including wages and applicable fringe benefits, provide an itemization of the amount paid in wages and each applicable benefit, and list the names and addresses of any third party fund, plan or program to which benefit payments will be made on behalf of employees. The certification form available at: [www.doli.virginia.gov/wp-content/uploads/2021/04/DOLI-Pay-Scale-Certification-for-Public-Works-Projects.pdf](http://www.doli.virginia.gov/wp-content/uploads/2021/04/DOLI-Pay-Scale-Certification-for-Public-Works-Projects.pdf). The form may be emailed to [prevailingwage@doli.virginia.gov](mailto:prevailingwage@doli.virginia.gov), faxed to 804-371-6524, or mailed to Virginia Department of Labor and Industry, 600 East Main St., Suite 207, Richmond, VA, 23219, Attn: Prevailing Wage.
- 2.3 The Contractor and the Contractor's subcontractors performing work on this Contract shall post the general prevailing wage rate for each craft and classification involved in prominent and easily accessible places accessible to all employees at the site of the work or at any such places as are used by the Contractor or subcontractors to pay workers their wages. Within 10 days of such posting, the Contractor or subcontractors shall certify to the Commissioner of VDOLI their compliance with this requirement. The certification form available at: [www.doli.virginia.gov/wp-content/uploads/2021/04/PW\\_Posting\\_Compliance\\_Form.pdf](http://www.doli.virginia.gov/wp-content/uploads/2021/04/PW_Posting_Compliance_Form.pdf). The form may be emailed

**ORDER NO.: 247**  
**CONTRACT ID. NO.: CM224PMF123441B**

to [prevailingwage@doli.virginia.gov](mailto:prevailingwage@doli.virginia.gov), faxed to 804-371-6524, or mailed to Virginia Department of Labor and Industry, 600 East Main St., Suite 207, Richmond, VA, 23219, Attn: Prevailing Wage.

- 2.4 The Contractor and the Contractor's subcontractors shall keep, maintain and preserve (i) records relating to the wages paid to and hours worked by each individual performing the work of any mechanic, laborer, or worker and (ii) a schedule of the occupation or work classification at which each individual performing the work of any mechanic, laborer, or worker on the public works project is employed during each work day and week. The employer shall preserve these records for a minimum of six years and make such records available to the Virginia Department of Labor and Industry within 10 days of a request and shall certify that records reflect the actual hours worked and the amount paid to its workers for whatever time period they request.
- 2.5 The Contractor shall insert this Special Provision into any subcontracts let to subcontractors for performance of services in connection with the Contract.

**ORDER NO.: 247**  
**CONTRACT ID. NO.: CM224PMF123441B**

SQ315-000200-24

VIRGINIA DEPARTMENT OF TRANSPORTATION  
SPECIAL PROVISION FOR  
**BALANCED MIX DESIGN (BMD) SURFACE MIXTURES DESIGNED USING PERFORMANCE  
CRITERIA**

April 24, 2023

**I. Description**

*This Specification covers the requirements and materials used to produce surface mixtures designed using performance criteria. Balanced Mix Design (BMD) surface mixtures shall be designed, produced, and placed as required by this Special Provision and Sections 211 and 315 of the Specifications.*

**II. Materials**

*All materials shall conform to Section 211.02 of the Specifications with the exception that Recycled Asphalt Shingles (RAS) will not be allowed in these mixes.*

**III. Job-Mix Formula (JMF)**

*Mix Types SM-9.5A, SM-9.5D, SM-12.5A, and SM-12.5D shall be designed to meet the Performance + Volumetric Optimized (BMD P+VO) criteria included in this section. Each mix type used shall conform to Section 211 of the Specifications. The Contractor shall submit the mix design at least two weeks before the mix is produced. Approval from the Engineer is required if the Contractor uses a binder with a PG grade not recommended by Table II-14A of Section 211 of the Specifications.*

*Type Performance + Volumetric Optimized (BMD P+VO) asphalt mixtures shall be designed to conform to Section 211.03 of the Specifications as well as Table 1 herein, except that the following table shall replace Table II-13 in Section 211.03 of the Specifications:*

<b>Asphalt Concrete Mixtures: Design Range</b>								
<b>Mix Type</b>	<b>Percentage by Weight Passing Square Mesh Sieves</b>							
	<b>¾ in</b>	<b>½ in</b>	<b>3/8 in</b>	<b>No. 4</b>	<b>No. 8</b>	<b>No. 30</b>	<b>No. 50</b>	<b>No. 200</b>
SM-9.5 A,D		100 <sup>1</sup>	90-100	90 max.	32-67			2-10
SM-12.5 A,D	100	90-100	90 max.		28-58			2-10

*The design binder content shall be selected within a range of 3.0% --4.5% air voids.*

*This mix shall conform to Table 1 at the design binder content.*

*The results of supplementary performance testing at different binder contents (informational purposes) in addition to the design binder content shall be reported as follows:*

1. *Asphalt Pavement Analyzer (APA) rut testing (VTM-142): at design binder content and at 0.5% above the design binder content*
2. *Indirect Tensile Test at High Temperature (IDT-HT) (VTM-145): at design binder content and at 0.5% above the design binder content*
3. *Cantabro testing (VTM-144): at design binder content and at 0.5% below the design binder content*
4. *Indirect Tensile Cracking Test at intermediate temperature (IDT-CT) (VTM-143): at design binder content, at 0.5% above, and at 0.5% below the design binder content*

The minimum design asphalt binder contents shall be based on the following unless otherwise approved by the Engineer:

<b>Bulk Specific Gravity of the Total Aggregate</b>	<b>Minimum Design Binder Content Mix Type (%)</b>	
	<b>SM-9.5</b>	<b>SM-12.5</b>
Less Than 2.65	5.5	5.3
2.65 - 2.74	5.4	5.2
2.74 - 2.85	5.3	5.1
Greater Than 2.85	5.2	5.0

**ORDER NO.: 247**  
**CONTRACT ID. NO.: CM224PMF123441B**

For the BMD P+VO mixtures, a set of five IDT-CT pills with the final design JMF (only at the design binder content) shall be fabricated from long-term aged loose mix and tested in accordance with ASTM D8225. Test results shall be submitted with the JMF for the mix design review. Long-term aging shall be performed by aging loose laboratory produced mix for 8 hours at 135°C, after short term oven aging is performed as required by Table 1. During long-term aging, the mix shall be uniformly placed in a pan such that the height of the loose mix shall not exceed the mixture nominal max aggregate size. Opening of the oven door shall be minimized during long-term aging. Specimens shall be heated to compaction temperature following aging and then compacted. The heating to compaction temperature shall not exceed 75 minutes.

*The JMF shall meet the nominal max aggregate size of the designated mix type. The JMF shall establish a single percentage of aggregate passing each required sieve, a single percentage of binder to be added to the mix, the SUPERPAVE volumetric properties defined by AASHTO R 35 and a temperature range at which the mixture is to be produced.*

*The Contractor shall have a Department-certified Asphalt Mix Design Technician with the BMD training certification approved by the Department for designing and adjusting mixes. The Asphalt Mix Design Technician or an Asphalt Plant Level II Technician with the BMD training certification approved by the Department shall be capable of conducting necessary performance tests. The Asphalt Mix Design Technician shall be responsible for producing a mixture that complies with the requirements of this Specification.*

Table 1  
Performance Testing Requirements for Mix Design

Performance Property	Performance Test	Test Method	Criteria
Rutting	APA Rut depth	VTM-142	≤ 8.0mm
	IDT-HT	VTM-145	Strength ≥ 100 kPa
Durability	Cantabro Mass Loss	VTM-144	Mass loss ≤ 7.5%
Cracking	IDT-CT	VTM-143	CT <sub>index</sub> ≥ 70 COV ≤ 18.3% <sup>1</sup>

1. Single operator testing tolerance: Coefficient of Variance (COV) shall be applied for the mix design IDT-CT test for all short-term aged specimens. For the long-term aged specimen test during design the COV shall be reported only for informational purposes.

*The JMF shall indicate which type of specimen preparation will be used during production for Indirect Tensile Cracking Test at intermediate temperature (IDT-CT) testing for the mix: non-reheat or reheated mixture. Throughout the production of the approved JMF, the indicated method shall be followed for every IDT-CT sample, unless otherwise approved by the Engineer.*

**IV. Production Testing**

Lot sizes defined by Sections 211 and 315 of the Specifications shall be followed for all production testing.

The Contractor shall conduct testing as required by Sections 211.05 and 211.06 of the Specifications for both A and D designated mixes. If less than 300 tons of asphalt mixture is produced under a single JMF in a day, SUPERPAVE testing will not be required on that day. That day's tonnage shall be added to subsequent production. When the accumulated tonnage exceeds 300 tons, minimum testing frequency for SUPERPAVE testing shall apply and results shall be reported.

In addition to all of the testing requirements for SUPERPAVE mixes, performance testing shall also be conducted on D designated mixes by the Contractor, in accordance with Table 2 and at the frequency

**ORDER NO.: 247**  
**CONTRACT ID. NO.: CM224PMF123441B**

shown in Table 3. The Contractor shall report BMD performance test results within 48 hrs of sampling to the Department unless otherwise approved by the appropriate District Materials Engineer  
*The approved asphalt concrete mixture shall also produce a tensile strength ratio (TSR) of not less than 0.80 in accordance with Section 211 of the Specification and as verified by the Contractor during the first lot of production.*

Table 2  
Performance Testing Requirements for Production

Performance Property	Performance Test	Test Method	Criteria
Rutting	APA Rut depth <sup>1</sup>	VTM-142	≤ 8.0mm
	IDT-HT	VTM-145	Report only COV report only
Durability	Cantabro Mass Loss	VTM-144	Mass loss ≤ 7.5%
Cracking	IDT-CT	VTM-143	CT <sub>index</sub> <sup>2</sup> ≥ 70, reheated CT <sub>index</sub> <sup>2</sup> ≥ 95, non-reheated  COV report only

1. APA Rut will be performed during production by VDOT with specimens made by the Contractor at the request of the Engineer.
2. IDT-CT specimens shall be prepared (reheat or non-reheat) in accordance with the method indicated on the JMF and VTM-143.

**Table 3**  
**Performance Testing Frequency**

Property/Test	Frequency (tons)
IDT-CT	2,000
Cantabro Mass Loss	2,000
IDT-HT <sup>1</sup>	4,000
APA Rut depth	As requested by Engineer <sup>2</sup>

1. IDT-HT shall be performed on the same sample as IDT-CT.
2. APA test will be performed by VDOT, however, specimens shall be made by the Contractor at the request of the Engineer.

**V. Acceptance**

Lot acceptance for BMD P+VO shall be as required by Section 211.08 of the Specifications.

Although acceptance will be based on Section 211, should any performance test results (based on the average of required number of specimens tested) fail to meet the criteria as specified in Table 2, the Department may require that production be stopped until corrective actions are taken by the Contractor. The Engineer will investigate and determine the acceptability of material placed and represented by failing performance test results.

**ORDER NO.: 247**  
**CONTRACT ID. NO.: CM224PMF123441B**

Field density shall be determined in accordance with Section 315 of the Specifications.

**VI. Adjustment System**

The Department will determine adjustment points in accordance with Section 211.09 of the Specifications except for the following:

- If the total adjustment is 25 points or less and the Contractor does not elect to remove and replace the material, the unit price for the material will be reduced 3% of the unit price bid for each adjustment point the material is outside of the process tolerance.
- The Engineer will reduce the unit bid price by 1.0 % for each adjustment point applied for standard deviation.
- The Engineer will increase the unit bid price by 5% if the following criteria are met: 1) the standard deviation of the binder content is within the ranges of 0.0 – 0.15; 2) there are no adjustment points assigned for any sieve sizes as noted in Table II-16; and 3) the average binder content is no less than 0.10% below and no more than 0.20% above the approved mix design binder content.

**VII. Initial Production**

Mix type BMD P+VO shall be subject to Section 211.15 of the Specifications at the Engineer's discretion.

**VIII. Measurement and Payment**

**Asphalt Concrete BMD P+VO** will be measured in tons and will be paid for at the Contract ton price. Net weight information shall be furnished with each load of material delivered in accordance with Section 211 of the Specifications. Batch weights will not be permitted as a method of measurement unless the Contractor's plant is equipped in accordance with Section 211 of the Specifications, in which case the cumulative weight of the batches will be used for payment. This price shall include all labor, equipment, and materials necessary to furnish, install, and finish the work described herein.

Payment will be made under:

<b>Pay Item</b>	<b>Pay Unit</b>
Asphalt Concrete BMD P+VO (mix type)	Ton



**ORDER NO.: 247**  
**CONTRACT ID. NO.: CM224PMF123441B**

**SQ704-000110-00**

VIRGINIA DEPARTMENT OF TRANSPORTATION  
SPECIAL PROVISION FOR  
**PAVEMENT MARKING AND MARKERS**  
(Data Logger System)

September 25, 2020

**I. DESCRIPTION**

This work shall consist of maintaining a daily log, Form [C-85](#), to record project and Contractor identification; project location; material installation time, date and location; environmental conditions; material composition; and material application rates for both temporary and permanent pavement markings and markers.

**II. PROCEDURES**

The Contractor shall maintain a daily log, Form [C-85](#), for both temporary and permanent pavement markings and markers. The C-85 form shall not be modified. All log entries shall be in electronic or legible ink format. The log shall be signed by the Contractor and delivered to the Engineer by the end of each workday. If the C-85 is in electronic format, then a printed copy, signed by the Contractor, shall be delivered to the Engineer at the end of each workday.

The Contractor shall use either of the following two methods to perform quality control (QC) testing for application thickness and glass bead rate for liquid temporary and permanent linear markings. However, the VTM 94 QC testing shall be used for all liquid linear markings that are installed by push cart.

1. **VTM 94 quality control testing:** The "Quality Control Measurements" portion of the Form C-85 shall be filled out for all markings using the VTM 94 QC testing method, and the C-85 shall be kept current throughout the day. The Contractor shall perform QC testing for application thickness and glass bead rate in accordance with VTM 94 at the beginning of each workday and every 3 hours thereafter. The Contractor shall provide the equipment needed to perform the QC testing in accordance with VTM 94. QC testing using VTM 94 shall be performed in the presence of the Inspector and shall be documented on Form C-85, immediately after testing is completed. If directed by the Engineer, the Contractor shall provide a QC test plate and the provision of the test plate shall be documented on the Form C-85. The Contractor shall also provide a printed or electronic copy of the signed Form C-85 to the District Materials Engineer for materials notebook evaluation.
2. **Data Logger System (DLS) quality control testing:** Before beginning pavement marking operations, the Contractor shall provide the DLS manufacturer's instructions for equipment calibration and operation. Each DLS shall have an annual calibration of all mechanical and electrical components and its software function and output confirmed by the DLS manufacturer or their designated representative. Evidence of the annual calibration shall be carried by a signed and dated stamp or seal affixed to the inside of the driver's door of each striper.

The Contractor shall submit electronic records from the DLS each day for all linear markings for which the Contractor is providing QC testing using this method. The record shall be produced in its final format directly from the DLS, before the records are removed from the DLS. The records shall be formatted to be read by Microsoft Excel (\*.xlsx) and shall be electronically provided to the Engineer via email or USB flash drive.

The DLS report shall include the following:

- Project number

**ORDER NO.: 247**  
**CONTRACT ID. NO.: CM224PMF123441B**

- Route number and direction
- Contractor name
- GPS coordinates for the truck's position during the application of the corresponding line, to an accuracy of within 10 feet
- Date and time for start and end of application
- Line information – color (white or yellow), pattern (skip, double, dotted, etc.), and location (i.e. left edge)
- Vehicle speed, to an accuracy of +/- 0.1 mph
- Weight or volume of binder material, with separate data entries for each 0.1 mph increment
- Weight of glass beads
- Pavement temperature (°F), surface temperature (°F), dew point (°F), air temperature (°F), and humidity (%).
- Calculate and provide average application thickness and bead application rate for each 0.1 mile increment

If the equipment critical to the DLS fails or is observed to be reporting incorrect measurements, the Contractor shall switch to using the VTM 94 QC testing method.

**III. MEASUREMENT AND PAYMENT**

**Data Logger System (DLS)** shall be included in the price bid for pavement markings and markers.

**ORDER NO.: 247**  
**CONTRACT ID. NO.: CM224PMF123441B**

SS109-002020-01

May 1, 2023

VIRGINIA DEPARTMENT OF TRANSPORTATION  
2020 ROAD AND BRIDGE SUPPLEMENTAL SPECIFICATIONS  
**SECTION 109—MEASUREMENT AND PAYMENT**

**SECTION 109—MEASUREMENT AND PAYMENT** of the Specifications is amended as follows:

**SECTION 109.08—Partial Payments** is replaced in its entirety with the following:

(a) **General**

Partial payments will be based on a monthly progress estimate consisting of approximate quantities and value of work performed as determined by the Engineer. When the method of measurement for a Contract item is in units of each or lump sum, the value of work accomplished for partial payment will be determined on a pro rata basis. Partial payments will be made once each month for the work performed in accordance with the Contract requirements. The Contractor will be given the opportunity to review the monthly progress estimate prior to each partial payment. Upon final acceptance, one last monthly estimate will be prepared and any additional payment due will be vouchered for payment.

The monthly progress estimates will be prepared in accordance with the following schedule:

1. **Contractor companies whose name begins with the letter A through F:** The monthly progress estimate will be prepared on the 4th day of each month, beginning on the first 4th day following the date of the Contract execution, and on the same day of the succeeding months as the work progresses.
2. **Contractor companies whose name begins with the letter G through P:** The monthly progress estimate will be prepared on the 11th day of each month, beginning on the first 11th day following the date of the Contract execution, and on the same day of the succeeding months as the work progresses.
3. **Contractor companies whose name begins with the letter Q through Z:** The monthly progress estimate will be prepared on the 20th day of each month, beginning on the first 20th day following the date of the Contract execution, and on the same day of the succeeding months as the work progresses.

For contracts without a payment bond, the Contractor shall submit to the Engineer a letter from each materials supplier and subcontractor involved stating that the Contractor has paid or made satisfactory arrangements for settling all bills for materials and subcontracted work that was paid on the previous month's progress estimate. The Department will use the source of supply letter and approved subletting request to verify that certifications have been received for work that was paid on the previous monthly estimate. The Contractor shall furnish these and other certificates as are required as a prerequisite to the issuance of payment for the current monthly estimate.

The Department may withhold the payment of any partial or final estimate voucher or any sum(s)

**ORDER NO.: 247**  
**CONTRACT ID. NO.: CM224PMF123441B**

thereof from such vouchers if the Contractor fails to make payment promptly to all persons supplying equipment, tools, or materials; or for any labor he uses in the prosecution of the Contract work.

Unless otherwise provided under the terms of the Contract, interest shall accrue at the rate of one percent per month.

Contractors doing business as an individual must provide their social security numbers; proprietorships, partnerships, and corporations must provide their federal employer identification numbers.

**(b) Payment to Subcontractors**

Payment to subcontractors shall be in accordance with the provisions of Code of Virginia § 2.2-4354 and § 2.2-4355 as follows.

1. Department has paid Contractor for Subcontractor's Work.

Upon the Department's payment to the Contractor for the subcontractor's portion of the work as shown on the monthly progress estimate and the receipt of payment by the Contractor for such work, the Contractor shall make compensation in full to the subcontractor. For the purposes of this Section, payment of the subcontractor's portion of the Work shall mean that payment has been issued for that portion of the Work that was identified on the monthly progress estimate for which the subcontractor has performed service.

The Contractor shall take one of the following two actions within 7 days after receipt of payment from the Department for the subcontractor's portion of the Work as shown on the monthly progress estimate:

- a. Pay the subcontractor for the proportionate share of the total payment received from the agency attributable to the Work performed by the subcontractor; or
- b. Notify the Department and subcontractor, in writing, of his intention to withhold all or a part of the subcontractor's payment along with the reason for nonpayment.

In the event payment is not made as required, the Contractor shall pay interest at the rate of one percent per month, unless otherwise provided in the Contract, to the subcontractor on all amounts that remain unpaid after 7 days, except for the amounts withheld as provided in this Section.

2. Department has not paid Contractor for Subcontractor's Work.

In the event that the Contractor has not received payment from the Department for work performed by a subcontractor under the Contract, the Contractor is liable for the entire amount owed to such subcontractor and shall pay such subcontractor within 60 days of the receipt of an invoice following satisfactory completion of the work for which the subcontractor has invoiced. The Contractor shall not be liable for amounts otherwise reducible due to the subcontractor's noncompliance with the terms of the Contract. However, in the event that the Contractor withholds all or part of the amount invoiced by the subcontractor under the terms of the Contract, the Contractor shall notify the subcontractor within 50 days of the receipt of such invoice, in writing, of his intention to withhold all or part of subcontractor's payment with the reason for nonpayment, specifically identifying the contractual noncompliance, the dollar amount being withheld, and the lower-tier subcontractor responsible for the contractual noncompliance. Payment by the party contracting with the Contractor shall not be a condition precedent to payment to any lower-tier subcontractor,

**ORDER NO.: 247**  
**CONTRACT ID. NO.: CM224PMF123441B**

regardless of the Contractor receiving payment for amounts owed to them. Any contrary provisions shall be unenforceable.

3. Nothing in this Section shall be construed to (i) apply to or prohibit the inclusion of any retainage provisions in a construction contract or (ii) apply to contracts awarded solely for professional services as that term is defined in Code of Virginia § 2.2-4301 where the Department is contracting directly with an architectural and engineering firm.
4. The Contractor shall include in each of its subcontracts provisions requiring each subcontractor to include or otherwise be subject to the same payment and interest requirements with respect to each lower tier subcontractor.
5. If the Contractor fails to make payment to the subcontractor within the time frames specified herein, the subcontractor shall notify the Engineer and the Contractor's bonding company in writing. The Contractor's bonding company shall be responsible for insuring payment in accordance with this Section and Section 107.01.

**(c) Retainage**

If the Engineer determines the Contractor's progress is unsatisfactory according to Section 108.03 or other applicable Contract documents, the Engineer will send a notice of unsatisfactory progress to the Contractor advising him of such determination. This notification will also advise the Contractor that five percent retainage of the monthly progress estimate is being withheld and will continue to be withheld for each month the Contractor's actual progress is determined to be unsatisfactory.

When the Engineer determines that the Contractor's progress is satisfactory in accordance with these requirements, the 5 percent retainage previously withheld because of unsatisfactory progress will be released in the next monthly progress estimate, and the remaining monthly progress estimates will be paid in full provided the Contractor's progress continues to be satisfactory.

**ORDER NO.: 247**  
**CONTRACT ID. NO.: CM224PMF123441B**

SS211-002020-02

May 15, 2023

VIRGINIA DEPARTMENT OF TRANSPORTATION  
 2020 ROAD AND BRIDGE SUPPLEMENTAL SPECIFICATIONS  
**SECTION 211 – ASPHALT CONCRETE**

SECTION 211 – ASPHALT CONCRETE of the Specifications is amended as follows:

Section 211.01 – Description is replaced with the following:

Asphalt concrete shall consist of a combination of mineral aggregate and asphalt material mixed mechanically in a plant specifically designed for such purpose.

An equivalent single-axle load (ESAL) will be established by the Engineer, and SUPERPAVE mix types may be specified as one of the types listed as follows:

Mix Type <sup>1</sup>	Equivalent Single-Axle Load (ESAL) Range (millions)	Minimum Asphalt Performance Grade (PG) <sup>2</sup>	Nominal Maximum Aggregate Size <sup>3</sup>
SM-4.75A	0 to 3	64S-16	No. 4
SM-4.75D	3 to 10	64H-16	No. 4
SM-4.75E	3 to 10	64E-22	No. 4
SM-9.0A	0 to 3	64S-16	3/8 in
SM-9.0D	3 to 10	64H-16	3/8 in
SM-9.0E	Above 10	64E-22	3/8 in
SM-9.5A	0 to 3	64S-16	3/8 in
SM-9.5D	3 to 10	64H-16	3/8 in
SM-9.5E	Above 10	64E-22	3/8 in
SM-12.5A	0 to 3	64S-16	1/2 in
SM-12.5D	3 to 10	64H-16	1/2 in
SM-12.5E	Above 10	64E-22	1/2 in
IM-19.0A	Less than 10	64S-16	3/4 in
IM-19.0D	10 to 20	64H-16	3/4 in
IM-19.0E	20 and above	64E-22	3/4 in
BM-25.0A	All ranges	64S-16	1 in
BM-25.0D	Above 10	64H-16	1 in

<sup>1</sup>SM = Surface Mixture; IM = Intermediate Mixture; BM = Base Mixture

<sup>2</sup>**Minimum Asphalt Performance Grade (PG)** is defined as the minimum binder performance grade for the job mix formulas as determined by AASHTO T170 or AASHTO M332.

<sup>3</sup>**Nominal Maximum Aggregate Size** is defined as one sieve size larger than the first sieve to retain more than 10 percent aggregate.

Asphalt concrete shall conform to the requirements for the mix type designated on the plans or elsewhere in the Contract for use.

At the Contractor's option, an approved Warm Mix Asphalt (WMA) additive or process may be used to produce the asphalt concrete mix type designated.

Table II-12A – Standard Deviation is renamed Aggregate Properties and is replaced with the following:

**ORDER NO.: 247**  
**CONTRACT ID. NO.: CM224PMF123441B**

TABLE II-12A  
Aggregate Properties

Mix Type	Coarse Aggregate Properties			Fine Aggregate Properties	
	CAA		ASTM D4791	SE	FAA
	1 fractured face	2 fractured faces	F & E (5:1) % by weight		
SM-4.75A				40% min	40% min
SM-4.75D				45% min	45% min
SM-4.75E				45% min	45% min
SM-9.0 A	85% min.	80% min.	10% max. <sup>1</sup>	40% min.	40% min.
SM-9.0 D	85% min.	80% min.	10% max. <sup>1</sup>	45% min.	45% min.
SM-9.0 E	95% min.	90% min.	10% max. <sup>1</sup>	45% min.	45% min.
SM-9.5 A	85% min.	80% min.	10% max. <sup>1</sup>	45% min.	45% min.
SM-9.5 D	85% min.	80% min.	10% max. <sup>1</sup>	45% min.	45% min.
SM-9.5 E	95% min.	90% min.	10% max. <sup>1</sup>	45% min.	45% min.
SM-12.5 A	85% min.	80% min.	10% max. <sup>1</sup>	45% min.	45% min.
SM-12.5 D	85% min.	80% min.	10% max. <sup>1</sup>	45% min.	45% min.
SM-12.5 E	95% min.	90% min.	10% max. <sup>1</sup>	45% min.	45% min.
IM-19.0 A	85% min.	80% min.	10% max. <sup>1</sup>	45% min.	45% min.
IM-19.0 D	95% min.	90% min.	10% max. <sup>1</sup>	45% min.	45% min.
IM-19.0 E	95% min.	90% min.	10% max. <sup>1</sup>	45% min.	45% min.
BM-25.0 A	80% min.	75% min.	10% max. <sup>1</sup>	45% min.	45% min.
BM-25.0 D	80% min.	75% min.	10% max. <sup>1</sup>	45% min.	45% min.

<sup>1</sup>10 percent measured at 5:1 on maximum to minimum dimensions

Table II-13 – Asphalt Concrete Mixtures: Design Range is replaced with the following:

**TABLE II-13**  
**Asphalt Concrete Mixtures: Design Range**

Mix Type	Percentage by Weight Passing Square Mesh Sieves										
	1 1/2 in	1 in	3/4 in	1/2 in	3/8 in	No. 4	No. 8	No. 16	No. 30	No. 50	No. 200
SM-4.75 A,D,E				100 <sup>1</sup>	95-100	90-100		30-55			6-13
SM-9.0 A,D,E				100 <sup>1</sup>	90-100	90 max.	47-67				2-10
SM-9.5 A,D,E				100 <sup>1</sup>	90-100	58-80	38-67		23 max		2-10
SM-12.5 A,D,E			100	95-100	90 max.	58-80	34-50		23 max		2-10
IM-19.0 A,D,E		100	90-100	90 max.	--	--	28-49				2-8
BM-25.0 A,D	100	90-100	90 max.	--	--	--	19-38				1-7
C (Curb Mix)				100	92-100	70-75	50-60		28-36	15-20	7-9

<sup>1</sup>A production tolerance of 1% will be applied to this sieve regardless of the number of tests in the lot.

Table II-14 – Mix Design Criteria is replaced with the following:

**ORDER NO.: 247**  
**CONTRACT ID. NO.: CM224PMF123441B**

**TABLE II-14**  
**Mix Design Criteria**

<b>Mix Type</b>	<b>VTM (%) Production</b>	<b>VFA (%) Design</b>	<b>VFA (%) Production</b>	<b>Min. VMA (%)</b>	<b>Fines/Asphalt Ratio</b>	<b>No. of Gyrations N Design</b>
SM4.75A <sup>2,4</sup>	3.0-6.0	70-75	70-80	16.5	1.0-2.0	50
SM4.75D <sup>2,4</sup>	3.0-6.0	70-75	70-80	16.5	1.0-2.0	50
SM4.75E <sup>2,4</sup>	3.0-6.0	70-75	70-80	16.5	1.0-2.0	50
SM-9.0A <sup>1,2</sup>	2.0-5.0	75-80	70-85	17.0	0.6-1.3	50
SM-9.0D <sup>1,2</sup>	2.0-5.0	75-80	70-85	17.0	0.6-1.3	50
SM-9.0E <sup>1,2</sup>	2.0-5.0	75-80	70-85	17.0	0.6-1.3	50
SM-9.5A <sup>1,2</sup>	2.0-5.0	75-80	70-85	16.0	0.7-1.3	50
SM-9.5D <sup>1,2</sup>	2.0-5.0	75-80	70-85	16.0	0.7-1.3	50
SM-9.5E <sup>1,2</sup>	2.0-5.0	75-80	70-85	16.0	0.7-1.3	50
SM-12.5A <sup>1,2</sup>	2.0-5.0	73-79	68-84	15.0	0.7-1.3	50
SM-12.5D <sup>1,2</sup>	2.0-5.0	73-79	68-84	15.0	0.7-1.3	50
SM-12.5E <sup>1,2</sup>	2.0-5.0	73-79	68-84	15.0	0.7-1.3	50
IM-19.0A <sup>1,2</sup>	2.0-5.0	69-76	64-83	14.0	0.6-1.3	50
IM-19.0D <sup>1,2</sup>	2.0-5.0	69-76	64-83	14.0	0.6-1.3	50
IM-19.0E <sup>1,2</sup>	2.0-5.0	69-76	64-83	14.0	0.6-1.3	50
BM-25.0A <sup>2,3</sup>	1.0-4.0	67-87	67-92	13.0	0.6-1.3	50
BM-25.0D <sup>2,3</sup>	1.0-4.0	67-87	67-92	13.0	0.6-1.3	50

<sup>1</sup>Binder content should be selected at 4.0% air voids for A & D mixes, 3.5% air voids for E mix.

<sup>2</sup>Fines-asphalt ratio is based on effective binder content.

<sup>3</sup>Base mix shall be designed at 2.5% air voids. BM-25A shall have a minimum binder content of 4.4% unless otherwise approved by the Engineer. BM-25D shall have a minimum binder content of 4.6% unless otherwise approved by the Engineer.

<sup>4</sup> Binder content shall be selected at 5.0 percent air voids.

**211.02—Materials (h)- is replaced with the following**

**(h)** An antistripping additive shall be used in all asphalt mixes. It may be hydrated lime or a chemical additive from the Materials Division Approved List No. 7 or a combination of both. When using an approved chemical additive, it shall be added at a rate of not less than 0.30 percent by weight of the total asphalt content of the mixture unless otherwise indicated on the Department's Approved List No. 7.

**211.02—Materials (m)- is replaced with the following**

**(m)** Warm Mix Asphalt (WMA) additives or processes shall be approved by the Department prior to use and shall be obtained from the Department's Approved List No. 66. When using an approved chemical additive, it shall be added at a rate of not less than 0.50 percent by weight of the total asphalt content of the mixture unless otherwise indicated on the Department's Approved List No. 66.

Section 211.03(d)8 – For surface mixes is replaced with the following:

For surface mixes, permeability test data shall be submitted in accordance with VTM-120 using either single point verification or the regression method for each surface mix having a different gradation. The specimen height shall be one inch for SM-4.75 mix types. If the average of the



**ORDER NO.: 247**  
**CONTRACT ID. NO.: CM224PMF123441B**

permeability results from the single point verification method exceeds  $150 \times 10^{-5}$  cm/sec, or if the regression method predicts a permeability exceeding  $150 \times 10^{-5}$  cm/sec at 7.5% voids, the Contractor shall redesign the mixture to produce a permeability number less than  $150 \times 10^{-5}$  cm/sec.

Section 211.04(a) – Types SM-9.0A, SM-9.0D, SM-9.0E, SM-9.5A, SM-9.5D, SM-9.5E, SM-12.5A, SM-12.5D, and SM-12.5E asphalt concrete is renamed Types SM-4.75A, SM-4.75D, SM-4.75E, SM-9.0A, SM-9.0D, SM-9.0E, SM-9.5A, SM-9.5D, SM-9.5E, SM-12.5A, SM-12.5D, and SM-12.5E asphalt concrete and replaced with the following:

Types SM-4.75A, SM-4.75D, SM-4.75E, SM-9.0A, SM-9.0D, SM-9.0E, SM-9.5A, SM-9.5D, SM-9.5E, SM-12.5A, SM-12.5D, and SM-12.5E asphalt concrete shall consist of crushed stone, crushed slag, or crushed gravel and fine aggregate; slag or stone screenings; or a combination thereof combined with asphalt binder.

For all surface mixes, except where otherwise noted, no more than 5% of the aggregate retained on the No. 4 sieve and no more than 20% of the total aggregate may be polish-susceptible. At the discretion of the Engineer, SM-9.5AL or SM-12.5AL may be specified and polish susceptible aggregates may be used (without percentage limits).

Unless Type C (curb mix) is specified by the Engineer in the Contract, SM-9.0, SM-9.5, and SM-12.5 mix types are acceptable for use in the construction of asphalt curbing.

Section 211.04(e) – Type SM-9.5, SM-12.5, IM-19.0 and BM-25.0 asphalt concrete is renamed Type SM-4.75, SM-9.5, SM-12.5, IM-19.0 and BM-25.0 asphalt concrete and amended to replace the first paragraph with the following:

Type SM-4.75, SM-9.5, SM-12.5, IM-19.0 and BM-25.0 asphalt concrete may be designated E (polymer modified), or stabilized (S). Asphalt concrete mixtures with the E designation may not be stabilized.

Table II-15 – Process Tolerance is replaced with the following:

**TABLE II-15**  
**Process Tolerance**

Tolerance on Each Laboratory Sieve and Binder Content: Percent Plus and Minus													
No. Tests	Top Size <sup>1</sup>	1 ½"	1"	¾"	½"	3/8"	No. 4	No. 8	No. 16	No. 30	No. 50	No. 200	A.C.
1	0.0	8.0	8.0	8.0	8.0	8.0	8.0	8.0	8.0	6.0	5.0	2.0	.60
2	0.0	5.7	5.7	5.7	5.7	5.7	5.7	5.7	5.7	4.3	3.6	1.4	0.43
3	0.0	4.4	4.4	4.4	4.4	4.4	4.4	4.4	4.4	3.3	2.8	1.1	0.33
4	0.0	4.0	4.0	4.0	4.0	4.0	4.0	4.0	4.0	3.0	2.5	1.0	0.30
5	0.0	3.6	3.6	3.6	3.6	3.6	3.6	3.6	3.6	2.7	2.2	0.9	0.27
6	0.0	3.3	3.3	3.3	3.3	3.3	3.3	3.3	3.3	2.4	2.0	0.8	0.24
7	0.0	3.0	3.0	3.0	3.0	3.0	3.0	3.0	3.0	2.3	1.9	0.8	0.23
8	0.0	2.8	2.8	2.8	2.8	2.8	2.8	2.8	2.8	2.1	1.8	0.7	0.21
12	0.0	2.3	2.3	2.3	2.3	2.3	2.3	2.3	2.3	1.7	1.4	0.6	0.17

<sup>1</sup>Defined as the sieve that has 100% passing as defined in Table II-13.

Section 211.08 – Acceptance is amended by replacing the sixth paragraph with the following:

Binder content will be measured as extractable binder or weight after ignition. The Contractor shall submit a copy of burn tickets from an ignition oven to the Engineer and all the original tickets shall be available upon Engineer's request. The Engineer shall be notified within 24 hours from testing of a report edit if the

**ORDER NO.: 247**  
**CONTRACT ID. NO.: CM224PMF123441B**

date and time on a ticket do not match information submitted in PLAID. Original tickets shall be maintained on file by the Contractor for a period of 5 years or until final acceptance of the applicable contract, whichever is greater.

Section 211.09 – Adjustment System is amended by replacing the first paragraph and following table with the following:

If a lot of material does not conform to the acceptance requirements of Section 211.08, the Department will determine adjustment points as follows:

**Adjustment Points for Each 1% the Gradation Is Outside the  
Process Tolerance Permitted In Table II-15**

<b>Sieve Size</b>	<b>(Applied in 0.1% increments)</b>
1 1/2 in	1
1 in	1
3/4 in	1
1/2 in	1
3/8 in	1
No. 4	1
No. 8	1
No. 16	1
No. 30	2
No. 50	2
No. 200	3

**ORDER NO.: 247**  
**CONTRACT ID. NO.: CM224PMF123441B**

SS220-002020-01

August 28, 2020

VIRGINIA DEPARTMENT OF TRANSPORTATION  
2020 ROAD AND BRIDGE SUPPLEMENTAL SPECIFICATIONS  
**SECTION 220 – CONCRETE CURING MATERIALS**

SECTION 220 – CONCRETE CURING MATERIALS of the Specifications is amended as follows:

**Section 220.02(a) – Waterproof paper** is replaced with the following:

**Waterproof paper** shall conform to ASTM C171. One side shall be composed of white, light-reflecting paper.

**Section 220.02(b) – PE film** is replaced with the following:

**PE film** shall conform to ASTM C171 except that its nominal thickness shall be 3.0 mils. The thickness at any point shall be at least 2.5 mils.

**Section 220.02(c) – Burlap and PE film** is replaced with the following:

**Burlap and PE film** may be used in combination. They shall be bonded securely so that they cannot be easily separated in a dry or saturated condition. White PE film shall conform to the reflectance requirements of ASTM C171. Burlap shall conform to Section 220.02(f). The combination product shall have a total weight of 11 ounces per square yard with 11 threads of burlap per inch.

**Section 220.02(f) – Burlap** is inserted as follows:

**Burlap** used by itself shall conform to AASHTO M 182, Class 3, except the weight of each sample may vary by 10%. Acceptance shall be based on the average weight of all samples submitted according to AASHTO M 182, Table 3. If any individual sample is outside the 10% tolerance, the lot will be rejected.

**ORDER NO.: 247**  
**CONTRACT ID. NO.: CM224PMF123441B**

SS223-002020-02

April 4, 2023

VIRGINIA DEPARTMENT OF TRANSPORTATION  
2020 ROAD AND BRIDGE SUPPLEMENTAL SPECIFICATIONS

**SECTION 223 – STEEL REINFORCEMENT**

SECTION 223 – STEEL REINFORCEMENT of the Specifications is amended as follows:

**SECTION 223.02(a) – Reinforcement** is replaced as follows:

1. **Deformed bars** shall conform to ASTM A615, Grade 40 or 60; or ASTM A706, Grade 60. Longitudinal bars for continuous reinforced hydraulic cement concrete pavement shall be Grade 60.
2. **Plain bars** shall conform to ASTM A615, Grade 40 or 60; or ASTM A706, Grade 60, deformation waived. When used as a dowel, material may be a plain bar conforming to the requirements of ASTM A615, Grade 40 or 60, or a plain dowel conforming to the requirements of ASTM A709, Grade 36; or ASTM A706, Grade 60.
3. **Welded wire fabric** shall conform to ASTM A1064. When used in continuously reinforced hydraulic cement concrete pavement wire fabric shall be deformed, furnished in flat sheets, and shall conform to ASTM A1064, Grade 70.
4. **Structural steel** shall conform to Section 226.
5. **Bar mats** shall conform to ASTM A184.
6. **Spiral wire** shall conform to AASHTO M32 or ASTM A1064.
7. Wire mesh for use in gabions shall be made of galvanized steel wire at least 0.105 inch, 12 gage, in diameter. The tensile strength of the wire shall be at least 60,000 pounds per square inch. Wire mesh shall be galvanized in accordance with ASTM A641, Class 3. When PVC coating is specified, it shall be at least 0.015 inch in thickness and shall be black.

Wire shall be welded to form rectangular openings or twisted to form hexagonal openings of uniform size. The linear dimension of the openings shall be not more than 4 1/2 inches. The area of the opening shall be not more than 9 square inches. The unit shall be nonraveling. Nonraveling is defined as the ability to resist pulling apart at any of the twists or connections forming the mesh when a single wire strand in a section is cut.

**ORDER NO.: 247**  
**CONTRACT ID. NO.: CM224PMF123441B**

SS234-002020-01

May 6, 2022

VIRGINIA DEPARTMENT OF TRANSPORTATION  
2020 ROAD AND BRIDGE SUPPLEMENTAL SPECIFICATIONS  
**SECTION 234 – GLASS BEADS AND RETROREFLECTIVE OPTICS**

**SECTION 234 – GLASS BEADS FOR REFLECTORIZING TRAFFIC MARKINGS** of the Specifications is replaced as follows:

**SECTION 234 – GLASS BEADS AND RETROREFLECTIVE OPTICS**

**234.01 – Description**

This specification covers glass beads and retroreflective optics applied on the surface or incorporated into traffic-marking materials so as to produce a retroreflective surface.

**234.02 – Detail Requirements**

Glass beads and retroreflective optics shall be supplied from a supplier listed on Materials Approval List No. 76.

The Contractor shall provide a written certification that each batch of glass beads or retroreflective optics used in or on VDOT pavement markings meets VDOT specifications and does not exceed the AASHTO M 247 maximum concentration limits for Lead and Arsenic.

- (a) **Glass beads** shall have a composition designed to be highly resistant to traffic wear and weather. Materials other than glass will be allowed if the pavement marking product was tested on the NTPEP test deck with the alternative bead material.

Glass beads shall have a Refractive Index of 1.50-1.79 when tested as per AASHTO T 346.

Glass beads shall conform to AASHTO M 247, except that at least 80 percent of the beads shall be round when tested in accordance with ASTM D 1155, Procedure B.

- (b) **Retroreflective Optics** shall have a concentration designed to be highly resistant to traffic wear and weather. Retroreflective Optics shall be composed of glass beads, ceramic materials, or a combination of glass beads or ceramic materials affixed to a glass bead core.

Retroreflective Optics shall have a Refractive Index of 1.8 or higher when tested as per AASHTO T 346.

**ORDER NO.: 247**  
**CONTRACT ID. NO.: CM224PMF123441B**

SS235-002020-01

May 6, 2022

VIRGINIA DEPARTMENT OF TRANSPORTATION  
2020 ROAD AND BRIDGE SUPPLEMENTAL SPECIFICATIONS  
**SECTION 235 – RETROREFLECTORS**

**SECTION 235 – RETROREFLECTORS** of the Specifications is deleted and replaced as follows:

**235.01 – Description**

Retroreflectors are retroreflective surfaces that redirect the vehicle headlights back to the driver to delineate the road. The retroreflective surface may consist of a plastic prismatic reflector or retroreflective sheeting. Retroreflectors are used with:

- Pavement Markers (Permanent and Temporary)
- Delineators (Guardrail, Barrier, Flexible Post, Road Edge)

Pavement markers and Delineators shall be approved by reviewing performance data from one or both of the following test programs:

- (a) AASHTO's National Transportation Product Evaluation Program (AASHTO/NTPEP). Test data values used for approval may be based upon the data generated per the applicable NTPEP Work Plan.
- (b) VDOT Test Facility – VDOT may elect to evaluate performance from their own test facility.

**235.02 – Detail Requirements**

- (a) **Inlaid Pavement Markers** – Holders for inlaid pavement markers shall be made of polycarbonate plastic nominally 4.75 inches wide excluding breakaway tabs, and shall be able to hold retroreflectors from the Department's Approved List 22 under Inlaid Pavement Markers. The top of the the retroreflector shall be 1/8 inch below the pavement surface when installed with the breakaway positioning tabs resting on the pavement surface.

Retroreflectors for inlaid pavement markers shall have a nominal width of 4 inches excluding the holders.

- (b) **Pavement Markers (Temporary)** – Refer to VTM-70 for testing and approval
- (c) **Pavement Markers (Permanent)** – Refer to VTM-70 for testing and approval
- (d) **Delineators** – Refer to VTM-70 for testing and approval
- (e) **Aluminum panels for delineators** shall be at least 0.064 inch thick conforming to ASTM B-209, alloy 5052.

**ORDER NO.: 247**  
**CONTRACT ID. NO.: CM224PMF123441B**

SS236-002020-01

May 14, 2021

VIRGINIA DEPARTMENT OF TRANSPORTATION  
2020 ROAD AND BRIDGE SUPPLEMENTAL SPECIFICATIONS  
**SECTION 236 – WOOD PRODUCTS**

**SECTION 236 WOOD PRODUCTS** of the Specifications is amended as follows:

**236.02 – Detail Requirements** is replaced with the following:

- (a) **Structural timber and lumber** shall conform to AASHTO M168. The species and grade of structural lumber shall be as shown on the plans. .

Except as otherwise specified, the species and grade of structural lumber, timber, and posts for the following applications shall be as follows:

1. **Bridges** shall be at least 1,550(psi) Fb (Fiber Bending) and:
    - 5 inch by 5 inch and larger: Southern Pine, No. 1 Dense.
    - 2 inch through 4 inch by 2 inch through 4 inch: Southern Pine, No. 1 Dense.
    - 2 inch through 4 inch by 5 inch and through 6 inch: Southern Pine, Non-Dense Select Structural
    - 2 inch through 4 inch by 8 inch only: Southern Pine, Non-Dense Select Structural.
    - 2 inch through 4 inch by 10 inch only: Southern Pine, Select Structural.
    - 2 inch through 4 inch by 12 inch only: Southern Pine, Select Structural.
  2. **Signs** shall be at least 1,100 (psi) Fb with material being dressed on all sides and:
    - 4 inches and less in the least dimension: Southern Pine, No. 2.
    - Over 4 inches in the least dimension: Southern Pine, No. 1.
  3. **Guardrail** shall be at least 1550 (psi) Fb Southern Pine, No. 1 Dense.
  4. **Fence** shall be Southern Pine, No. 2, for line, corner, and brace units.
  5. **Signalization and electrical service** shall conform to ANSI Class 05.1. Sawn material, both rough and dressed, shall be certified by the mill as to grade and shall be grade marked in accordance with the grading rules and basic provisions of the American Lumber Standards (PS-20-70) by a lumber grading or inspection bureau or agency approved by the Department. The grade mark shall be applied after dressing if the sawn material is dressed.
- (b) **Timber piles** shall conform to ASTM D25. Piles shall be clean peeled and have a butt circumference of at least 31 inches. The Engineer will accept piles for fender systems or other nonload bearing uses under the following criteria provided the piles can be properly driven: A straight line from the center of the butt to the center of the tip may lie partly outside the body of the pile, but the distance between the line and pile shall be not more than 1/2 percent of the length of the pile or 3 inches, whichever is smaller.

**ORDER NO.: 247**  
**CONTRACT ID. NO.: CM224PMF123441B**

Points for timber piles shall be steel or cast iron and of a shape that will allow a secure connection to the pile and withstand driving.

Timber piles shall be branded prior to shipment with the supplier brand, year of treatment, species of timber and preservative treatment, retentions, class, and length. Brand symbols shall conform to AWWA M6.

- (c) **Wood Preservatives** - Wood preservatives shall conform to the requirements of the American Wood Protection Association (AWPA) U1 Standards. The AWWA designates the different wood exposure conditions in the following "Use Category System":

UC4A: Above ground, ground contact, fresh water contact or other conditions favorable to wood deterioration. (For Example: sign posts, fence posts and gates).

UC4B: Ground contact in severe environments, critically important components and salt water splash zones (For Example: bridge timbers, bridge decking, guardrail posts and offset blocks).

UC4C: Ground contact in very severe environments, or climates with an extremely high potential for deterioration of critical structural components.  
(For Example: foundation pilings).

UC5B: Wood exposed to salt and brackish water (For Example: piles, bracing and bulk-heads).

**Wood preservatives for Highway Construction and Hand-Contact Surfaces, listed in Tables 1 and 2 below** shall be used according to their suitability for the wood exposure condition and shall not be used interchangeably.

1. Wood used for **Highway Construction** (including but not limited to - bicycle trails, pedestrian overlooks, maintenance applications for posts (sign, fence, guardrail), bridge decking, gates, stair treads, and offset blocks, piles, timbers, and composites) shall be treated with the following preservative per **Table 1** below:

Chromated Copper Arsenate (CCA)

Creosote

Pentachlorophenol (PCP)

Dichloro Octyl Isothiazolin (DCOI)



**ORDER NO.: 247**  
**CONTRACT ID. NO.: CM224PMF123441B**

**Table 1 – Southern Yellow Pine Treatments & Retentions for Highway Construction per AWWA**

Commodity Specifications		Use Category	Preservative Retentions			
			Waterborne (pcf)	Oil borne (pcf)		
Desig	Wood Usage		CCA	Creosote	PCP	DCOI
A	<b>Sawn Products:</b> Boards, lumber and timber	UC4A	0.40	10.0	0.50	0.15
	Lumber and Timber products for bridge structures, bridge decking, gates, and stair treads	UC4C	0.60	12.0 *	0.50	0.2
B	<b>Posts:</b> Round, 1/2 and 1/4 round, building, fence and sign posts, poles < 16 feet in length.	UC4A	0.40	N/A	N/A	0.13
	Guardrail Posts and offset blocks	UC4B	0.50	N/A	N/A	0.17
E	<b>Round Timber Pilings:</b> Pilings and foundations for land and fresh water use	UC4C	0.80	12.0	0.60	0.2
F	<b>Wood Composites:</b> Plywood	UC4A	0.40	10.0	0.50	0.2
	**Glue laminated members (glue then treat)	UC4A	N/A	10.0	0.60	0.2
	**Glue laminated members (treat then glue)	UC4A	0.40	10.0	0.60	0.2
	Laminated veneer lumber	UC4A	N/A	10.0	N/A	N/A
G	<b>Marine Applications</b> (in or above salt water, brackish water, or tidal water) Plywood & Solid Sawn	UC5B	2.5	25.0	N/A	N/A
	Piles (outer zone/inner zone)	UC5B	2.5/1.5	20.0	N/A	N/A
	Sawn - Dual treatment: CCA with CR	UC5B	1.5	20.0	N/A	N/A
	Piles - Dual treatment: CCA with CR	UC5B	1.0	20.0	N/A	N/A

**\*Creosote (CR) preservative is not allowed for bridge decks.**

**\*\*For Glue laminated members Contractor must certify glue is compatible with treatment**

- Wood used for **Hand-Contact Surfaces** (including but not limited to handrails, playground equipment, and picnic tables shall be treated with the following non-arsenical, water-borne preservatives per **Table 2** below:

Alkaline Copper Quat (ACQ)  
Copper Azole (CA)  
Micronized Copper Azole (MCA)

**ORDER NO.: 247**  
**CONTRACT ID. NO.: CM224PMF123441B**

Table 2 – Southern Yellow Pine Treatments & Retentions for Hand-Contact Surfaces per AWP					
Commodity Specifications		Use Category	Preservative Retentions		
Designation	Wood Usage		Waterborne (pcf)		
			ACQ- A,B,C,D **	CA-B CA-C **	MCA, MCA- C **
A	<b>Sawn Products:</b> Boards, lumber and timber for picnic tables, handrails, playground equipment	UC4B	0.60	0.31	0.31
F	<b>Wood Composites:</b> Plywood for picnic tables, handrails, playground equipment	UC4B	0.60	0.31	0.31

**\*\* Note – ACQ, CA, MCA - Many wood treatments can be highly corrosive to metal under some conditions.** Fasteners or connectors that will be in contact with wood using ACQ, CA, MCA wood preservative treatments shall be either 304 or 316 stainless steel or hot-dipped galvanized steel that conforms to ASTM A153 or ASTM A653, Class G185. The Engineer will not permit the use of mechanically galvanized steel hardware or fasteners with ACQ, CA, MCA treated wood. Wood treated with ACQ, CA, MCA shall be separated from steel or aluminum beams or posts using a non-metallic, rubber flashing.

Treatment shall conform to these additional requirements:

1. Waterborne preservatives shall be used for timber where a clean surface is desirable. The moisture content of wood material shall be not more than 19 percent at the time of treatment.
2. Oilborne preservatives (Pentachlorophenol, Creosote, Copper Naphthenate) may be used for timber that is not to be painted. Timbers treated with Pentachlorophenol, Creosote, or Copper Naphthenate shall be free of excess preservative on the wood surface. VDOT allows oilborne preservatives for special projects.
3. Field Cuts to Treated Wood - All cuts, pile cutoffs, bolt holes, field cuts and damage which penetrates the treated zone shall be protected in accordance with AWP Standard M4. In cases in which the originally used preservative is not available for field use, copper naphthenate with minimum 2% copper metal shall be used. In all cases 3 heavy brushed applications of any preservative shall be used, with adequate penetration time between applications.
4. For any product not listed, refer to the latest AWP, U1 Standard.
5. Treated timber shall be supplied only from facilities on Approved List # 45.

**ORDER NO.: 247**  
**CONTRACT ID. NO.: CM224PMF123441B**

SS246-002020-02

May 6, 2022

VIRGINIA DEPARTMENT OF TRANSPORTATION  
2020 ROAD AND BRIDGE SUPPLEMENTAL SPECIFICATIONS  
**SECTION 246 – PAVEMENT MARKING**

**SECTION 246 – PAVEMENT MARKING** of the Specifications is amended as follows:

**Section 246.02 – Detail Requirements** is amended to replace the fifth through seventh paragraphs with the following:

Pavement marking materials shall produce a retroreflective line, message, legend or symbol of specified thickness, width or design in accordance with the MUTCD and Contract requirements.

Pavement marking material shall have the pigment, glass beads, retroreflective optics, and filler well dispersed in the resin, and shall be free from skins, dirt, and foreign objects.

Glass beads and retroreflective optics shall conform to Section 234.

**Section 246.02(a) – Approval of Pavement Markings** is amended to replace the second paragraph of the second bullet with the following:

When pavement markings are installed on the NTPEP test deck or the VDOT facility, the material's thickness, beads/retroreflective optics, and formulation shall be documented to ensure the equivalent thickness, beads/retroreflective optics and formulation are installed on VDOT roadways following approval.

**Section 246.02(b) – Certifications** is replaced with the following:

The pavement marking material manufacturer shall certify each batch or lot of material supplied and installed is the same product (thickness, retroreflective optics package and formulation) that was tested and approved on the AASHTO/NTPEP or VDOT test facility in accordance with the Materials Division, Manual of Instructions for Certification I and II Materials. The certification shall include the NTPEP test number from the Materials Division's Approved Products List. The Contractor shall retain the manufacturer's certifications.

**Section 246.02(c) – Warranty Requirements** is amended to replace the first paragraph with the following:

Pavement marking products shall carry the warranties as supplied by the manufacturer of the individual marking types (classes) for the specific timeframes per type and class and the material requirements for retroreflectivity, durability, color, luminance (Y%), and adhesion as referenced herein. Warranties shall be those commercially supplied or those unique to the Commonwealth in the case of certain products, such as Type B, Class VI preformed pavement marking tape as detailed herein. Manufacturers' warranties shall be obtained by the Contractor and assigned to the Department in writing prior to final acceptance. Warranty periods shall begin on the date of receipt at the project as verified by delivery tickets signed by the Engineer.

**Section 246.03(a) – Paint Pavement Marking Materials (Type A)** is renamed **Section 246.03(a) – Conventional or Cold Weather Paint Marking Materials (Type A, Class I)** and amended to replace the first paragraph with the following:

Type A, Class I paint material shall be a fast-drying, waterborne, nonleaded, acrylic or modified acrylic resin paint suitable for use on both asphalt and hydraulic cement concrete pavement surfaces and shall be selected from the Materials Division's Approved Products List No. 20. Type A, Class I material shall be designed to be applied at approximately 15 mils wet film thickness in conjunction with AASHTO M 247 Type I beads as per Section 234 of the Specifications.

**ORDER NO.: 247**  
**CONTRACT ID. NO.: CM224PMF123441B**

Type A, Class I cold weather paint shall be capable of being both applied and remaining fully adhered to the surface at temperatures below 40 °F.

**Section 246.03(a)1e – IR Scan from NTPEP** is replaced with the following:

e. **IR Scan from NTPEP.**

**Section 246.03(b) – High Build Paint Marking Materials (Type A, Class II)** is added as follows:

Type A, Class II Paint material shall be a fast-drying, waterborne, nonleaded, acrylic or modified acrylic resin paint suitable for use on both asphalt and hydraulic cement concrete pavement surfaces and shall be selected from the Materials Division’s Approved Products List No. 20. Type A, Class II material shall be designed to be applied at approximately 27 mils wet film thickness.

1. **Initial Approval** - Maintained retroreflectivity, color (including luminance), and durability shall conform to the following requirements after the material has been installed on the test deck for 1 year:

a. **Maintained Retroreflectivity:** The photometric quantity to be measured is the coefficient of retroreflected luminance ( $R_L$ ) in accordance with ASTM E1710 for 30-meter geometry.  $R_L$  shall be expressed in millicandelas per square foot per foot-candle when measured in the skipline or centerline areas:

<b>Coefficient of Retroreflected Luminance (<math>R_L</math>) (mcd/ft<sup>2</sup>/fc) Paint</b>		
<b>Color</b>	<b>Initial</b>	<b>1 Year In-Service</b>
White	300	125
Yellow	225	100

I.

b. **Day and Nighttime Color and Luminance (Y%):** Measured according to ASTM D6628.

c. **Durability:** Paint shall have a durability rating of at least 8 when determined in the wheel path area when tested in accordance with the NTPEP Work Plan.

d. **Skid Resistance:** The initial skid resistance shall be at least 45 BPN when tested according to ASTM E303, if available.

e. **IR Scan from NTPEP.**

2. **Batch Testing**

II. Paint batch testing shall be performed by the Department on samples obtained from the point of manufacture or from the field in accordance with the Materials Division’s Manual of Instructions. The test results shall be compared against NTPEP lab test results and the Specifications. Testing shall be performed to determine the following physical requirements and properties:

a. **Solids, (% weight)** according to ASTM D2369: Acceptable range from NTPEP results (+/- 2%).

b. **Pigment (% weight)** according to ASTM D3723: Acceptable range from NTPEP results (+/- 2%).

c. **Density (wt/gal.)** according to ASTM D1475: Acceptable range from NTPEP results (+/-0.3 lbs/gal).

d. **Viscosity (KU)** according to ASTM D562: Acceptable range from NTPEP results (+/-5KU).

**ORDER NO.: 247**  
**CONTRACT ID. NO.: CM224PMF123441B**

- e. **Contrast Ratio** according to ASTM D2805 (2°,D 65): Paint shall show a dry hiding quality that will give a contrast ratio of at least 0.96 at (15 mil) wet film thickness.
- f. **Day Color, Luminance (Y%) - (without Drop-on Beads):**
- III. Color testing results shall conform to the chromaticity coordinate limits that follow. Color determination for paint materials will be made without drop-on beads at least 24 hours after application in accordance with ASTM D6628.

<b>Day Color, Chromaticity Coordinates (Without Drop-on Beads), High Build Paint</b>									
	<b>x</b>	<b>y</b>	<b>x</b>	<b>y</b>	<b>x</b>	<b>y</b>	<b>x</b>	<b>y</b>	<b>Y%</b>
White	0.355	0.355	0.305	0.305	0.285	0.325	0.335	0.375	80.0 Min
Yellow	0.493	0.473	0.518	0.464	0.486	0.428	0.469	0.452	50.0-60.0

- g. **Settling properties:** Settling shall be no less than a rating of 8 when tested in accordance with the NTPEP Work Plan.
- h. **Freeze-thaw and heat stability:** Paint shall show no coagulation or change in viscosity greater than +/- 5 KU when tested in accordance with the NTPEP Work Plan.
- i. **Water resistance:** Paint shall show no blistering, peeling, wrinkling, softening, or loss of adhesion when tested in accordance with the NTPEP Work Plan.
- j. **VOC:** The VOC content shall be no greater than 150 grams/liter when tested in accordance with EPA Method 24.
- k. **Flash point:** Paint shall have a flash point of at least 201 degrees F when tested in accordance with ASTM D93, Pensky-Martens Closed Cup.
- l. **Infrared (IR) Scan:** Shall match IR scan from NTPEP.

**Section 246.03(b) – Thermoplastic Marking Materials (Type B, Class I)** is renumbered as 246.03(c) and replaced as follows:

Thermoplastic material shall be suitable for use on asphalt and hydraulic cement concrete pavement surfaces and shall be selected from the Materials Division’s Approved Products List No. 43.

The binder shall be either alkyd or hydrocarbon based. If an alkyd thermoplastic is used, the binder shall consist of synthetic resins, at least one of which is solid at room temperature, and high-boiling plasticizers. At least one-half of the binder composition shall be a maleic-modified glycerol ester of resin and shall be at least 10 percent by weight of the entire material formulation.

Thermoplastic marking materials shall be capable of application at pavement surface temperatures of 50 degrees Fahrenheit and above on all asphalt and hydraulic cement concrete pavement surfaces. Thermoplastic material shall be capable of successfully fusing to itself and previously applied thermoplastic pavement markings.

- 1. **Initial Approval** - Maintained retroreflectivity, color, luminance (Y%), and durability shall conform to the following requirements after the material has been installed on the test deck for 1 year:
  - a. **Maintained Retroreflectivity:** The photometric quantity to be measured is the coefficient of retroreflected luminance (R<sub>L</sub>) in accordance with ASTM E1710 for 30-meter geometry when measured in the skip line area.

**ORDER NO.: 247**  
**CONTRACT ID. NO.: CM224PMF123441B**

**Coefficient of Retroreflected Luminance (R<sub>L</sub>)  
(mcd/ft<sup>2</sup>/fc) Thermoplastic**

Color	Initial	1 Year In-Service
White	300	250
Yellow	250	200

- b. **Day and Nighttime Color and Luminance (Y%):** According to ASTM D6628
- c. **Durability:** Thermoplastic shall have a durability rating of at least 8 as determined in the wheel path area when tested in accordance with the NTPEP Work Plan.
- d. **Skid Resistance:** The initial skid resistance shall be at least 45 BPN when tested per ASTM E303, if available.

**2. Batch Testing:**

Thermoplastic batch testing will be performed by the Department on samples obtained from the point of manufacture or from the field in accordance with the Materials Division's Manual of Instructions. The tests results will be compared against the following specifications and requirements:

- a. **Pigment and Glass Bead (% Weight)** according to ASTM D4451 82.0% Max
- b. **Intermix Glass Bead Content (% Weight)** according to AASHTO T 250 and ASTM D4797 30.0% Min
- c. **TiO<sub>2</sub> (%) for white thermoplastic** according to ASTM D1394 or equivalent method 10.0% Min
- d. **Binder (%)** according to AASHTO T 250/ASTM D4451 18.0% Min
- e. **Calcium Carbonate and Inert Fillers** 42.0 % Max
- f. **Day Color, Luminance (Y%) (Without Drop-on Beads):** Color testing results shall conform to the chromaticity coordinate limits that follow. Color determination for thermoplastic materials will be made without drop-on beads after cooling in accordance with AASHTO T 250 and ASTM D6628.

**Day Color, Chromaticity Coordinates (Without Drop-on Beads), Thermoplastic**

	x	y	x	y	x	y	x	y	Y%
White	0.355	0.355	0.305	0.305	0.285	0.325	0.335	0.375	80.0 Min
Yellow	0.499	0.466	0.545	0.455	0.518	0.432	0.485	0.454	40.0-60.0

- g. **Nighttime Yellow Color (with Drop-on Beads):** The initial nighttime color of yellow thermoplastic pavement marking material shall conform to the following CIE chromaticity coordinate requirements when tested in accordance with ASTM D6628 and VTM-111:.

**Night Time Color, Chromaticity Coordinates (with Drop-on Beads) Thermoplastic**

Color	1		2		3		4	
	x	y	x	y	x	y	x	y
Yellow	0.486	0.439	0.520	0.480	0.560	0.440	0.498	0.426

- h. **Water absorption:** Materials shall not have more than 0.5 percent retained water by weight when tested in accordance with ASTM D570, Procedure A.

**ORDER NO.: 247**  
**CONTRACT ID. NO.: CM224PMF123441B**

- i. **Softening point:** Materials shall have a softening point of at least 194 degrees F as determined in accordance with ASTM E28.
- j. **Specific gravity:** The specific gravity of the thermoplastic compound at 77 degrees F shall be from 1.7 to 2.2.
- k. **Impact resistance:** The impact resistance shall be at least 10 inch-pounds at 77 degrees F after the material has been heated for 4 hours at 400 degrees F and cast into bars of 1-inch cross-sectional area, 3 inches long, and placed with 1 inch extending above the vise in a cantilever beam, Izod-type tester conforming to ASTM D256 using the 25 inch-pound scale.
- l. **No-Track Time:** Material shall set to bear traffic in not more than 2 minutes when the road temperature is 50 degrees F or above.
- m. **Intermixed Glass beads:** Glass beads shall conform to Section 234.
- n. **Flashpoint:** The material flashpoint shall be no less than 500 degrees F when tested in accordance with ASTM D92.

**Section 246.03(c) Preformed Thermoplastic Pavement Marking Material (Type B, Class II)** is renumbered as 246.03(d).

**Section 246.03(d)1 Initial approval** is amended to replace the first paragraph with the following:

Maintained retroreflectivity, color, luminance (Y%), and durability shall conform to the following requirements after the material has been installed on the test deck for 1 year:

**Section 246.03(d) Epoxy-Resin Pavement Marking Material (Type B, Class III)** is renumbered as 246.03(e).

**Section 246.03(e)1 Initial approval** is amended to replace the first paragraph with the following:

Maintained retroreflectivity, color, luminance (Y%), and durability shall conform to the following requirements after the material has been installed on the test deck for 1 year:

**Section 246.03(e) Polyurea Pavement Marking Material (Type B, Class VII)** is renumbered as 246.03(f).

**Section 246.03(f)1 Initial approval** is amended to replace the first paragraph with the following:

Maintained retroreflectivity, color, luminance (Y%), and durability shall conform to the following requirements after the material has been installed on the test deck for 1 year:

**Section 246.03(f) Permanent, Plastic-Backed, Preformed Tapes (Type B, Class IV and Type B, Class VI)** is renumbered as 246.03(g).

**Section 246.03(g)1 Initial approval** is amended to replace the first paragraph with the following:

Maintained retroreflectivity, color, luminance (Y%), durability, and adhesion shall conform to the following requirements after the material has been installed on the test deck for 1 year:

**ORDER NO.: 247**  
**CONTRACT ID. NO.: CM224PMF123441B**

Section 246.03(g) – Temporary Pavement Marking Materials is renumbered as 246.03(h) and replaced with the following:

**Temporary Pavement Marking Materials** other than paint shall consist of Type D, Class III, removable, wet reflective tape and Type E removable black, non-reflective tape. Determination of conformance will include, but not be limited to, the evaluation of test data from AASHTO's NTPEP or other VDOT Test Facilities.

**IV. 1. Wet Reflective, Removable Tape (Type D, Class III):**

V. Wet reflective, removable tape shall be a durable, retro-reflective pliant material consisting of a mixture of polymeric materials, pigments, and glass beads (reflective optics) evenly distributed throughout its cross-sectional area and embedded into the surface. This tape shall be suitable for use on both asphalt and hydraulic cement concrete surfaces and shall be selected from the Department's Approved List 17.

a. **Initial Approval** - Maintained retroreflectivity (dry and wet), color, luminance (Y%), and adhesive bond rating shall conform to the following requirements after the material has been installed on the test deck for 90 days:

(1) **Maintained Dry Retroreflectivity:** The dry photometric quantity to be measured is the coefficient of retroreflected luminance (R<sub>L</sub>) in accordance with ASTM E1710 for 30-meter geometry when measured in the skip line or centerline areas.

**Coefficient of Retroreflected Luminance (R<sub>L</sub>) (mcd/ft<sup>2</sup>/fc) Dry Retro Removable Tape-Type D, Class III**

Color	Initial	90 Days In-Service
White	250	150
Yellow	200	100

(2) **Maintained Wet Retroreflectivity:** The wet photometric quantity to be measured is the coefficient of retroreflected luminance (R<sub>L</sub>) in accordance with VTM 124 (Visual Evaluation or ASTM E2177, Recovery Method) when measured in the skip line or centerline areas.

**Coefficient of Retroreflected Luminance (R<sub>L</sub>) (mcd/ft<sup>2</sup>/fc) Wet Retro Removable Tape-Type D, Class III**

Color	Initial	90 Days In-Service
White	150	100
Yellow	125	75

(3) **Day and Nighttime Color and Luminance (Y%):** According to ASTM D6628.

(4) **Adhesive Bond Rating:** The average adhesive bond rating (from transverse and longitudinal lines) shall be 3 or higher according the NTPEP Work Plan.

(5) **Skid Resistance:** The initial skid resistance shall be at least 45 BPN when tested according to ASTM E303, if available.

(6) **Thickness:** Per the manufacturer's recommendation.

(7) **Adhesion:** No line shall be displaced, torn or missing.

b. **Batch Testing:**



**ORDER NO.: 247**  
**CONTRACT ID. NO.: CM224PMF123441B**

Wet reflective, removable tape batch testing will be performed by the Department on samples obtained from the point of manufacture or from the field in accordance with the Materials Division's Manual of Instructions. Test results shall be compared against the following specifications and requirements:

- (1) **Retroreflectivity:** Refer to initial requirements
- (2) **Day and Night Color and Luminance:** Refer to initial requirements
- (3) **Thickness:** Refer to initial requirements
- (4) **Width:** The width shall be no less than the nominal width and no greater than 1/8" of the nominal width.
- (5) **Length:** The length shall be no less than the length stated on the manufacturer's packaging.
- (6) **Skid Resistance:** Refer to initial requirements.

**2. Removable Black, Non-Reflective Tape (Type E):**

Removable black, non-reflective tape shall be a durable, pliant material consisting of a mixture of polymeric materials, pigments and a friction material evenly distributed throughout its cross-sectional area and embedded into the surface. Removable black, non-reflective tape shall be suitable for use on asphalt concrete pavement surfaces, and shall be selected from the Department's Approved List 17.

a. **Initial Approval** - Maintained adhesive bond rating shall conform to the following requirements after the material has been installed on the test deck for 90 days:

- (1) **Adhesive Bond Rating:** The average adhesive bond rating (from transverse and longitudinal lines) shall be 3 or higher according to the NTPEP Work Plan.
- (2) **Skid Resistance:** The initial skid resistance shall be at least 45 BPN when tested according to ASTM E303, if available.
- (3) **Thickness:** Per the manufacturer's recommendation.
- (4) **Adhesion:** No line shall be displaced, be torn or missing.

b. **Batch Testing**

Black removable, non-reflective tape batch testing will be performed by the Department on samples obtained from the point of manufacture or from the field in accordance with the Materials Division's Manual of Instructions. Test results shall be compared against the following specifications:

- (1) **Skid Resistance:** Refer to initial requirements
- (2) **Thickness:** Refer to initial requirements
- (3) **Width:** The width shall be no less than the nominal width and no greater than 1/8" of the nominal width.

**ORDER NO.: 247**  
**CONTRACT ID. NO.: CM224PMF123441B**

- (4) **Length:** The length shall be no less than the length stated on the manufacturer's packaging.

**ORDER NO.: 247**  
**CONTRACT ID. NO.: CM224PMF123441B**

SS248-002020-01

May 26, 2023

**VIRGINIA DEPARTMENT OF TRANSPORTATION**  
**2020 ROAD AND BRIDGE SUPPLEMENTAL SPECIFICATIONS**  
**SECTION 248 – STONE MATRIX ASPHALT CONCRETE**

**SECTION 248 – STONE MATRIX ASPHALT CONCRETE** of the Specifications is amended as follows:

**248.02 – Materials (f) is amended by replacing the first paragraph with the following:**

**Antistripping Additive:** An antistripping additive shall be used in all stone matrix asphalt mixes. It may be hydrated lime or a chemical additive from the Materials Division's Approved List No. 7, or a combination of both. When an approved chemical additive is used, it shall be added at a rate of not less than 0.30 percent by weight of the total asphalt content of the mixture unless otherwise indicated on the Department's Approved List No. 7.

**Section 248.04 Acceptance is amended by replacing the third, fourth, fifth, sixth paragraphs with the following:**

The Contractor shall check and report the percentage of flat and elongated particles (F&E) in the coarse aggregates of the mix design during production. Two of eight sub-lots from the first lot of material shall be selected for F&E verification when the Contractor samples the SMA material for acceptance (gradation and AC content). F&E testing shall be performed in accordance with VTM-121, after the gradation is performed. If passing results are obtained on each sample in the first lot, then F&E testing shall be performed on a frequency of every second lot of material produced (i.e., Lots 3, 5, 7, etc.) by randomly selecting two sub-lots. If the F&E of the mix exceeds the specified limits, the Contractor shall stop production and notify the Engineer. Production shall not resume until the Contractor has taken corrective action and the Engineer has accepted the Contractor's means of correction. Once production has resumed, the Contractor shall determine the F&E of the mix for two consecutive lots by randomly selecting two sub-lots per lot. If passing results are obtained for these two lots, then the F&E testing frequency shall return to every second lot of material produced.

The Contractor shall check and report the VCA of the mix during production for each gyratory sample. If the VCA of the mix equals the VCA of the DRC, the Contractor shall immediately notify the Engineer, document the JMF changes in the Producer Lab Analysis and Information Details (PLAID) website, and provide corrective action. If the VCA of the mix exceeds the VCA of the DRC, the Contractor shall stop production, notify the Engineer, and remove and replace that day's production at no cost to the Department. Production shall not resume until the Contractor has taken corrective action and the Engineer has accepted the Contractor's means of correction.

If the Department determines that the mixture being produced does not conform to the approved job-mix formula or the volumetric properties in Table II-25, based on the Department or the Contractor's test results, the Contractor shall immediately make corrections to bring the mixture into conformance with the approved job-mix formula and Table II-25 or cease paving with that mixture. The Engineer will investigate and determine the acceptability of the mix placed since the previous passing sample.

The finished pavement shall be uniform, free of irregularities and smooth. If irregularities including segregation, rutting, raveling, flushing, fat spots, mat slippage, irregular color, irregular texture, roller marks, tears, gouges, streaks, uncoated aggregate particles, or broken aggregate particles are detected, the Contractor shall immediately notify the Engineer and address the determined irregularities with corrective action. When irregularities are noted, the acceptability of the finished mat shall be determined by the Engineer.

**ORDER NO.: 247**  
**CONTRACT ID. NO.: CM224PMF123441B**

The Engineer will limit subsequent paving operations using either a revised or another job-mix formula, which has not been verified as described herein, to a test run of 300 tons maximum if such material is to be placed in Department project work. The Engineer will not allow any further paving for the Department using that revised mixture until the acceptability of that mixture has received the Engineer's approval based on the 300-ton constraint.

**ORDER NO.: 247**  
**CONTRACT ID. NO.: CM224PMF123441B**

SS315-002020-04

June 16, 2023

VIRGINIA DEPARTMENT OF TRANSPORTATION  
2020 ROAD AND BRIDGE SUPPLEMENTAL SPECIFICATIONS  
SECTION 315 – ASPHALT CONCRETE PLACEMENT

**SECTION 315 – ASPHALT CONCRETE PLACEMENT of the Specifications is replaced with the following:**

**315.01 – Description**

This work shall consist of constructing one or more courses of asphalt concrete on a prepared foundation in accordance with these Specifications and within the specified tolerances for the lines, grades, thicknesses, and cross sections shown on the plans or established by the Engineer. At the Contractor's option, the asphalt concrete mix may be produced using a warm-mix additive or warm-mix process approved by the Department. When used, the temperature placement limitations for Warm Mix Asphalt (WMA) shall apply.

This work shall also consist of constructing asphalt concrete curb and rumble strips in accordance with these Specifications, plan details, and the Standard Drawings.

**315.02 – Materials**

- (a) **Asphalt concrete** shall conform to Section 211. The Contractor shall alter the design if SUPERPAVE design densities begin to exceed 98 percent of the Theoretical Maximum Density (TMD) during construction.
- (b) **Asphalt for Tack Coat** shall conform to Section 210 and shall be applied according to Section 310.
- (c) **Asphalt for prime coat** shall conform to Section 210 and shall be applied according to Section 311.
- (d) **Curb backup material** shall be asphalt concrete conforming to any surface or intermediate mixture listed in Table II-13 and Table II-14.
- (e) **Liquid asphalt coating (emulsion) for rumble strips** shall conform to Section 210. The Contractor shall use CSS-1h or CQS-1h asphalt emulsions for centerline rumble strips. The CSS-1h or CQS-1h liquid asphalt may be diluted by up to 30 percent at the emulsion manufacturer's facility.

**315.03 – Equipment**

- (a) **Hauling Equipment:** Trucks used for hauling asphalt mixtures shall have structurally sound, tight, clean, smooth metal or other non-absorptive, inert material bodies equipped with a positive locking metal tailgate. Surfaces in contact with asphalt mixtures shall be given a thin coat of aliphatic hydrocarbon invert emulsion release agent (nonpuddling), a lime solution, or other release agent materials on the Materials Division's Approved List No. 8. The beds of dump trucks shall be raised to remove excess release agent prior to loading except when a nonpuddling release agent is used. Only a nonpuddling agent shall be used in truck beds that do not dump. Each Contractor truck used for hauling asphalt shall be equipped with a tarpaulin or other type of cover acceptable to the Engineer that shall protect the mixture from moisture and foreign matter and prevent the rapid loss of heat during transportation.
- (b) **Asphalt Pavers:** The asphalt paver shall be designed and recommended by the Manufacturer for the type of asphalt to be placed and shall be operated in accordance with the Manufacturer's recommendations. The Contractor shall readily have and maintain on the project site any written

**ORDER NO.: 247**  
**CONTRACT ID. NO.: CM224PMF123441B**

recommendations from the Manufacturer of the mix relative to handling and placing of the mixture. In the absence of the Manufacturer's recommendations, the recommendations of the National Asphalt Pavement Association shall be followed. The paver shall be capable of producing a smooth uniform texture, dense joints, and a smooth riding surface even when screed extensions are used.

- (c) **Rollers:** Rollers shall be steel wheel, static or vibratory, or pneumatic tire rollers and shall be capable of reversing without backlash. The Contractor shall operate rollers at speeds slow enough to avoid displacement of the mixture. The number and weight of rollers shall be sufficient to compact the mixture to the required density while it is still in a workable condition. The Engineer will not allow the use of equipment that results in excessive crushing of aggregate or marring of the pavement surface. If the Contractor's equipment mars the surface of the pavement during construction to the extent that imperfections cannot satisfactorily be corrected or produces permanent blemishes, the Engineer will require the Contractor to discontinue the use of that particular equipment and replace that equipment with satisfactory units.
- (d) **Rotary Saw:** The Contractor shall supply a gasoline-powered rotary saw with a carbide blade for cutting test samples from the pavement. The Contractor shall provide gasoline, oil, additional carbide blades, and maintenance for the rotary saw. The Contractor shall cool the pavement prior to sawing the sample. As an alternative, the Contractor may furnish the necessary equipment for coring and testing 4-inch core samples in accordance with VTM-22.
- (e) **Material Transfer Vehicle (MTV):** When required in the Contract, the Contractor shall furnish a self-propelled MTV storage unit capable of receiving material from trucks, storing the material, and transferring the material from the unit to a paver hopper insert via a conveyor system. The paver hopper insert and unit shall have a combined minimum storage capacity of 15 tons. The storage unit or paver hopper insert must be able to remix the material in order to produce a uniform, non-segregated mix having a uniform temperature prior to placing the asphalt material on the roadway surface.

**315.04 – Placement Limitations**

The Contractor shall not place asphalt concrete mixtures when weather or surface conditions are such that the material cannot be properly handled, finished, or compacted. The surface upon which asphalt mixtures is to be placed shall be free of standing water, dirt, and mud and the base temperature shall conform to the following:

**(a) Asphalt Concrete Produced with Warm Mix Asphalt Additives or Processes:**

The Contractor shall note on the delivery ticket that the load is Warm Mix Asphalt.

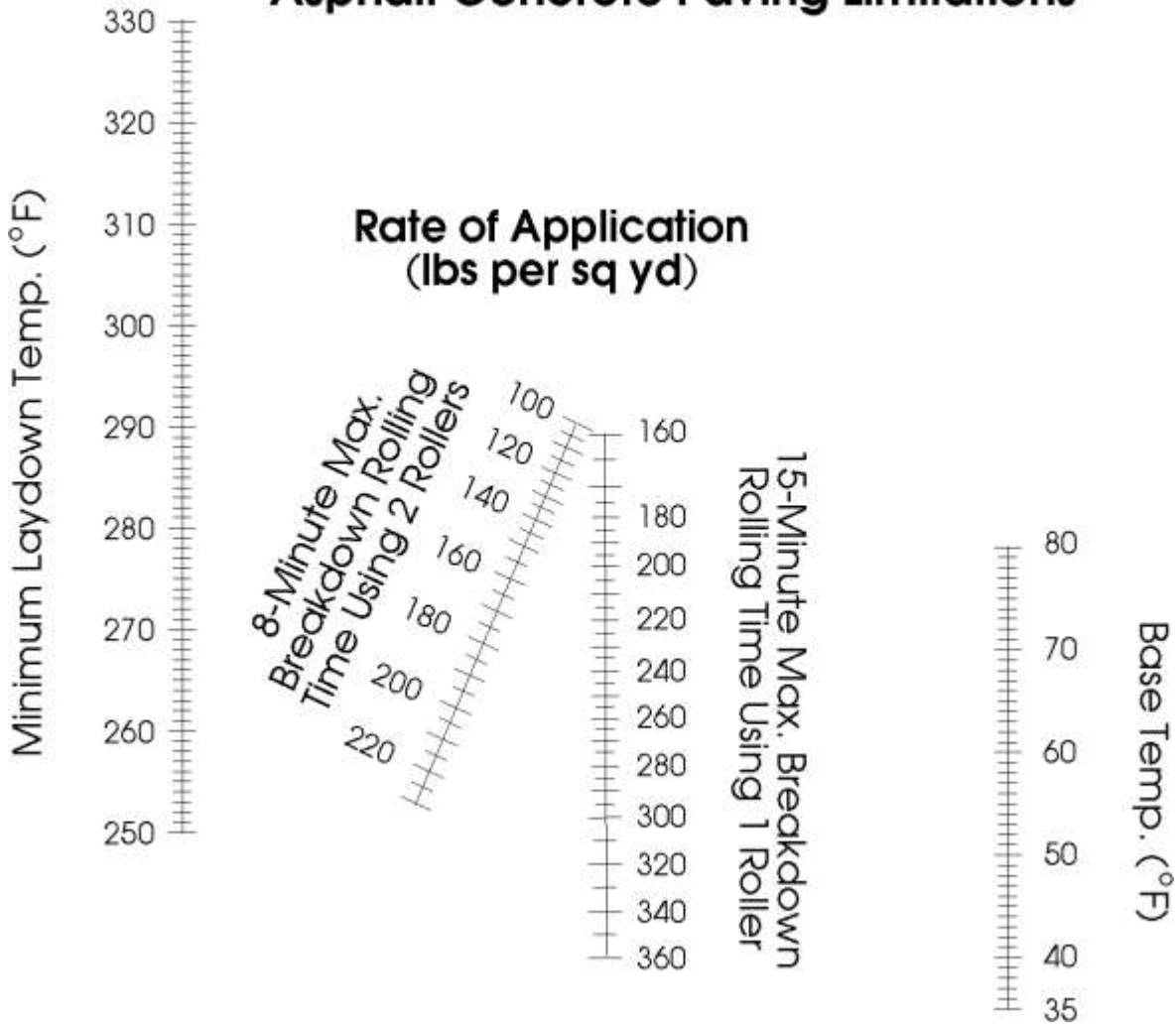
- 1. **When the base temperature is 40 degrees F and above:** The Engineer will permit lay-down at any temperature below the maximum limits given in Section 211.08.
- 2. **When the mixture temperature is below 200 degrees F:** The Contractor will not be allowed to place the material.

**(b) Asphalt Concrete Produced without Warm Mix Asphalt Additives or Processes:**

- 1. **When the base temperature is above 80 degrees F:** The Engineer will allow laydown of the mixture at any temperature conforming to the limits specified in Section 211.
- 2. **When the base temperature is between 40°F and 80°F** the Contractor shall use Table III-2 to determine the minimum laydown temperature of the asphalt concrete mixes. At no time shall the base temperature for base (BM) and intermediate (IM) mixes be less than 40°F. At no time shall the laydown temperature for BM and IM mixes be less than 250°F.

TABLE III-2  
 Cold Weather Paving Limitations

### Asphalt Concrete Paving Limitations



The minimum base and laydown temperatures for surface mixes (SM) shall never be less than the following:

PG Binder/Mix Designation	Percentage of Reclaimed Asphalt Pavement (RAP) Added to Mix	Minimum Base Temperature	Minimum Placement Temperature
PG 64S-22 (A)	<=25%	40°F	250°F
PG 64S-22 (A)	>25%	50°F <sup>2</sup>	270°F <sup>2</sup>
PG 64H-22 (D)	<=30%	50°F <sup>2</sup>	270°F <sup>2</sup>
PG 64E-22 (E)	<=15%	50°F <sup>2</sup>	290°F <sup>2</sup>
PG 64S-22 (S)	<=30%	50°F <sup>2</sup>	290°F <sup>2</sup>

**ORDER NO.: 247**  
**CONTRACT ID. NO.: CM224PMF123441B**

3. **When the laydown temperature is between 301 degrees F and 325 degrees F:** The number of compaction rollers shall be the same number as those required for 300 degrees F.

Intermediate and base courses that are placed at rates of application that exceed the application rates shown in Table III-2 shall conform to the requirements for the maximum application rate shown for 8-minute and 15-minute compaction rolling as per number of rollers used.

If the Contractor is unable to complete the compaction rolling within the applicable 8-minute or 15-minute period, the Engineer will either require the placing of the asphalt mixture to cease until sufficient rollers are used or other corrective action be taken to complete the compaction rolling within the specified time period.

The Contractor shall complete compaction rolling prior to the mat cooling down to 175 degrees F. Finish rolling may be performed at a lower mat temperature.

The Contractor shall not place the final asphalt pavement finish course until temporary pavement markings will no longer be required.

**(c) SM-4.75 Mixtures Placement:**

1. The minimum placement temperature shall be 290°F regardless of WMA use.
2. The minimum ambient and base temperature shall be 50°F. The Contractor shall employ a MTV during the placement of SM-4.75 mixtures when either the ambient or base temperature is between 50°F and 60°F.

**315.05 – Procedures**

- (a) **Base Course:** The Contractor shall prepare the subgrade or subbase as specified in Section 305. The Contractor shall grade and compact the course to the required profile upon which the pavement is to be placed, including the area that will support the paving equipment.
- (b) **Conditioning Existing Surface:** The surface on which the asphalt concrete is to be placed shall be prepared in accordance with the applicable specifications and shall be graded and compacted to the required profile and cross section.

When specified in the Contract, before placement of asphalt concrete, the Contractor shall seal longitudinal and transverse joints and cracks by the application of an approved crack sealing material in accordance with Section 322.

1. **Priming and Tacking:** The Contractor shall paint contact surfaces of curbing, gutters, manholes, and other structures projecting into or abutting the pavement and cold joints of asphalt with a thick, uniform coating of asphalt prior to placing the asphalt mixture.

The Contractor shall apply a tack or prime coat of asphalt conforming to the applicable requirements of Section 311 or Section 310 and as specified below. Liquid asphalt classified as cutbacks or emulsions shall be applied ahead of the paving operations, and the time interval between applying and placing the paving mixture shall be sufficient to ensure a tacky residue has formed to provide maximum adhesion of the paving mixture to the base. The Contractor shall not place the mixture on tack or prime coats that have been damaged by traffic or contaminated by foreign material. Traffic shall be excluded from such sections.

- a. **Priming aggregate base or subbase:** The Engineer will not require priming with asphalt material on aggregate subbase or base material prior to the placement of asphalt base, intermediate or surface layers unless otherwise specified in the Contract.



**ORDER NO.: 247**  
**CONTRACT ID. NO.: CM224PMF123441B**

- b. **Tacking:** Tack at joints, adjacent to curbs, gutters, or other appurtenances shall be applied with a hand wand or with spray bar at the rate of 0.2 gallon per square yard. At joints, the tack applied by the hand wand or a spray bar shall be 2 feet in width with 4 to 6 inches protruding beyond the joint for the first pass. Tack for the adjacent pass shall completely cover the vertical face of the pavement mat edge so that slight puddling of asphalt occurs at the joint, and extend a minimum of 1 foot into the lane to be paved. Milled faces that are to remain in place shall be tacked in the same way for the adjacent pass. Use of tack at the vertical faces of longitudinal joints will not be required when paving is performed in echelon.

The tack coat shall be eliminated on asphalt saturated (rich) sections or those that have been repaired by the extensive use of asphalt patching mixtures when directed by the Engineer.

Tack shall not be required atop asphalt stabilized open-graded material drainage layers.

Tack shall be applied between the existing asphalt surface and each asphalt course placed thereafter.

2. **Removing depressions and elevating curves:** Where irregularities in the existing surface will result in a course more than 3 inches in thickness after compaction, the Contractor shall bring the surface to a uniform profile by patching with asphalt concrete and thoroughly tamping or rolling the patched area until it conforms with the surrounding surface. The mixture used shall be the same as that specified for the course to be placed.

When the Contractor elects to conduct operations to eliminate depressions, elevate curves, and place the surface course simultaneously, the Contractor shall furnish such additional spreading and compacting equipment as required to maintain the proper interval between the operations.

- (c) **Placing and Finishing:** The Contractor shall not place asphalt concrete until the Engineer approves the surface upon which it is to be placed.

The Contractor's equipment and placement operations shall properly control the pavement width and horizontal alignment. The Contractor shall use an asphalt paver sized to distribute asphalt concrete over the widest pavement width practicable. Wherever practicable, and when the capacity of sustained production and delivery is such that more than one paver can be successfully and continuously operated, pavers shall be used in echelon to place the wearing course in adjacent lanes. Crossovers, as well as areas containing manholes or other obstacles that prohibit the practical use of mechanical spreading and finishing equipment may be constructed using hand tools. However, the Contractor shall exercise care to obtain the required thickness, jointing, compaction, and surface smoothness in such areas.

The longitudinal joint in one layer shall offset that in the layer immediately below by approximately 6 inches or more. The joint in the wearing surface shall be offset 6 inches to 12 inches from the centerline of the pavement if the roadway comprises two traffic lanes. The joint shall be offset approximately 6 inches from the lane lines if the roadway is more than two lanes in width. The longitudinal joint shall be uniform in appearance. If the offset for the longitudinal joint varies from a straight line more than 2 inches in 50 feet on tangent alignment, or from a true arc more than 2 inches in 50 feet on curved alignment, the Contractor shall seal the joint using a water-proof sealer at no cost to the Department. The Contractor shall recommend a sealant and installation procedure to the Engineer for approval before proceeding. If the offset for the longitudinal joint varies from a straight line more than 3 inches in 50 feet on tangent alignment, or from a true arc more than 3 inches in 50 feet on curved alignment, the Engineer may reject the paving. The Engineer will not require offsetting layers when adjoining lanes are paved in echelon and the rolling of both lanes occurs within 15 minutes after laydown.

The Contractor shall have a certified Asphalt Field Level II Technician present during all paving operations. Immediately after placement and screeding, the surface and edges of each layer shall be inspected by the Asphalt Field Level II Technician to ensure compliance with the asphalt placement requirements and be straightedged to verify uniformity and smoothness. The Asphalt Field Level II Technician shall make any corrections to the

**ORDER NO.: 247**  
**CONTRACT ID. NO.: CM224PMF123441B**

placement operations, if necessary, prior to compaction.. The finished pavement shall be uniform and free of irregularities. If irregularities, including but not limited to segregation or flushing, are identified during the paving operation, the Contractor shall immediately notify the Engineer and address the irregularities with corrective action. If the irregularities continue, the Contractor shall cease the paving operation and not resume until corrective measures have been approved by the Department. When irregularities are noted, the limits of the finished mat shall be determined by the Engineer. The limits of the deficient area of the finished mat shall be removed and replaced at no cost to the Department. The Contractor's Asphalt Field Level II Technician shall be present during all density testing.

Asphalt concrete placement shall be as continuous as possible and shall be scheduled such that the interruption occurring at the completion of each day's work shall not detrimentally affect the partially completed work. Material that cannot be spread and finished in daylight shall not be dispatched from the plant unless the Engineer approves the use of artificial lighting. When paving is performed at night, the Contractor shall provide sufficient light to properly perform and thoroughly inspect every phase of the operation. Such phases include cleaning planed surfaces, applying tack, paving, compacting, and testing. Lighting shall be provided and positioned so as to not create a blinding hazard to the traveling public.

The Contractor shall ensure that the roller does not pass over the end of freshly placed material during the compaction of asphalt concrete except when a transverse construction joint is to be formed. Edges of pavement shall be finished true and uniform.

Asphalt concrete SUPERPAVE pavement courses shall be placed in layers not exceeding five times the Nominal Maximum Aggregate Size (NMAS) in the asphalt concrete. The maximum thickness may be reduced if the mixture cannot be adequately placed in a single lift and compacted to the required uniform density and smoothness. The minimum thickness for a pavement course shall be no less than 2.5 times the NMAS of the asphalt concrete. The NMAS for each mix shall be defined as one sieve size larger than the first sieve to retain more than 10 percent aggregate as shown in the design range specified in Section 211.03, Table II-13. The Contractor may place base courses in irregularly shaped areas of pavement such as transitions, turn lanes, crossovers, and entrances in a single lift.

The Contractor shall square up overlays in excess of 220 pounds per square yard or lanes with a milled depth greater than 2 inches prior to opening to traffic.

The Contractor shall cut drainage outlets through the shoulder at locations the Engineer designates, excluding curb and gutter sections, on the milled roadway areas that are to be opened to traffic. Plan and prosecute the milling operation to avoid trapping water on the roadway and restore drainage outlets to original grade once paving operations are completed, unless otherwise directed by the Engineer. The cost for cutting and restoring the drainage slots in the roadway shoulder shall be included in the price bid for other items of work.

The Contractor shall plan and prosecute a schedule of operations so that milled roadways shall be overlaid with asphalt concrete as soon as possible. In no instance shall the time lapse exceed 14 days after the milling operations, unless otherwise specified in Section 515 or other provisions in the contract. The Contractor shall keep milled areas of the roadway free of irregularities and obstructions that may create a hazard or annoyance to traffic in accordance with Section 104.

The Contractor shall use a short ski or shoe to match the grade of the newly overlaid adjacent travel lane on primary, interstate, and designated secondary routes. Unless otherwise directed by the Engineer, a 24-foot minimum automatic grade control ski shall be used on asphalt mixtures on divided highways, with the exception of overlays that are less than full width and the first course of asphalt base mixtures over aggregate subbases. Care shall be exercised when working along curb and gutter sections to provide a uniform grade and joint.

**ORDER NO.: 247**  
**CONTRACT ID. NO.: CM224PMF123441B**

The Contractor shall construct the final riding surface to tie into the existing surface by an approved method, which shall include the cutting of a notch into the existing pavement. In addition to notching, the Contractor may use an asphalt mix design containing a fine-graded mix to achieve a smooth transition from the new asphalt concrete overlay to the existing pavement, with the approval of the Engineer. The material shall be of a type to ensure that raveling will not occur. The cost for constructing tie-ins in the asphalt concrete overlay shall be included in the asphalt concrete contract unit price.

Prior to application of tack coat and commencement of paving operations if, in the opinion of the Engineer, the existing pavement surface condition may detrimentally affect or prevent the bond of the new overlay, the Contractor shall clean the existing pavement surface of all accumulated dust, mud, or other debris. At no point shall soil, aggregate, or other potential bond breaker material be stored on the pavement surface, unless otherwise approved by the Engineer. If the Contractor wishes to stockpile materials on the pavement surface, the Contractor shall provide documentation to the Engineer for approval on the means and methods that will be used to ensure it will not detrimentally affect or prevent the bond of the next pavement layer. This includes all base, intermediate and surface asphalt layers.

The Contractor shall ensure the surface remains clean until commencement of, and during, paving operations. The cost for cleaning and surface preparation shall be included in the asphalt concrete contract unit price.

The Contractor shall employ a Material Transfer Vehicle (MTV) during the placement of surface mixes (SM) on all Interstate routes. If equipment within the paving train breaks down, paving shall be discontinued once the material on-site has been placed and no more material shall be shipped from the asphalt plant.

When required in the Contract, a MTV shall be used during the placement of designated asphalt mixes on full lane width applications.

- (d) **Compacting:** Immediately after the asphalt mixture is placed, struck off, and surface irregularities are corrected, the mixture shall be thoroughly and uniformly compacted by rolling. Rolling shall be a continuous process, insofar as practicable, and all parts of the pavement shall receive uniform compaction.

The asphalt surface shall be rolled when the mixture is in the proper condition. Rolling shall not cause undue displacement, cracking, or shoving of the placed mixture.

The Contractor shall use the number, weight, and type of rollers sufficient to obtain the required compaction while the mixture is in a workable condition. The sequence of rolling operations and the selection of roller types shall provide the specified pavement density.

Rolling shall begin at the sides of the placement and proceed longitudinally parallel with the center of the pavement, each pass overlapping at least 6 inches, gradually progressing to the crown of the pavement. When abutting a previously placed lane, rolling shall begin at the outside unconfined side and proceed toward the previously placed lane. On superelevated curves, rolling shall begin at the low side and proceed to the high side by overlapping longitudinal passes parallel with the centerline.

The Contractor shall correct displacements occurring as a result of reversing the direction of a roller or other causes at once by the use of rakes or lutes and the addition of fresh mixture when required. Care shall be taken in rolling not to displace or distort the line and grade of the edges of the asphalt mixture. Edges of finished asphalt pavement surfaces shall be true curves or tangents. The Contractor shall correct irregularities in such areas.

The Contractor shall keep the wheels/drums of the rollers properly moistened with water, water mixed with a very small quantity of detergent or other Engineer approved material to prevent adhesion of the mixture to the rollers. The Engineer will not allow the use or presence of excess liquid on the rollers.

**ORDER NO.: 247**  
**CONTRACT ID. NO.: CM224PMF123441B**

The Contractor shall thoroughly compact the mixture along forms, curbs, headers, walls, and other places not accessible to rollers with hot hand tampers, smoothing irons, or mechanical tampers,. On depressed areas, a trench roller or cleated compression strips may be used under the roller to ensure proper compression.

For SM-4.75 mixes, breakdown rolling shall be accomplished with steel wheel rollers with a minimum weight of 10 tons. SM-4.75 mixes shall receive at least three breakdown roller passes before intermediate and finish rolling.

The Contractor shall protect the surface of the compacted course until the material has cooled sufficiently to support normal traffic without marring.

(e) **Density** will be determined in accordance with Method A for all interstate and limited access routes, and for primary and secondary routes with an ADT of at least 2,000 and at least 20 feet in width. Method B will be used for all other routes. Control Strips will not use Method A or B, but will use the methods described in Section 315.05(e)1a.

1. The Contractor shall perform roller pattern and control strip density testing on surface, intermediate, and base courses in accordance with VTM-76. The Contractor shall have a certified Asphalt Field Technician II perform all density testing.

Density shall be determined with a thin-lift nuclear gauge conforming VTM-81 or from the testing of plugs/cores taken from the roadway where the mixture was placed. Density test locations shall be marked and labeled in accordance with VTM-76. When acceptance testing is performed with a nuclear gauge, the Contractor shall have had the gauge calibrated within the previous 12 months by an approved calibration service. In addition, the Contractor shall maintain documentation of such calibration service for the 12-month period from the date of the calibration service. The required density of the compacted course shall not be less than 98.0 percent or more than 102.0 percent of the target control strip density.

Nuclear density roller pattern and control strip density testing shall be performed on asphalt concrete overlays placed directly on surface treatment roadways and when overlays are placed at an application rate less than 125 pounds per square yard, based on 110 pounds per square yard per inch, on any surface. In these situations, the Engineer will not require sawed plugs or core samples and the minimum control strip density of 92.5 of TMD will not be required. The required density of the compacted course shall not be less than 98.0 percent or more than 102.0 percent of the target control strip.

The Engineer will divide the project into "control strips" and "test sections" for the purpose of defining areas represented by each series of tests.

- a. **Control Strip:** Control strips shall be constructed in accordance with these specifications and VTM-76.

The term *control strip density* is defined as the average of 10 determinations selected at stratified random locations within the control strip.

The Contractor shall construct one control strip at the beginning of work on each roadway and shoulder course and on each lift of each course. The Engineer will require the Contractor to construct an additional control strip whenever a change is made in the type or source of materials; whenever a significant change occurs in the composition of the material being placed from the same source; or when there is a failing test strip. During the evaluation of the initial control strip, the Contractor may continue paving operations, however, paving and production shall be discontinued during construction and evaluation of any additional control strips. If two consecutive control strips fail, subsequent paving operations shall not begin or shall cease until

**ORDER NO.: 247**  
**CONTRACT ID. NO.: CM224PMF123441B**

the Contractor recommends correctives actions to the Engineer and the Engineer approves the Contractor proceeding with the corrective action(s). If the Contractor and the Engineer mutually agree that the required density cannot be obtained because of the condition of the existing pavement structure, the target control strip density shall be determined from the roller pattern that achieves the optimum density and this target control strip density shall be used on the remainder of the roadway that exhibits similar pavement conditions.

Either the Engineer or the Contractor may initiate the construction of an additional control strip at any time.

The length of the control strip shall be approximately 300 feet and the width shall not be less than 6 feet. On the first day of construction or beginning of a new course, the control strip shall be started between 500 and 1,000 feet from the beginning of the paving operation. The Contractor shall construct the control strip using the same paving, rolling equipment, procedures, and thickness as shall be used for the remainder of the course being placed.

The Contractor's Asphalt Field Level II Technician shall take one reading at each of 10 stratified random locations. No determination shall be made within 12 inches of the edge of any application width for surface and intermediate mixes or within 18 inches of the edge of any application width for base mixes. The average of these 10 determinations shall be the control strip density recorded to the nearest 0.1 pound per cubic foot. The minimum control strip density shall be determined in accordance with VTM-76.

The control strip shall be considered a lot. If the control strip density conforms to the requirements of 92.5% of TMD for surface, intermediate and base mix, the Engineer will consider the control strip to be acceptable and the control strip density shall become the target control strip density.

If the Engineer determines that the control strip requirements of 92.5% of TMD for surface, intermediate and base mix cannot be met due to in-situ pavement conditions, Method 'B' will be used for acceptance and payment and density adjustments will be waived.

Otherwise, if the density does not conform to the requirements specified of 92.5% of TMD for surface, intermediate and base mix, the tonnage placed in the control strip and any subsequent paving prior to construction of another control strip will be paid for in accordance with Table III-3. If the control strip density is below 88% TMD, then that tonnage shall be removed from the roadway at no cost to the Department. At the discretion of the Engineer, the material may be accepted at 75% of the contract unit price. The Contractor shall take corrective action(s) to comply with the density requirement of a minimum of 92.5% of TMD.

**TABLE III-3**  
**Control Strip Requirement and Payment Schedule for SM, IM and BM mixes**

% TMD	% of Payment
Greater than 96.5 <sup>1</sup>	95
<b>92.5– 96.5<sup>1</sup></b>	<b>100</b>
90.0-92.4	90
88.0-89.9	80
Less than 88.0	Removal

<sup>1</sup> For Base Mix only, the range for 100% pay shall be 92.5-97.0% of TMD.

- b. **Test section (lot):** For the purposes of both Contractor quality control and determining acceptance, the Engineer will consider each day's production as a lot unless the paving length is less than 3,000 linear feet or more than 7,500 linear feet, regardless of the method of acceptance (Method A or B). When paving is less than 3,000 feet, that day's production will be

**ORDER NO.: 247**  
**CONTRACT ID. NO.: CM224PMF123441B**

combined with the previous day's production or added to the next day's production to create a lot as described below.

The standard size of a lot will be 5,000 linear feet (five 1,000 foot sublots) of any pass 6 feet or greater made by the paving train for the thickness of the course. If the Engineer approves, the lot size may be increased to 7,500 linear foot lots with five 1,500 foot sublots when the Contractor's normal daily production exceeds 7,000 feet. Pavers traveling in echelon will be considered as two passes. When a partial lot occurs at the end of a day's production or upon completion of the project, the lot size will be redefined as follows:

- If the partial lot contains one or two sublots, the sublots will be added to the previous lot.
- If the partial lot contains three or four sublots, the partial lot will be redefined to be an entire lot.

The Contractor shall test each lot for density by taking a nuclear density gauge reading from two random test sites selected by the Engineer within each sublot. When saw plugs or cores are used to determine acceptance, a single test site will be selected by the Engineer. Test sites will not be located within 12 inches of the edge of any application width for surface and intermediate mixes or within 18 inches of the edge of any application width for base mixes.

The Engineer will compare the average of the sublot density measurements to the target nuclear density, or for plugs and cores, to the target percent of theoretical maximum density achieved on the control strip to determine the acceptability of the lot. The Contractor shall immediately notify the Engineer and institute corrective action if two consecutive sublots produce density results less than 98% or more than 102% of the target control strip density.

Density testing for acceptance will not be performed on areas too thin or irregular to test accurately, such as open-graded friction courses, and wedge-and-leveling courses. Areas that are difficult to compact due to subgrade support or space limitations, including but not limited to crossovers and gore areas, will be placed in accordance with Section 315.05(e)2.

For purposes of density determination, acceptance, and payment, Main Pavement is defined to include travel lanes, shoulders 6 feet or greater, turn lanes, ramps, and acceleration and deceleration lanes.

**(1) Method 'A' (plugs or cores)**

Any pay adjustment will only be applied to Main Pavement.

The Contractor shall perform acceptance testing for density for each sublot by obtaining one plug, defined as a sawed 4-inch by 4-inch specimen, or one 4-inch-diameter core, at a single random test site selected by the Engineer. More than one plug or core can be taken if the original sample is damaged.

The sub-lot site shall be marked as described in VTM-76. The bulk specific gravity of the plugs or cores shall be determined in accordance with VTM-6. The density of the plugs or cores shall be determined in accordance with VTM-22, except that the daily Rice values obtained by the contractor for the mix will be used for calculating percent density (instead of using the 5-day running average as noted in VTM-22).

Plugs or cores shall be taken from the pavement during the paving shift and bulked in the presence of the Engineer unless otherwise approved. The Department reserves the right to have the plugs or cores bulked on the project site. In the event of any uncertainty around the bulking procedures or results, the Department further reserves the right to re-bulk the samples.

**ORDER NO.: 247**  
**CONTRACT ID. NO.: CM224PMF123441B**

The Contractor will have the right to witness the re-bulking. The Contractor will be responsible for maintaining the cores until approved for disposal by the Department.

The Contractor shall number subplot test sites sequentially per lot, mark these on the pavement, fill them with the paving mixture, and compact them prior to the completion of each day of production.

The Contractor shall clean and straighten any irregular edges before filling and compacting. Liquid tack material shall be applied so it visibly covers all plug or core hole surfaces (sides, bottom, etc.). Asphalt concrete mixture available on the same day of paving, or other permanent patching material as approved by the Engineer, shall be placed into the plug or core hole and compacted with a 10-pound weighted hand tool or greater compactive effort with rollers or other equipment available on-site and approved by the Engineer.

The tonnage of each lot for the pay adjustment will be based on the lot's width and length and the mixture application rate as designated in the Contract or as revised by the Engineer. Payment will be made in accordance with Table III-4A.

**TABLE III-4A**  
**Payment Schedule for Method A Lot Densities for SM, IM and BM mixes**

% TMD	% of Payment
Greater than 96.5 <sup>1</sup>	95
92.5 – 96.5 <sup>1</sup>	100
90.0–92.4	90
88.0 – 89.9	80
Less than 88.0	Removal

<sup>1</sup> For Base Mix only, the range for 100% pay shall be 92.5-97.0% TMD.

If a minimum of 80% of each test section lot's core/plug samples is no lower than 92.5% of TMD and the lot average results in 100% payment, then the Engineer will increase the unit bid price for AC mixture by 5%. BM-25.0D+0.4 and BM-25.0D+0.8 shall not be eligible for five percent pay increase. No increase will be applied if core/plug samples are cut outside of the paving shift unless otherwise approved by the Engineer; any applicable density pay reduction from Table III-4A may still apply.

If any subplot(s) are lower than 88.0% of TMD then those sublots shall be removed from the roadway at no cost to the Department. If the lot average is below 88.0% of TMD then that test section shall be removed from the roadway at no cost to the Department.

Longitudinal joints shall also be tested for density using a nuclear density gauge at each test site in the subplot. For surface and intermediate mixes, the edge of the gauge shall be placed within 4 inches of the joint. For base mixes, the edge of the gauge shall be placed within 6 inches of the joint. The Contractor shall not place the gauge over top of the joint. The joint density value shall be recorded. The Contractor shall report to the Engineer and institute corrective action if a single longitudinal joint density reading is less than 95% of the target control strip density. The Engineer will not use the values obtained from the joint readings in payment calculation. The Contractor shall furnish the test data developed during the day's paving to the Engineer by the end of the day's operations.

**(2) Method 'B' (nuclear gauge)**

Any pay adjustment will only be applied to Main Pavement.

**ORDER NO.: 247**  
**CONTRACT ID. NO.: CM224PMF123441B**

The Contractor shall test each lot for density by taking a nuclear density gauge reading from two random test sites selected by the Engineer within each subplot. Test sites will not be located within 12 inches of the edge of any application width for surface and intermediate mixes or within 18 inches of the edge of any application width for base mixes.

The Engineer will compare the average of the subplot density measurements to the target nuclear density, or for cores, to the target percent of theoretical maximum density achieved on the control strip to determine the acceptability of the lot. Once the average density of the lot has been determined, the Engineer will not allow the Contractor to provide additional compaction to raise the average. The Contractor shall immediately institute corrective action if two consecutive sublots produce density results less than 98% or more than 102% of the target control strip density.

Longitudinal joints shall also be tested for density using a nuclear density gauge at each test site in the subplot. For surface and intermediate mixes, the edge of the gauge shall be placed within 4 inches of the joint. For base mixes, the edge of the gauge shall be placed within 6 inches of the joint. The Contractor shall not place the gauge over top of the joint. The joint density value shall be recorded. The Contractor shall report to the Engineer and institute corrective action if a single longitudinal joint density reading is less than 95 percent of the target control strip density. The Engineer will not use the values obtained from the joint readings in payment calculation. The Contractor shall furnish the test data developed during the day's paving to the Engineer by the end of the day's operations.

The tonnage of each lot for the pay adjustment will be based on the lot's width and length and the mixture application rate as designated in the Contract or as revised by the Engineer. Payment will be made in accordance with the requirements of Table III-4B.



**ORDER NO.: 247**  
**CONTRACT ID. NO.: CM224PMF123441B**

**TABLE III-4B**  
**Payment Schedule for Method B Lot Densities**

% of Target Control Strip Density	% of Payment
Greater than 102.0	95
98.0 to 102.0	100
97.0 to less than 98.0	95
96.0 to less than 97.0	90
Less than 96.0, but (% of Target Control Strip Density x %TMD control strip cores) > 88%	75
Less than 96.0, and (% of Target Control Strip Density x %TMD control strip cores) ≤ 88%	Removal <sup>1</sup>

1. If any lot produces density results less than 96.0% of Target, and (%of Target Control Strip Density x % TMD control strip cores) ≤ 88%, then that lot shall be removed from the roadway at no cost to the Department.

**(3) Verification, Sampling, and Testing (VST)**

The Engineer at any time on any project may perform lot density verification testing regardless of whether Method A or B is being used for density acceptance. Lot density verification is performed by testing plugs or cores. The Contractor shall be responsible for taking plugs or cores for testing. The Engineer will perform verification testing of the plugs or cores.

On surface, intermediate, and base mixes, the Contractor shall take two plugs or cores per VST lot at locations selected by the Engineer. If the Engineer determines the density of the plugs or cores does not conform to the requirements for the lot in question or the same payment percentage determined by the Contractor's testing for that lot, then the Contractor may request additional sampling to be invoked. The Contractor shall take one additional plug or core from the remaining sublots. Payment for that lot, based on the results of the initial two plugs or cores or referee procedure, will be in accordance with the Table III-4A for Method A on the basis of the percentage of the theoretical maximum density or Table III-4B for Method B on the basis of the percentage of the control strip bulk density achieved.

2. **Surface, intermediate, and base courses** not having a sufficient quantity of material to run a roller pattern and control strip, and unique sections defined on the Plans or within the Contract that are 3500 feet or less and at least 6 feet in width shall be compacted to a minimum density of 92.5 percent as determined in accordance with VTM-22. The Contractor shall be responsible for cutting cores or sawing plugs for testing by the Department. One plug or core shall be obtained within the first 500 feet of small quantity paving and every 1000 feet thereafter for testing by the Department. Plug or core locations shall be randomly selected by the Engineer. If the density is determined to be less than the minimum, the Engineer will make payment in accordance with Table III-5.

**ORDER NO.: 247**  
**CONTRACT ID. NO.: CM224PMF123441B**

**TABLE III-5**  
**Payment Schedule for Surface, Intermediate and Base Courses (Not sufficient quantity to perform density roller pattern and control strip)**

% TMD	% of Payment
Greater than or equal to 92.5	100
90.0-92.4	90
88.0-89.9	80
Less than 88.0	Removal <sup>1</sup>

1. Removal shall be at no cost to the Department.

Any section in which a mixture (e.g., SM-9.0) is being placed at an application rate of less than 125 pounds per square yard (based on 110 pounds per square yard per inch) that does not have a sufficient quantity of material for a roller pattern and control strip shall be compacted by rolling a minimum of three passes with a minimum 8-ton roller. The Engineer will not require density testing.

For asphalt patching or paving widths narrower than 6 feet in width, the minimum density of 91.5 percent of the maximum theoretical density will be determined in accordance with VTM-22. The Contractor is responsible for cutting cores or sawing plugs. One set of cores or plugs shall be obtained within the first 20 tons of material and every 100 tons thereafter for testing by the Contractor or the Department. The Engineer will randomly select plug or core locations. If the density is less than the 91.5 percent, payment will be made on the tonnage within the 20 or 100 ton lot in accordance with Table III-6.

**TABLE III-6**  
**Payment Schedule for Surface, Intermediate and Base Courses (Asphalt Patching)**

% TMD	% of Payment
Greater than or equal to 91.5	100
90.0-91.4	95
88. 1-89.9	90
Less than or equal to 88.0	Removal <sup>1</sup>

1. Removal shall be at no cost to the Department.

- (f) **Joints:** Transverse joints shall be formed by cutting back on the previous run to expose the full depth of the course. A coat of asphalt shall be applied to contact surfaces of transverse joints just before additional mixture is placed against the previously rolled material.

Joints adjacent to curbs, gutters, or adjoining pavement shall be formed by hand placing sufficient mixture to fill any space left uncovered by the paver. The joint shall then be set up with rakes or lutes to a height sufficient to receive full compression under the rollers.

- (g) **Rumble Strips:** This work shall consist of constructing rumble strips or rumble stripes on mainline shoulders or centerlines of highways by cutting concave depressions into existing asphalt concrete surfaces as shown on the Standards Drawings and as directed by the Engineer. Rumble stripes are defined as edgeline or centerline rumble strips with permanent longitudinal pavement markings subsequently installed within the rumble strip grooves.

Rumble strips and rumble stripes shall be installed in accordance with the RS-Series Standard Drawings. The Contractor shall demonstrate to the Engineer the ability to achieve the desired surface regarding alignment, consistency, and conformity with these Specifications and the Standard Drawings before beginning production work on mainline shoulders or centerlines. The test site shall be approximately 25 feet longitudinally at a location mutually agreed upon by the Contractor and Engineer.

**ORDER NO.: 247**  
**CONTRACT ID. NO.: CM224PMF123441B**

Pavement markings for rumble stripes shall be applied after the grooves have been cut. The grooves shall be thoroughly cleaned and the surface prepared before pavement marking application, in accordance with the Standard Drawings and Section 704. Overspray of pavement marking materials shall not extend more than one inch beyond the lateral position of the pavement marking line shown in the RS-Series Standard Drawings.

Rumble strips shall not be installed on shoulders of bridge decks, in acceleration or deceleration lanes, on surface drainage structures, or in other areas identified by the Engineer.

Waste material resulting from the operation shall be removed from the paved surface and shall be disposed of in accordance with Section 106.04.

- (h) **Saw-Cut Asphalt Pavement:** This work shall consist of saw-cutting the existing asphalt pavement to a depth as shown on the plans or as directed by the Engineer.
- (i) *Coating designed surface cuts:* Designed Surface Cuts are roadway features installed by cutting or grinding into a road surface, for example, Rumble strips, rumble stripes, and plastic inlaid marker grooves.

Designed Surface Cuts shall be coated with liquid asphalt coating (emulsion) when the Designed Surface Cuts are being cut into an existing asphalt surface (i.e. more than one year since placement); when new Designed Surface Cuts are being cut into the pavement surface in conjunction with a surface treatment, latex emulsion, or slurry seal pavement operation; or when the proposed plant mix surface is less than one inch deep.

Liquid asphalt coating (emulsion) shall not be used when Designed Surface Cuts are being cut into new pavement, or being cut in conjunction with plant mix paving operations where the proposed plant mix surface is one inch or greater in depth.

When liquid asphalt coating (emulsion) is required, the Contractor shall coat the entire rumble strip area with the liquid asphalt coating (emulsion) using a pressure distributor following the cutting and cleaning of the depressions of waste material. For rumble strips installed on the shoulder, the approximate application rate shall be 0.1 gallons per square yard. For centerline rumble stripes and plastic inlaid marker grooves, the approximate application rate shall be 0.05 gallons per square yard. The application temperature shall be between 160 degrees F and 180 degrees F. For shoulder rumble strips and plastic inlaid marker grooves, overspray shall not extend more than 2 inches beyond the width of the cut depressions and shall not come in contact with pavement markings.

If liquid asphalt coating (emulsion) is applied before installation of the plastic inlaid marker, then the bottom of the plunge cut shall be protected during liquid asphalt coating (emulsion) application so as to avoid inhibiting the ability of the marker epoxy to bond to the bottom of the plunge cut. If the liquid asphalt coating (emulsion) is applied after the plastic inlaid marker has been installed, then the retroreflector shall be protected during the liquid asphalt coating (emulsion) application to prevent the coating material from dirtying or damaging the retroreflector, with the protection removed after the coating has been completed.

### **315.06 – Pavement Samples**

The Contractor shall cut samples from the compacted pavement for depth and density testing. Samples shall be taken for the full depth of the course at the locations selected by the Engineer. The removed pavement shall be replaced with new mixture and refinished. No additional compensation will be allowed for furnishing test samples and reconstructing areas from which they were taken.

### **315.07—Pavement Tolerances**

**ORDER NO.: 247**  
**CONTRACT ID. NO.: CM224PMF123441B**

- (a) **Surface Tolerance:** The Engineer will test the pavement surface by using a 10-foot straight-edge. The variation of the surface from the testing edge of the straightedge between any two contacts with the surface shall not be more than 1/4 inch. The Contractor shall correct humps and depressions exceeding the specified tolerance or the defective work shall be removed and replaced with new material.
- (b) **Finished Grade Tolerance:** Finished grade elevations shall be within +/-0.04 foot of the elevations indicated in the plans after placement of the final pavement layer unless otherwise specified, provided the actual cross slope does not vary more than 0.20 percent from the design cross slope indicated in the plans, and the plan depth thickness conforms to the thickness tolerances specified herein.

If the Engineer determines either the finished grade elevations or cross slope exceed the specified tolerances, the Contractor shall submit a corrective action plan to the Engineer for approval.

- (c) **Thickness Tolerance:** The thickness of the base course will be determined by the measurement of cores as described in VTM-32.

Acceptance of asphalt concrete base course for depth will be based on the mean result of measurements of samples taken from each lot of material placed. A lot of material is defined as the quantity being tested for acceptance except that the maximum lot size will be 1 mile of 24-foot-width base course.

A lot will be considered acceptable for depth if the mean result of the tests is within the following tolerance of the plan depth for the number of tests taken:

Plan Depth	1 test	2 tests	3 tests	4 tests
≤4"	0.6"	0.5"	0.4"	0.3"
>4" ≤8"	0.9"	0.7"	0.5"	0.4"
>8" ≤12"	1"	0.9"	0.7"	0.5"
>12"	1.2"	1"	0.8"	0.6"

If an individual depth test exceeds the one test tolerance for the specified plan depth, the Engineer will exclude that portion of the lot represented by the test from the lot. If an individual test result indicates that the depth of material represented by the test is more than the tolerance for one test, the Contractor will not be paid for that material in excess of the tolerance throughout the length and width represented by the test. If an individual test result indicates that the depth of the material represented by the test is deficient by more than the one test tolerance for the plan depth, the Contractor shall correct the base course represented by the test as specified hereinafter.

If the mean depth, based on two or more tests, of a lot of material is excessive (more than the plan depth specified in the contract), the Engineer will not pay the Contractor for any material in excess of the tolerance throughout the length and width of the lots represented by the tests.

If the mean depth, based on two or more tests, of a lot of material is deficient (less than the plan depth specified in the contract) by more than the allowable tolerance, the Contractor will be paid for the quantity of material that has been placed in the lot. Any required corrective action will be determined by the Engineer.

For excessive depth base courses, the rate of deduction from the tonnage allowed for payment as base course will be calculated at a weight of 115 pounds per square yard per inch of depth in excess of the tolerance. For sections of base course that are deficient in depth by more than the one test tolerance and less than two and half times the one test tolerance, the Contractor shall furnish and place material specified for the subsequent course to bring the base course depth within the tolerance. This material will be measured on the basis of tonnage actually placed, determined from weigh tickets, and will be paid for at the contract unit price for the base course material. Such material shall be placed in a

**ORDER NO.: 247**  
**CONTRACT ID. NO.: CM224PMF123441B**

separate course. If the deficiency is more than two and half times the one test tolerance, the Contractor shall furnish and place base course material to bring the base course thickness within the tolerance. Corrections for deficient base course depth shall be made in a manner to provide a finished pavement that is smooth and uniform. Sections requiring significant grade adjustments which have been previously identified and documented by the Engineer as being outside of the control of the Contractor will be exempt from deduction or corrective action.

When the Contract provides for the construction or reconstruction of the entire pavement structure, the surface and intermediate courses shall be placed at the rate of application shown on the plans within an allowable tolerance of  $\pm 5$  percent of the specified application rate for application rates of 100 pounds per square yard or greater and within 5 pounds per square yard for application rates of less than 100 pounds per square yard. The Engineer will deduct the amount of material exceeding the allowable tolerance from the quantities eligible for payment.

When the Contract provides for the placement of surface or intermediate courses over existing pavement, over pavements constructed between combination curb and gutter, or in the construction or reconstruction of shoulders, such courses shall be placed at the approximate rate of application as shown on the plans. However, the specified rate of application shall be altered where necessary to produce the required riding quality.

### **315.08 – Measurement and Payment**

**Asphalt concrete base** will be measured in tons and will be paid for at the contract unit price per ton. This price shall include preparing and shaping the subgrade or subbase, constructing and finishing shoulders and ditches, and removing and replacing unstable subgrade or subbase.

**Asphalt concrete** will be measured in tons and will be paid for at the contract unit price per ton. Net weight information shall be furnished with each load of material delivered in accordance with Section 211. Batch weights will not be permitted as a method of measurement unless the Contractor's plant is equipped in accordance with Section 211, in which case the cumulative weight of the batches will be used for payment.

**Asphalt used in the mixtures**, when a pay item, will be measured in tons in accordance with Section 109.01 except that transporting vehicles shall be tare weighed prior to each load. The weight will be adjusted in accordance with the percentage of asphalt indicated by laboratory extractions.

**Tack coat**, when a pay item, will be measured and paid for in accordance with Section 310 of the Specifications. When not a pay item, it shall be included in the price for other appropriate pay items.

**Asphalt curb backup material** will be measured in tons and will be paid for at the contract unit price per ton. This price shall include placing, tamping, and compacting.

**Liquid Asphalt Cement**, when a pay item, will be measured in tons in accordance with Section 109.01 except that transporting vehicles shall be tare weighed before each load. When used in the mixture, the weight will be adjusted in accordance with the percentage of asphalt indicated by laboratory extractions.

**Warm Mix Asphalt (WMA)** additive or process will not be measured for separate payment, the cost of which, shall be included in the contract unit prices of other appropriate items.

**Rumble strips** will be measured in linear feet and will be paid for at the contract unit price per linear foot of mainline pavement or shoulder where the rumble strips are actually placed and accepted, excluding the test site. This distance will be measured longitudinally along the center line of pavement (mainline) or edge of pavement (shoulders) with deductions for bridge decks, acceleration/deceleration lanes, surface drainage structures, and other sections where the rumble strips were not installed. This price shall include installing, cleaning up debris and disposing of waste material. The test site will not be measured for payment but shall be included in the unit price for rumble strip.

**ORDER NO.: 247**  
**CONTRACT ID. NO.: CM224PMF123441B**

**Liquid asphalt coating** will be measured in square yards and will be paid for at the Contract square yard price. This price shall include cleaning Designed Surface Cuts before application of the coating, furnishing and applying coating, and protection of all retroreflectors.

**Saw-cut asphalt concrete pavement** will be measured in linear feet for the depth specified and will be paid for at the contract unit price per linear foot, which price shall be full compensation for saw-cutting the asphalt pavement to the depth specified, cleaning up debris and disposal of waste material.

These prices for asphalt shall also include heat stabilization additive(s), furnishing samples, and maintaining traffic.

Patching will be paid for at the contract unit price for the various items used unless a reconditioning item is included in the Contract.

Payment will be made under:

<b>Pay Item</b>	<b>Pay Unit</b>
Asphalt concrete base course (Type)	Ton
Asphalt concrete (Type)	Ton
Asphalt concrete curb backup material	Ton
Liquid asphalt cement	Ton
Liquid asphalt coating	Square yard
Rumble Strip Standard)	Linear foot
Saw-cut asphalt concrete (depth)	Linear foot

**ORDER NO.: 247**  
**CONTRACT ID. NO.: CM224PMF123441B**

SS321-002020-02

May 4, 2023

VIRGINIA DEPARTMENT OF TRANSPORTATION  
2020 ROAD AND BRIDGE SUPPLEMENTAL SPECIFICATIONS  
**SECTION 321 – TRENCH WIDENING**

**SECTION 321 – TRENCH WIDENING** of the Specifications is amended as follows:

**321.01 – Description**

This work shall consist of installing asphalt concrete mixtures into a constructed trench to widen shoulders and travel lanes up to but not including the surface mix in accordance with the Plans and Specifications and as directed by the Engineer.

**321.02 – Material**

(f) **Materials** shall conform to Section 211.02 and 315.02.

(g) **Trench widening material** IM-19.0A shall be used for IM-19.0A(T) and IM-19.0D shall be used for IM-19.0D(T). Where BM-25.0(T) is designated, either BM-25.0A or BM-25.0D shall be used by the Contractor.

**321.03 – Placement Limitations**

The Contractor shall not place asphalt concrete mixtures when weather or surface conditions are such that the material cannot be properly handled, finished, or compacted. The surface upon which asphalt concrete mixtures is to be placed shall be free of standing water, dirt, and mud and the base temperature shall conform to Section 315.04.

**321.04 – Procedure**

(a) **Trench Widening Route Types:** The minimum lift density as determined according to VTM-22 is based on the type of trench widening as defined below and specified in the Contract. Where trench widening is 2 feet in width, compaction may be performed with small single drum walk-behind rollers or other mechanical means acceptable to the Engineer.

1. **Type 1: Paved Shoulder Only** shall be installed on routes where the widening will serve as a paved shoulder and will not be subjected to constant traffic. The painted edge line will not be on the trench widening. The minimum density requirement will not be enforced and plugs/cores are not required for this type of trench widening. Steel double drum rollers weighing at least 8 tons shall perform compaction of the asphalt concrete. At least five passes shall be completed.
2. **Type 2: Widened Travel Lane and Paved Shoulder** shall be installed on routes where the widening will serve as a wider travel lane and paved shoulder that will be subjected to traffic. The widening will not include removal of existing travel lane pavement, i.e., inside the edge line marking. The painted edge line will be on the trench widening. The minimum density applies to this type of trench widening.
3. **Type 3: Repaired Travel Lane and Paved Shoulder** shall be used on routes where the widening will include a portion of the existing travel lane, serve as a paved shoulder and will be subjected to traffic as a part of the travel lane. The widening will include removal of existing pavement, i.e., inside the edge line marking. The painted edge line will be on the trench widening. The minimum density applies to this type of trench widening.

(b) Trench widening routes shall be widened by trenching on one or both sides of the existing roadway and placing Trench Widening Material in accordance with the width and depth specified for that route.

The depth of the base course will be determined by the measurement of cores as described in VTM-32 and 315.07(c), unless otherwise approved by the Engineer. Any remaining material, after final grading, shall be classified as excess material, and will be disposed of according to Section 106.04 of the Specifications or as directed by the Engineer.

The trench shall be shaped to have vertical sides with the width, depth and type specified in the Contract (2-foot minimum to 6-foot maximum width); be free of excess material; and shall be tacked against the existing pavement side before Trench Widening Material is placed.

**ORDER NO.: 247**  
**CONTRACT ID. NO.: CM224PMF123441B**

The Contractor shall ensure that disruption to driveways, entrances, mailboxes, and intersections are minimized and that precautions are taken to ensure that roadway drainage does not pond on the roadway surface.

**321.05 - Acceptance**

Where density requirements apply, the Contractor is responsible for cutting cores or sawing plugs for density testing. One plug or core per course of material shall be obtained within the first 500 feet and every 2,500 feet thereafter of the trench widening route for testing by the Contractor or the Department. Core and plug locations shall be randomly selected within each section. If the density achieved is less than 91.5% of the maximum theoretical density for the Type 2 or 3 trench widening routes, payment adjustment will be made on the actual tonnage within the 500- or 2,500-foot lot according to Table III-6 in Section 315.

**321.06- Measurement and Payment**

**Asphalt Concrete Type BM-25.0(T), IM-19.0A(T) or IM-19.0D(T)** will be measured in tons and will be paid for at the Contract ton price. This price shall include furnishing and placing the Trench Widening Material, trenching, tack, grading and disposing of excess material.

Payment will be made under:

<b>Pay Item</b>	<b>Pay Unit</b>
Asphalt Concrete Type BM-25.0(T)	Ton
Asphalt Concrete Type IM-19.0A(T)	Ton
Asphalt Concrete Type IM-19.0D(T)	Ton



**ORDER NO.: 247**  
**CONTRACT ID. NO.: CM224PMF123441B**

SS512-002020-03

July 1, 2022

VIRGINIA DEPARTMENT OF TRANSPORTATION  
2020 ROAD AND BRIDGE SUPPLEMENTAL SPECIFICATIONS  
**SECTION 512 – MAINTAINING TRAFFIC**

**SECTION 512 – MAINTAINING TRAFFIC** of the Specifications is amended as follows:

**Section 512.02(f) – Temporary (Construction) signs** is replaced with the following:

**Temporary (Construction) signs** shall have retroreflective sign sheeting in accordance with Sections 247 and 701.

Sign substrates for rigid temporary signs and temporary overlay panels shall be fabricated of either aluminum at least 0.080-inches thick, conforming to Section 229.02(a); 0.4-inch-thick corrugated polypropylene; 0.4-inch-thick corrugated polyethylene plastic; or 0.079-inch-thick aluminum/plastic laminate as approved by the Engineer. Sign substrates shall be smooth, flat, and free of metal burrs or splinters.

Sign substrate materials for signs mounted on drums, Type 3 barricades, and portable sign stands shall be as specified below and shall be the same material that was used when the device was approved in accordance with National Cooperative Highway Research Program (NCHRP) Report 350 or MASH.

**Sign Substrates for Type 3 Barricades and Portable Sign Stands**

---

Rollup sign  
0.4 inch thick corrugated polypropylene or polyethylene plastic  
0.079 inch thick aluminum/plastic laminate

---

**Sign Substrates for Drums**

---

0.4 inch thick corrugated polypropylene or polyethylene plastic

---

**Section 512.03 – Procedures** is amended by replacing the sixth and seventh paragraphs with the following:

The Contractor shall correct ineffective or unacceptable work zone traffic control devices immediately unless allowed otherwise by the Contract.

The color of Automated Flagger Assistance Device trailers, arrow board trailers, portable traffic control signal trailers, ITS trailer equipment, and portable changeable message sign trailers and sign frames shall be either Virginia highway orange (DuPont Color No. LF74279 AT or color equivalent) or federal yellow. The back traffic facing trailer frame, where the signal and brake lights are located, shall be fully covered with 2 inch high retroreflective sheeting conforming to Section 247.02(c). The sheeting shall have alternating 11 inch wide vertical red stripes and 7 inch wide vertical white stripes.

The Contractor shall locate, remove, and dispose of all existing asphalt-embedded Snowplowable Raised Pavement Marker (SRPM) castings which lie within a travel lane that has been shifted during construction for three months or longer. The cavity left by the removal of the existing marker shall be cleaned of debris, filled with an approved mix design for resurfacing or material found on the Department's Approved List 78, and compacted before shifting traffic.

**Section 512.03(a) – Temporary Signs** is replaced with the following:

**ORDER NO.: 247**  
**CONTRACT ID. NO.: CM224PMF123441B**

**Temporary Signs:** The Contractor shall furnish, install, remove, relocate, and maintain temporary signs and sign panels necessary for prosecution of the work which shall include but not be limited to, maintenance of traffic, off project detour signs, and begin and end of road work signs for construction, maintenance, permit, utility, and incident management activities. Installation shall be in accordance with Section 701. The Contractor shall also furnish and install those signs not listed in the *VWAPM*, the *MUTCD*, or the Contract (such as "Turn Lane Open with arrow" and "Grooved Pavement Ahead") that may be required by the Engineer.

Signs shall be fabricated in accordance with the *MUTCD*, *VWAPM*, the FHWA Standard Highway Signs and Markings book (including its Supplement), and the Virginia Standard Highway Signs book. If the Contractor proposes a sign message not included in the Plans, *VWAPM*, or *MUTCD*, then the Contractor shall submit a sign fabrication detail to the Engineer for approval before fabrication. The sign fabrication detail shall include sign size, legend, font, legend dimensions, radius, border, margins, sheeting type, and colors.

The Contractor shall relocate, cover, uncover, remove, and reinstall existing signs that conflict with the signs needed for maintenance of traffic. Covering of existing signs shall be accomplished in accordance with Section 701.03(d).

The Contractor shall ensure an unrestricted view of sign messages. The Contractor shall furnish and install flags for temporary signs, as directed by the Engineer; however flags will not be required for use on portable sign supports.

Sign location, lateral placement, and mounting height shall conform to the *VWAPM*, the *MUTCD*, the Contract, and as directed by the Engineer. The Contractor shall furnish all sign supports and hardware for use with temporary signs.

When the sign sequence is not provided in the plans, either by illustration or reference to a typical traffic control figure in the *VWAPM*, the Contractor shall submit a sketch of his proposed sign sequencing and positioning to the Engineer for approval before installation.

Temporary signs shall be mounted using wooden post supports, square tube sign post supports, or portable sign stands, except where noted otherwise on the Plans. Portable sign stands shall not be used longer than three consecutive days (72 continuous hours). Wooden and square tube post installations shall be in accordance with Standard Drawing WSP-1.

Portable sign stands manufactured on or before December 31, 2019 may be used if they are in good working condition, conform to NCHRP Report 350 Test Level 3 or MASH, and are a product shown on the Traffic Control Device Pre-Approval list. Portable sign stands manufactured after December 31, 2019 shall conform to MASH and shall be a product shown on the Department's Approved List for MASH Approved Products. The Contractor shall submit a certification letter stating the brands and models of portable sign stands to be used along with a copy of the certification letters indicating compliance with NCHRP Report 350 Test Level 3 or MASH. Portable sign stands shall support a 20 square foot sign in sustained winds of 50 mph or wind gusts of passing vehicles without tipping over, walking, or rotating more than  $\pm 5$  degrees about its vertical axis.

Portable sign stands shall include decals, stenciling, or some other durable marking system that indicates the manufacturer and model number of the stands. Such marking shall be of sufficient size so it is clearly legible to a person in a standing position.

The Contractor shall erect, maintain, move, and be responsible for the security of sign panels and shall ensure an unrestricted view of sign messages for the safety of traffic.

**ORDER NO.: 247**  
**CONTRACT ID. NO.: CM224PMF123441B**

**Section 512.03(g)2b(1) – Drums** is replaced with the following:

**Drums** shall be round or partially round; made from plastic; have a minimum height of 36 inches; have a cross-sectional width no less than 18 inches in any direction; have a closed top; and shall conform to the VWAPM. Drums shall be designed to allow for separation of ballast and drum upon vehicular impact but not from wind and vacuum created by passing vehicles. The base of the unit height shall not exceed 5 inches. Two-piece drums may have a flared drum foundation, a collar not exceeding 5 inches in height and be of suitable shape and weight to provide stable support. One-piece drums that comply with these requirements may be used.

The Contractor shall furnish and install signs (Stop, Chevron, keep Right, etc.) for drums when directed by Engineer. Signs used on drums shall be tested for conformance with NCHRP 350, Test Level 3, and/or MASH requirements and shall be made of the same material used in the test. The Contractor may use other materials allowed by the FHWA acceptance letter when approved by the Engineer.

**Section 512.03(g)2b(3) – Direction indicator barricades** is deleted.

**Section 512.03(h) –Traffic Barrier Service** is replaced with the following:

**Traffic Barrier Service** shall be of sufficient length to provide anchorage and protection of traffic and personnel in work areas.

The Contractor shall begin continuous progressive prosecution of the work protected by the barrier once the barrier is in place until its completion. If the Contractor ceases to continuously prosecute such work, the Engineer may cause the Contractor to discontinue operations in other areas on the project and concentrate work efforts behind the traffic barrier service until that work is completed. The Contractor shall remove the traffic barrier service when the Engineer determines work is completed to the extent that traffic barrier service is no longer required.

While performing work activities, workers and equipment shall remain behind the protection of the traffic barrier service except as approved by the Engineer. Work outside traffic barrier service protection shall only proceed under the protection and direction of approved traffic control devices or flagger service to safeguard workers and traffic in advance of and at the point the traffic barrier service is opened for ingress or egress adjacent to the travel lane. The Engineer will not permit any equipment extending into an open travel lane.

Barrier openings for access to the work area may be provided only along tangent sections or along curved sections on the inside of traffic and shall be limited to the minimum length required for equipment access. The Contractor shall delineate and maintain normal pavement alignment at the barrier opening with Type D pavement marking.

At ingress openings, the exposed end of the barrier service shall be provided with a temporary impact attenuator approved by the Engineer. At egress openings, the exposed end shall be transitioned at a rate that complies with the VWAPM. For speeds below 30 mph, the transition flare rate shall be the same as that indicated for 30 mph. An impact attenuator will not be required at the exposed end of egress openings in barrier service provided the deflection angle between the pavement edge and the ends of the barrier service openings is 20 degrees or more.

Repairs to traffic barrier service shall match existing barrier so that positive connections can be maintained.

**ORDER NO.: 247**  
**CONTRACT ID. NO.: CM224PMF123441B**

Delineators and barrier panels shall have reflectorized sheeting conforming to Section 247, shall be from the Department's Approved List 23, and shall be installed on traffic barrier service in accordance with the VWAPM.

The Contractor shall maintain the structural integrity of the barrier and its alignment while it is in use and shall maintain any associated warning lights, barrier delineators, barrier panels, and other devices in functional, clean and visible conditions at all times.

1. **Guardrail barrier service and terminal treatments** shall be installed in accordance with Section 505 except that the offset distance shall be as specified by the Engineer. The Contractor may be permitted to reuse guardrail or its hardware used for traffic barrier service guardrail for permanent installation provided the guardrail material is acceptable to the Engineer and conforms to Section 505 and the Standard Drawings for such guardrail. Marred galvanized surfaces shall be repaired in accordance with Section 233. Terminal treatments shall be permanently identified with a device specific Manufacturers' identification number by stamping or marking with a durable weather resistant material in accordance with § 33.2-274.1 of the Code of Virginia.
2. **Traffic barrier service** (concrete or longitudinal steel) shall be installed in accordance with the Plans and Standard Drawings or as directed by the Engineer, who will design according to Appendix A of the VWAPM. When traffic barrier ends at guardrail, fixed object attachment methods for construction zone shall be used to connect the barrier to the guardrail. Installation shall include additional guardrail posts and attachments as required. The traffic barrier, at a minimum, shall be tapered with the end of the barrier located behind the adjacent guardrail post in accordance with the VWAPM. Barrier connections shall be snug to prevent motion between sections.

Traffic barrier service used as a parapet shall be anchored as shown on the Plans or Section 500 of the Standard Drawings. Anchor holes in bridge decks shall be drilled with a rotary impact drill or other approved equipment that will limit damage to the deck. Anchor holes shall be located to avoid cutting reinforcing steel. Upon removal of the parapet, anchor holes shall be cleaned and filled with Type EP-4 or EP-5 epoxy mortar conforming to Section 243.

The Department will not permit the use of concrete traffic barrier service for permanent installations on bridge structures.

Traffic barrier service sections manufactured on or before December 31, 2019 and successfully tested to NCHRP 350 or MASH 2009 may be used until December 31, 2029, if they are in good working condition, and are a product shown on the Department's Approved Lists for NCHRP-350 or MASH Approved Products. Traffic barrier service sections manufactured after December 31, 2019, and all products in use after December 31, 2029, shall conform to MASH 2016 or its successor, and shall be from the Department's Approved List for Provisionally Approved MASH Products. All traffic barrier service runs shall be interlocking barrier of the same design or type.

The Contractor shall visually inspect all traffic barrier service shipped to a project before placing it in use. Concrete barrier sections shall be structurally sound with no concrete missing along the top, bottom, sides, or end sections of the barrier; no through cracks; and no exposed rebar. The Contractor shall promptly remove any traffic barrier service found by the Contractor or Engineer to be unacceptable due to inadequate structural integrity or functionality and replace the concrete barrier service at no cost to the Department.

Concrete barrier service shall be cleaned or coated sufficiently to afford good visibility and uniformity of appearance.

**ORDER NO.: 247**  
**CONTRACT ID. NO.: CM224PMF123441B**

The Engineer will review and must approve the layout and anchorage method for job specific applications before the barrier is authorized for installation.

With the approval of the Engineer, the Contractor may use additional traffic barriers for his convenience but at his own expense.

**Section 512.03(i) – Impact Attenuator Service** is replaced with the following:

**Impact Attenuator Service:** The Contractor shall install impact attenuator service at locations shown on the Plans or designated by the Engineer. An object marker for temporary impact attenuator shall be installed on the attenuator according to the details shown in the Standard Drawings. The object marker for impact attenuator service shall have reflective sheeting conforming to Section 247 featuring alternating diagonal black and orange 3 inch stripes sloping downward at an angle of 45 degrees in the direction vehicular traffic is to pass. Impact attenuators shall be permanently identified with a device specific Manufacturers' identification number by stamping or marking with a durable weather resistant material in accordance with § 33.2-274.1 of the Code of Virginia.

Impact Attenuator Service not shown on the Plans may be used at the request of the Contractor for the Contractor's convenience at the Contractor's expense.

All impact attenuator service shall be reviewed and approved by the State Location and Design Engineer before installation.

Impact Attenuators manufactured on or before December 31, 2019 and successfully tested to NCHRP 350 or the MASH 2009 may continue to be used until December 31, 2029. Impact Attenuators manufactured after December 31, 2019 shall meet MASH 2016 and shall be from the Department's Approved List for Provisionally Approved MASH Products.

**Section 512.03(j)2c – Equipment** is replaced with the following:

12 inch aluminum or polycarbonate traffic signal head sections with backplates mounted in the vertical display arrangement. Signal head sections may be mounted in the horizontal display arrangement when approved by the Engineer. Signal head sections and backplates shall conform to Section 238.

**Section 512.03(k) – Temporary (Construction) Pavement Markings** is replaced with the following:

**Temporary (Construction) Pavement Markings** shall be installed at locations shown on the Plans, the *VWAPM*, and as directed by the Engineer. Temporary pavement markings shall conform to Section 704 and be selected from the Department's Approved List 17. Temporary pavement markings are classified as Type A or B (temporary markings), Type D, Class III (removable tape), Type E (non-reflective black removable tape), and Flexible Temporary Pavement Markers (FTPMS).

The Contractor shall install temporary pavement markings in accordance with the manufacturer's recommendations, except that if the manufacturer's recommendation for material thickness and quantity of beads is less than that used when the material was tested by the NTPEP, the minimum product application rates shall conform to the NTPEP approved test rates for the specific marking. The Contractor shall furnish a copy of the manufacturer's installation recommendations, including the NTPEP data for product thickness and glass bead quantities to the Engineer.

**ORDER NO.: 247**  
**CONTRACT ID. NO.: CM224PMF123441B**

The Contractor shall maintain the temporary pavement markings and shall correct any deficient markings by reapplying markings as directed or needed. The Department considers deficient any temporary pavement markings that provide inadequate guidance to motorists due to inadequate retroreflectivity, color qualities, or adherence to the pavement. The Engineer will make a visual nighttime inspection of all temporary pavement markings to identify areas where markings have inadequate retroreflectivity. Other deficient qualities may be identified by visual inspection at any time.

Markings that no longer adhere to the pavement, and may cause guidance problems for motorists, or are inadequately retroreflective as determined by the Engineer shall be replaced by the Contractor, with the following exceptions:

- Reapplication of skip line temporary pavement markings is not required unless the pavement marking does not adhere or inadequate retroreflectivity qualities are present for at least two consecutive skip lines.
- Reapplication of centerline (except skip lines) or edge line temporary pavement markings is not required unless the pavement marking does not adhere or inadequate retroreflectivity qualities are present for a continuous section of at least 70 feet.
- Reapplication of transverse markings is not required unless the pavement marking does not adhere or inadequate retroreflectivity qualities are present for a continuous section of at least 3 feet.

The Contractor may take retroreflectivity readings to counter visual observations by the Engineer as the basis for replacement of temporary pavement markings. These measurements shall be taken within 48 hours after the Contractor has been notified of the visual determination by the Engineer of deficient markings. The Engineer will grant additional time to the Contractor when inclement weather prevents accurate measurement of the temporary pavement markings.

The Contractor shall brush any form of debris from the marking before taking the retroreflectivity readings. Retroreflectivity measurements shall be taken in the presence of the Engineer using Contractor furnished equipment conforming to ASTM E1710. A copy of the operating instructions for the reflectometer shall be furnished to the Engineer before taking the measurements. The Contractor shall calibrate and operate the equipment in accordance with the manufacturer's instructions. The photometric quantity to be measured is the coefficient of retroreflected luminance (RL), which shall be expressed as millicandelas per square foot per footcandle (mcd/sf/ftc). Measurements shall be taken at three random locations within each area of markings that are suspected of being inadequately retroreflective. When the length of the questionable visually inspected area is greater than 1 mile, the Contractor shall take measurements at three locations per mile segment or portion thereof. Measurements for all lines shall be taken in the middle of the line horizontally. Measurements for skip lines shall be taken in the middle of their length. Measurements for transverse lines shall be taken outside of the wheel path locations. The Engineer will designate the locations along the line segments where the measurements shall be taken. The Contractor shall make a log of the measurements and their locations and provide a copy to the Engineer. When the average of the three readings for an area is below 100 mcd/sf/ftc, the Contractor shall reapply the markings as indicated.

Temporary (construction) pavement markings found in need of reapplication in accordance with these requirements shall be reapplied by the Contractor at no additional cost to the Department, with the following exceptions:

- Type D markings that have been under traffic for more than 180 days and requires reapplication will be paid for at the contract unit price when reapplied, unless the manufacturer's warranty coverage is still applicable.
- Markings damaged by the Department's snow removal or other maintenance and construction operations will be paid for at the contract unit price.

**ORDER NO.: 247**  
**CONTRACT ID. NO.: CM224PMF123441B**

Deficient temporary pavement markings shall be replaced in the time specified in Section 704 for the maximum duration of unmarked roads.

Eradication for reapplication of Type A or B pavement markings is not required if allowed by the marking manufacturer, if the existing marking is well adhered and the total thickness of the existing and reapplied marking combined will not exceed 40 mils. If not well adhered, 90 percent of the existing markings shall be eradicated before reinstallation of the markings.

Existing Type D markings that are deficient (no longer retaining sufficient retroreflectivity) shall be removed before reapplication of new Type D, Class III markings.

1. **Temporary Type A or B pavement markings** shall be used where the roadway is to be resurfaced before changes in the traffic pattern or where pavement is to be demolished and traffic patterns will not change before demolition.
2. **Type D, Class III pavement markings** shall be used on final roadway surfaces or in areas where traffic patterns are subject to change before pavement is resurfaced, unless otherwise specified in the Contract.

On non-final pavement surfaces, the Contractor may install Type A or B pavement markings when the surface temperature of the pavement is below the manufacturer's minimum application temperature for a Type D pavement marking. In such cases, the Contractor shall select a Type A or B product known to perform the best under those temperature conditions. When a Type A or B pavement marking is used instead of a Type D pavement marking due to the surface temperature being below the manufacturer's minimum application temperature, the Contractor will be paid at the contract unit price for Type D pavement marking. This shall include the Type A or B marking and any necessary eradication of the Type A or B pavement marking.

3. **Type D, Class III contrast pavement markings** shall be used for all longitudinal temporary pavement markings on bridge decks and hydraulic cement concrete riding surfaces if all of the following are met:
  - The road has a speed limit of 45 MPH or greater.
  - The hydraulic cement concrete riding surface in question is at least 200 feet in length.
  - The temporary markings are planned for at least 30 days of use.

Type D, Class III contrast markings are not required for any markings that are parallel to and within one foot of existing guardrail or other longitudinal barrier.

4. **Type E pavement markings** shall be used to cover existing markings in accordance with paragraph (l) herein.
5. **Flexible Temporary Pavement Markers (FTPMS)** may be used to simulate a temporary pavement marking line on the final surface, as an interim measure until the permanent pavement marking can be installed. FTPMs shall not be used in substitution for lines slated to be in place for more than 30 days.

FTPMS shall conform to Section 235 and shall consist of products from the Department's Approved List 22. All FTPM's shall be new product. FTPMs are suitable for use up to one year after the date of manufacture when stored in accordance with the manufacturer's recommendations.

**ORDER NO.: 247**  
**CONTRACT ID. NO.: CM224PMF123441B**

FTPMS shall include a removable material covering the reflective lens to protect the lens from being obscured or damaged during the paving operation.

FTPMS spacing shall be as follows:

- When simulating solid lines, the FTPMS shall be placed every 20 feet.
- When simulating double lines, pairs of side-by-side FTPMS shall be placed every 20 feet.
- When simulating broken lines with a 10-foot-skip/30-foot-gap pattern, 3 FTPMS shall be used per skip (5 feet between each FTPMS), with a 30-foot gap between simulated skips.
- When simulating dotted lines with a 3-foot skip/9-foot-gap pattern, 2 FTPMS shall be used per skip (3 feet between the two FTPMS), with a 9-foot gap between simulated skips.

FTPMS shall not be used to simulate transverse lines, symbol/message markings, or dotted lines with 2-foot dot/6-foot-gap pattern.

The color of FTPMS units and their reflective surfaces shall be the same color (white or yellow) as the temporary pavement markings they are being used in substitution for.

FTPMS shall be installed at the same locations that permanent pavement markings will be installed.

For surface treatment, slurry seal or latex emulsion treatment operations, the appropriate FTPMS with protective covering shall be installed before placing the new treatment. The lens protective covering shall be kept in place during the final surface placement to protect the lens from being obscured or damaged by the paving operation. Upon completion of surface treatment, slurry seal or latex emulsion treatment placement, the Contractor shall remove the protective covering from the reflective lens of the FTPMS before leaving the work site. Failure to remove such covering shall result in the non-payment for that portion type (skip or solid) of temporary pavement marking.

For plant mix operations, the appropriate FTPMS shall be installed on the newly-placed pavement after the pavement is thoroughly compacted and has cooled to the FTPMS manufacturer's recommended temperature for installation.

The Contractor shall maintain the FTPMS until the permanent pavement markings are installed. Damaged or missing FTPMS shall be replaced within 24 hours of discovery at the Contractor's expense with new FTPMS of the same manufacturing type, color and model. No more than one FTPMS may be damaged or missing out of every skip line or dotted line simulated segment. No two consecutive FTPMS may be damaged or missing on a simulated solid line or double line application, and no more than 30% of the FTPMS may be damaged or missing on any measured 100-foot segment of simulated solid line.

Once applied, FTPMS will be considered for a single use. If a FTPMS requires replacement before installation of permanent pavement markings, it shall be properly disposed of and replaced with a new FTPMS at no additional cost to the Department.

FTPMS shall be removed and properly disposed of when permanent pavement markings are installed. Used FTPMS removed from the pavement, including all containers, packaging, damaged FTPMS's and all other miscellaneous items of waste, shall be appropriately disposed of in accordance with Section 106.04.

**Section 512.03(I) – Eradicating Pavement Markings** is replaced with the following:



**ORDER NO.: 247**  
**CONTRACT ID. NO.: CM224PMF123441B**

**Eradicating Pavement Markings:** Markings that may conflict with desired traffic movement, as determined by the Engineer, shall be eradicated as soon as practicable: either immediately before the shifting of traffic or immediately thereafter and before the conclusion of the workday during which the traffic shift is made. Work shall be done in accordance with Section 704 except as noted herein.

The Contractor shall perform eradication by grinding, blasting, or a combination thereof. Blasting may be performed using water blasting, sand blasting, hydroblasting (combination of sand and water), or shot blasting. Water blasting and hydroblasting shall be done with equipment that includes a vacuum recovery system and capability to adjust the water pressure.

The Contractor may submit other methods for eradication for the Engineer's approval; however, the Department will not permit obscuring existing pavement markings with black paint or asphalt as a substitute for removal or obliteration. The Contractor shall minimize roadway surface damage when performing the eradication. The Contractor shall repair the pavement if eradication of pavement markings results in damage to or deterioration of the roadway presenting unsafe conditions for motorcyclists, bicyclists, or other road users. Pavement repair, when required, shall be performed using a method approved by the Engineer.

The Contractor shall ensure workers are protected in accordance with Section 107.17 when eradicating pavement markings.

The Contractor shall vacuum or collect the eradication residue (removed markings, debris, and water) during and immediately after the eradication operation. Dust shall be collected during the entire operation. The Contractor shall ensure that no debris enters inlets or waterways.

Eradication residue from the removal of any pavement markings is considered to be a nonhazardous waste material and shall be disposed of in a properly permitted waste disposal facility in accordance with applicable state and federal laws and regulations. The Department does not require Contractor testing of the eradication residue for the eight Resource Conservation Recovery Act metals.

When markings are removed for lane shifts, transitions, or other areas or conditions required in the VWAPM, 100% of the pavement marking shall be removed.

Type E pavement markings may be used to cover existing markings instead of eradication on asphalt concrete surfaces. The Contractor shall use this material to cover markings as indicated in the Plans or as directed by the Engineer. Type E pavement marking shall be applied in accordance with the manufacturer's recommendations. Type E markings shall not be adhered to the pavement for more than 120 days. Type E markings shall not be used on HCC surfaces or bridge decks.

When eradicating symbols and messages, the entire theoretical box bounding the outermost limits of the markings shall be uniformly eradicated.

Eradication of 24" lines shall be considered nonlinear marking eradication.

**Section 512.03(m) – Temporary Pavement Markers** is renamed **Temporary Raised Pavement Markers** replaced with the following:

**Temporary Raised Pavement Markers** shall be installed with temporary pavement markings where required by the VWAPM and where directed by the Engineer. Temporary raised pavement markers shall not be used with Type E markings.

**ORDER NO.: 247**  
**CONTRACT ID. NO.: CM224PMF123441B**

Temporary raised pavement markers shall be installed at the spacing required by the VWAPM, and as shown on Standard Drawing PM-8. . The Contractor may install two one-way markers instead of each two-way marker at no additional cost to the Department.

Temporary raised pavement markers shall be installed with a hot applied bitumen adhesive, except epoxy may be used on hydraulic cement concrete roadways and non-final surfaces of asphalt concrete roadways. Pavement damage caused by removing markers shall be repaired in kind by the Contractor at no additional cost to the Department.

The Contractor shall replace damaged, ineffective, or missing temporary raised pavement markers upon notification by the Engineer at no additional cost to the Department. Markers damaged by the Department's snow removal operations or other maintenance and construction operations, however, will be paid for at the contract unit price.

**Section 512.03(p) – Temporary Pavement Message and Symbol Markings** is replaced with the following:

**Temporary Pavement Message and Symbol Markings** shall be the color, shape, and size required by the MUTCD, Standard Drawing PM-10, and the Plans. The Contractor shall install message and symbol markings in accordance with MUTCD, Section 704, the VWAPM, and the Standard Drawings.

Temporary pavement message and symbol markings shall be installed and maintained using the material specified on the Plans in accordance with Section 512.03(k).

Pavement message/symbol markings shall be installed at locations shown on the Plans and at locations designated by the Engineer.

Temporary pavement message markings shall be maintained in accordance with Section 512.03(k). Retroreflective measurements conforming to Section 512.03(k) shall be taken out of the wheel path locations. The pavement message/symbol marking shall be replaced when the average of the three readings for the symbol/message is below 100 mcd/sf/ft.

**Section 512.03(q) – Type 3 Barricades** is replaced as follows:

**Type 3 Barricades:** Type 3 barricades shall conform to NCHRP Report 350, Test Level 3, or MASH. Type 3 barricades shall be selected from those shown on the Department's Traffic Control Device Pre-Approval List. The Contractor shall provide a certification letter stating the brands and models of Type 3 barricades from the list proposed for the project. Instead of using Type 3 barricades on the listing, the Contractor may use other brands and models, if he submits a copy of the FHWA acceptance letter indicating the proposed substitutes complies with Test Level 3 of NCHRP Report 350 or MASH before use.

Type 3 Barricades shall be installed and ballasted in accordance with the VWAPM.

**Section 512.03(r) – Truck-mounted or trailer mounted attenuators** is replaced as follows:

**Truck-mounted or trailer-mounted attenuators (TMAs):** Truck-mounted and trailer-mounted attenuators manufactured on or prior to December 31, 2019 may be used if they are in good working condition, conform to Test Level 3 of NCHRP Report 350 or MASH, and are a product shown on the Department's Approved Lists for NCHRP-350 or MASH Approved Products. TMAs manufactured after December 31, 2019 shall conform to MASH Test Level 3 and shall be a product shown on the Department's Approved List for MASH Approved Products.

**ORDER NO.: 247**  
**CONTRACT ID. NO.: CM224PMF123441B**

The Contractor shall submit catalog cuts/brochures of the TMA and a copy of the certification letter documenting NCHRP 350/MASH compliance of the specific TMA before their use on the project. TMAs shall be permanently identified with a device-specific manufacturers' identification number by stamping or marking with a durable weather resistant material in accordance with § 33.2-274.1 of the Code of Virginia.

The weight of the support vehicle shall be as recommended by the manufacturer of the Truck/Trailer-mounted attenuator. The Contractor shall provide a copy of the manufacturer's recommendations to the Engineer, a copy of the original weigh ticket for the support vehicle, and a self-certification letter stating the support vehicle has not been altered since the original weight ticket was issued. The weigh ticket shall contain adequate information to identify the ticket with the applicable support vehicle. A copy of the self-certification and weigh ticket shall be available in the support vehicle at all times and upon request.

Additional weight may be added to the support vehicle to achieve the range recommended by the manufacturer of the Truck/Trailer-mounted attenuator provided the total weight is properly balanced without overloading any one axle, and is within the Gross Vehicle Weight Recommendation of the support vehicle. The added weight shall be securely attached to the support vehicle to prevent movement during an impact or movement of the vehicle. The additional weight and attachment method shall be self-certified by the Contractor and a copy of the self-certification letter shall be with the support vehicle at all times or a final stage manufacturer's certification sticker may be placed on the inside door of the altered vehicle.

The Truck/Trailer-mounted attenuator shall be no less than 72 inches wide and no more than 96 inches wide. There shall be no additional devices such as signs, lights, and flag holders attached to the Truck/Trailer-mounted attenuator except those that were tested on the Truck/Trailer-mounted attenuator and provided by the manufacturer of the Truck/Trailer-mounted attenuator.

The support vehicle shall have at least one vehicle warning light functioning while in operation in accordance with the VWAPM. When allowed by the VWAPM, an electronic arrow operated in the caution mode may be used with the vehicle warning light. When installing and removing lane closures on a multilane roadway as well as when performing mobile operations, the support vehicle shall be equipped with both vehicle warning lights and an arrow board.

The support vehicle shall be operated and parked in accordance with the manufacturer's recommendations.

**Limitations:** Traffic control devices shall not be installed from or removed to the Truck/Trailer-mounted attenuator support vehicle. When the Truck/Trailer-mounted attenuator is deployed there shall be no unsecured material in the bed of the support vehicle except the additional secured weight or truck-mounted devices such as an arrow board, a changeable message sign, or truck mounted signs. There shall also be no additional devices such as signs, lights, and flag holders attached to the Truck/Trailer-mounted attenuator except those that were tested on the Truck/Trailer-mounted attenuator and provided by the manufacturer of the Truck/Trailer-mounted attenuator.

If the Truck/Trailer-mounted attenuator is impacted, resulting in damage that causes the unit to be ineffective, all work requiring the use of the Truck/Trailer-mounted attenuator shall cease until such time that repairs can be made or the Contractor provides another acceptable unit.

**ORDER NO.: 247**  
**CONTRACT ID. NO.: CM224PMF123441B**

**Section 512.03(s) – Portable Changeable Message Signs** is amended to replace the second and third paragraphs with the following:

The sign shall be capable of sequentially displaying at least 2 phases of 3 lines of text each with appropriate controls for selection of messages and variable off-on times. Trailer-mounted PCMS shall be capable of displaying 3 lines of 8-character 18-inch text in a single phase, and vehicle-mounted PCMS shall be capable of displaying 3 lines of 8-character 10-inch text in a single phase. Each character module shall at a minimum use a five wide by seven high pixel matrix. The message shall be composed from keyboard entries.

Access to PCMS control mechanisms shall be physically locked at all times when deployed to deter message tampering.

The message shall be legible in any lighting condition. Motorists should be able to read the entire PCMS message twice while traveling at the posted speed.

The sign panel support shall provide for an acceptable roadway viewing height that shall be at least 7 feet from bottom of sign to crown of road.

**Section 512.03(w) – Portable Temporary Rumble Strips (PTRS)** is replaced as follows:

**Portable Temporary Rumble Strip (PTRS):**

A PTRS may be made of rubber or recycled rubber. It shall have a recessed, raised or grooved design to prevent movement and hydroplaning. PTRS color shall be in accordance with the VWAPM.

A PTRS shall consist of interlocking or hinged segments of equal length that prevent separation when in use. The combined overall usable length of the PTRS shall be between 10 feet 9 inches and 11 feet. The width of the PTRS shall be 12 to 13 inches. PTRS shall be between 5/8 inch and 1.0 inch in height. The weight of each roadway strip shall be between 100 and 120 pounds. The leading and departing edge taper shall be between 12 and 15 degrees.

Each roadway length of the PTRS shall have either a minimum of one cutout handle in the end of the rumble strip, or an interlocking segment which can be used as a handle for easy deployment or removal.

The manufacturer of the PTRS shall provide a signed affidavit that states the PTRS is able to withstand being run over by an 80,000 pound vehicle and retain its original placement with minor incidental movement of 6 inches or less during an 8 hour deployment. Incidental movement of the PTRS shall be parallel with other rumble strips in an array but shall not move so that its placement compromises the performance and safety of the other rumble strips, workers or the traveling public.

The PTRS shall be installed in accordance with manufacturers installation instructions, without the use of adhesives or fasteners.

PTRS Placement shall be in accordance with the VWAPM.

**Section 512.04 – Measurement and Payment** is amended to replace the 13th paragraph with the following:

**Impact attenuator service** will be measured in units of each and will be paid for at the Contract each price for the type specified. This price shall include installing, maintaining, and removing

**ORDER NO.: 247**  
**CONTRACT ID. NO.: CM224PMF123441B**

impact attenuator and object marker. Impact attenuators used with barrier openings for equipment access will not be measured for separate payment but the cost thereof shall be included with other appropriate items. When impact attenuator service is moved to a new location, as directed or approved by the Engineer, the relocated terminal will be measured for separate payment. Payment for impact attenuator service will not be made until the work behind the corresponding barrier service is actively pursued.

**Section 512.04 – Measurement and Payment** is amended to replace the 16th paragraph with the following:

**Temporary pavement markings** will be measured in linear feet and will be paid for at the contract linear foot price for the type, class and width specified. This price shall include marking materials, glass beads, adhesive, preparing the surface, maintaining, removing removable markings when no longer required, inspections, and testing.

If the Contractor uses FTPMs to simulate the temporary pavement marking, they will be measured in linear feet and paid for at the linear foot price for the temporary marking material being simulated. That measurement shall represent all FTPMs required for that simulated line marking. No additional payment will be made if the Contractor elects to remove FTPMs and install other temporary pavement markings. This cost shall include furnishing, installing and maintaining the FTPMs, removable covers, surface preparation, quality control tests, daily log, guarding devices, removal, and disposal.

**Section 512.04 – Measurement and Payment** is amended to replace the 21st paragraph with the following:

**Eradication of existing nonlinear pavement markings** will be measured in square feet based on a theoretical box defined by the outermost limits of the nonlinear pavement markings as defined in Standard Drawing PM-10. Nonlinear pavement markings shall include but not be limited to, arrows, images, symbols, and messages. Eradication of existing nonlinear pavement markings will be paid for at the contract unit price per square foot. This price shall include removing nonlinear pavement markings, cleanup, and disposing of residue.

**Section 512.04 – Measurement and Payment** is amended to replace the 30th paragraph with the following:

**Portable Temporary Rumble Strip (PTRS) Array** will be measured in Days per array and will be paid for at the Contract Day price. An Array shall consist of three rumble strips. This price shall include installing, maintaining, removing devices when no longer required, and relocating throughout the day.

**Section 512.04 – Measurement and Payment** is amended by revising the Pay Item Table as follows:

The following pay items are removed:

<b>Pay Item</b>	<b>Pay Unit</b>
Portable temporary rumble strip	Each

The following pay items are inserted:

**ORDER NO.: 247**  
**CONTRACT ID. NO.: CM224PMF123441B**

Pay Item	Pay Unit
Portable temporary rumble strip array	Day

**ORDER NO.: 247**  
**CONTRACT ID. NO.: CM224PMF123441B**

SS704-002020-02

May 6, 2022

VIRGINIA DEPARTMENT OF TRANSPORTATION  
2020 ROAD AND BRIDGE SUPPLEMENTAL SPECIFICATIONS  
**SECTION 704 – PAVEMENT MARKINGS AND MARKERS**

**SECTION 704 – PAVEMENT MARKINGS AND MARKERS** of the Specifications is amended as follows:

**Section 704.02 – Materials** is amended to replace the first paragraph with the following:

For Type B, Class VI pavement marking materials that are to be applied to latex emulsion or slurry seal surfaces, the selected Type B, Class VI manufacturer shall be a manufacturer that approves and warrants their product for application on that type of surface.

**Section 704.03 – Procedures** is amended to replace the second paragraph with the following:

The Contractor shall have a certified Pavement Marking Technician present during all temporary pavement marking, permanent pavement marking, and pavement marker operations, except Flexible Temporary Pavement Marker (FTPM) installation.

**Section 704.03 – Procedures** is amended to replace the fourth through tenth paragraph with the following:

If the Contractor cannot have permanent pavement markings installed within the time limits specified, the Contractor shall install and maintain temporary pavement markings within the same time limits at no additional cost to the Department until the permanent pavement markings can be installed. Installation, maintenance, and removal or eradication of temporary pavement markings shall be according to Section 512.

The Contractor may mark the locations of proposed permanent markings on the roadway by installing premarking materials. Premarkings may be accomplished by installing removable tape, chalk, or lumber crayons, except pavement markings such as stop lines, crosswalks, messages, hatching, etc., shall be premarked using chalk or lumber crayons. Premarkings for yellow markings may be white or yellow. Premarkings for other colors shall be white.

When tape is used as a premarking material, premarking shall consist of 4- inch by 4-inch-maximum squares or 4-inch-maximum diameter circles spaced at 100-foot minimum intervals in tangent sections and 50-foot minimum intervals in curved sections. At locations where the pavement marking will switch colors (e.g., gore marking) the ends of the markings may be premarked regardless of the spacing.

When the Contractor uses chalk or lumber crayon as a premarking, the entire length of the proposed pavement marking may be premarked.

Premarkings shall be installed so their installation will not affect the adhesion of the permanent pavement markings. When removable tape is used as the premarking material and the lateral location of such premarkings to location of the final pavement markings exceeds 6 inches, the tape shall be removed at no additional cost to the Department.

The Contractor shall exercise caution and protect the public from damage while performing pavement marking operations. The Contractor shall be responsible for the complete preparation of the pavement surface, including, but not limited to, removing dust, dirt, loose particles, oily residues, curing compounds, concrete laitance, residues from eradication, and other foreign matter immediately before installing pavement markings. The pavement surface shall be clean and dry at the time of pavement marking installation and shall be tested in accordance with VTM 94 before permanent installation, with the VTM 94 test results noted on Form C-85. The

**ORDER NO.: 247**  
**CONTRACT ID. NO.: CM224PMF123441B**

Contractor shall provide the equipment indicated in VTM 94 that are needed to perform the moisture test before application.

**Section 704.03 – Procedures** is amended by replacing the thirteenth paragraph with the following:

Non-truck mounted equipment shall be regulated to allow for calibration of the amount and type of material applied.

**Section 704.03 – Procedures** is amended to replace the eighteenth paragraph with the following:

Glass beads and retroreflective optics shall be applied at the rate specified herein or as specified in the Department's Approved List for the specific pavement marking product. Beads and optics shall be evenly distributed over the entire lateral and longitudinal surface of the marking. The Contractor shall apply beads to the surface of liquid markings with a bead dispenser attached to the applicator that shall uniformly dispense beads simultaneously on and into the just-applied marking. The bead dispenser shall be equipped with a cut-off control synchronized with the applied marking material cut off control so that the beads are applied totally on the marking. Beads shall be applied while the liquid marking is still fluid, resulting in approximately 60% embedment in the marking's surface. Beads installed on crosswalks and stop lines on roadways with curbs only (no gutter) may be hand applied for two feet at the end of each line next to the curb with 100 percent of the beads embedded 50% to 60% into the marking's surface.

**Section 704.03(a)1 – Type A markings** is replaced with the following:

**Type A markings** shall be applied in accordance with the manufacturer's installation instructions. When applying atop existing pavement markings, the existing marking shall first be swept or eradicated to the extent necessary to ensure that the surface of the existing marking is clean, chalk free (not powdery), and well adhered.

Glass beads for Type A, Class I markings shall be AASHTO M 247 Type 1 Beads applied at a minimum rate of 6 pounds per gallon of paint

Retroreflective optics for Type A, Class II markings shall be applied as noted in the Department's Approved List 20 for the selected pavement marking product.

The Contractor may substitute Type A, Class I cold weather paint (traffic paint designed for application at temperatures below 40 °F) for Type A, Class I conventional paint at no additional cost to the Department. Cold weather paint shall be from the Department's Approved List 20.

**Section 704.03(a)2 – Type B markings** is amended to replace the third paragraph with the following:

Non-truck mounted equipment for application of thermoplastic material shall include an extrude die with a burner, temperature controller, agitator, and mechanical bead applicator to allow for the correct amount of material to be applied.

**Section 704.03(a)2a – Thermoplastic (Class I)** is amended to replace the fourth through sixth paragraphs with the following:

Thermoplastic shall not be applied over existing pavement markings of materials other than paint or thermoplastic, unless the existing marking is 90 percent percent worn away or eradicated. When applying thermoplastic over existing paint or thermoplastic, the existing marking shall first be swept or eradicated to the extent necessary to ensure that the surface of the existing marking is clean, chalk free (not powdery), and well adhered.



**ORDER NO.: 247**  
**CONTRACT ID. NO.: CM224PMF123441B**

Thermoplastic marking material shall be applied at thickness of 90 mils ( $\pm$  5 mils) above the riding surface, whether dense or open graded surface.

Glass beads and retroreflective optics shall be surface applied at the rate of 10 pounds per 100 square feet unless specified otherwise on the Materials Division's Approved Products List 43 for the specific thermoplastic product.

**Section 704.03(a)2b – Preformed thermoplastic (Class II)** is amended to replace the first and second paragraphs with the following:

**Preformed thermoplastic (Class II)** material shall be installed in accordance with the manufacturer's installation instructions. A primer or sealer manufactured by or recommended by the preformed thermoplastic manufacturer shall be applied to all hydraulic cement concrete surfaces and to asphalt concrete surfaces in accordance with the manufacturer's installation instructions.

Preformed thermoplastic shall not be applied over existing pavement markings of materials other than paint or thermoplastic, unless the existing marking is 90 percent worn away or eradicated. When applying preformed thermoplastic over existing paint or thermoplastic, the existing marking shall first be swept or eradicated to the extent necessary to ensure the surface of the existing marking is clean, chalk free (not powdery), and well adhered.

Permanent transverse rumble strips shall be applied using two strips of white Type B, Class II material. The bottom strip shall be 250 mils thick and 4 inches wide, and the top strip shall be 125 mils thick and 2 inches wide (centered atop the bottom strip), unless noted otherwise in the plans. Transverse rumble strips shall be installed in arrays as per the Standard Drawings and the plans.

**Section 704.03(b) – Pavement messages and symbols markings** is amended to replace the second paragraph with the following:

Surface temperature at time of application shall be in accordance with manufacturer's installation instructions. If the installation instructions do not specify minimum surface temperature, then the markings shall not be installed unless the surface temperature at time of application is 50°F or higher. Surface temperature requirements shall not be considered met if the temperature is forecasted to drop below the minimum within two hours of application. The Contractor may heat the pavement for a short duration to dry the pavement surface and bring the surface temperature to within the allowable temperatures for pavement marking installation, at no extra cost to the Department. Heat torch temperatures shall not exceed 300°F. The Contractor shall monitor pavement temperature to ensure it does not rise above 120°F at any time. Any damage to the pavement shall be promptly repaired at no extra cost to the Department.

Message and symbol markings include, but shall not be limited to, those detailed in Standard Drawing PM-10.

The sizes and shapes of symbols and characters shall match the size and shape specified in Standard Drawing PM-10 or elsewhere in the Contract. Hand-drawn or "stick" symbols or characters will not be allowed.

**Table VII-3** is replaced with the following:

**TABLE VII-3**  
**Pavement Markings**

---

**ORDER NO.: 247**  
**CONTRACT ID. NO.: CM224PMF123441B**

Type	Class	Name	Film Thickness (mils)	Pavement Surface	Application Limitations	Appr. List No.
A	I	Conventional or Cold-Weather Traffic Paint	15 ± 1 when wet	AC HCC	May be applied directly after paving operations	20
A	II	High Build Traffic Paint	25 ± 2 when wet	AC HCC	May be applied directly after paving operations	20
B	I	Thermoplastic Alkyd	90 ± 5	AC HCC	May be applied directly after paving operations	43
	I	Thermoplastic Hydrocarbon	90 ± 5 when dry	AC HCC	Do not apply less than 30 days after paving operations	43
	II	Preformed Thermoplastic	120-130	AC HCC	Manufacturers installation instructions	73
	III	Epoxy resin	20 ± 1 when wet	AC HCC	Manufacturers installation instructions	75
	IV	Plastic-backed preformed Tape	60 - 120	AC HCC	Manufacturer's installation instructions	17
	VI	Patterned preformed Tape	20 min <sup>1</sup> 65 min <sup>2</sup>	AC HCC	(Note 4)	17
	VII	Polyurea	20 ± 1	AC HCC	Manufacturer's installation instructions	74
D	III	Wet Reflective Removable tape	(Note 3)	AC HCC	Temporary pavement marking	17
E		Removable black tape (Non-Reflective)	(Note 3)	AC	Temporary pavement marking for covering existing markings	17

<sup>1</sup>Thinnest portion of the tape's cross section.

<sup>2</sup>Thickest portion of the tape's cross section.

<sup>3</sup>In accordance with manufacturer's installation instructions.

<sup>4</sup>In accordance with the manufacturer's installation instructions, except that Type B, Class VI markings on new plant mix asphalt surfaces shall be inlaid into the freshly installed asphalt surface and not surface-applied.

**Section 704.03(d)1 – Snowplowable raised pavement markers** is renamed **Section 704.03(d)1 – Inlaid Pavement Markers** and replaced as follows:

VI. **Inlaid Pavement Markers** shall be installed with retroreflectors with front-side and back-side colors as per Standard Drawing PM-8.

VII. The Contractor shall not install markers on existing bridge decks. Inlaid Pavement Markers shall be installed on new bridge decks where required by the Plans.

VIII. Inlaid Pavement Markers shall be placed in relation to pavement joints and cracks as follows:

- In existing Asphalt Concrete pavement, new or existing Hydraulic Cement Concrete pavement, and bridge decks, the edge of the groove shall be at least 2 inches from pavement joints and cracks, ensuring that the finished line of markers is straight in accordance with the tolerance for pavement markings specified in Section 704.03 of the Specifications. Offset from the longitudinal joint shall take precedence over straightness of the line of markers.
- In new Hydraulic Cement Concrete pavement or when installed in conjunction with new latex modified microsurfacing or slurry seal treatments, the edge of the groove shall be at

**ORDER NO.: 247**  
**CONTRACT ID. NO.: CM224PMF123441B**

least 2 inches from all longitudinal and transverse surface course pavement joints and 1 inch maximum off alignment from the corresponding pavement marking line. The finished line of markers shall be straight in accordance with the tolerance for pavement markings specified in Section 704.03 of the Specifications. Straightness of the line of markers and alignment with the corresponding pavement marking line takes precedence over offset from the surface course joint.

Retroreflectors shall be affixed to holders, using an adhesive from the Department's Approved List 22 (Inlaid Pavement Markers) prior to installation.

Inlaid Pavement Markers shall be installed as per Standard Drawing PM-8.

Tapered grooves and plunge cuts shall be cut using diamond blades that can accurately control the groove dimensions, resulting in smooth uniform tapers and smooth groove bottoms and ensuring the pavement does not tear or ravel. The Contractor shall remove all dirt, grease, oil, loose or unsound layers, and any other material from the groove which would reduce the bond of the adhesive. Pavement surfaces shall be maintained in a clean and dry condition until the marker is placed.

Holders shall be installed in the same shift as grooving.

The epoxy adhesive shall be thoroughly mixed until it is uniform in color, and applied in accordance with the manufacturer's installation instructions. The Contractor shall partially fill the plunge cut with sufficient epoxy adhesive such that the epoxy adhesive bed area is equal to the bottom area of the holder. The Contractor shall then set the holder in the epoxy adhesive such that the breakaway tabs are resting on the road surface, the holder is centered in the cut, and then fill in additional epoxy adhesive if necessary so the entire perimeter of the holder is completely surrounded in epoxy, with the epoxy level with the edge of the holder in accordance with the manufacturer instructions.

The Contractor shall remove all adhesive and foreign matter from the face of the retroreflector or replace the retroreflector if adhesive and foreign matter cannot be removed. The marker shall be replaced if it is not properly positioned and adhered in the plunge cut.

**Section 704.03(d)2 – Raised Pavement Markers** is renamed **Nonplowable Raised Pavement Markers** and is replaced with the following:

IX. **Nonplowable raised pavement markers** shall be bonded to the surface in accordance with the manufacturer's installation instructions. The bonding material shall be from the Department's Approved List 22 for the specific marker.

**Section 704.04 – Measurement and Payment** is amended to replace the fifth paragraph with the following:

X. **Pavement markers** will be measured in units of each for the type specified and will be paid for at the contract unit price per each. This price shall include surface preparation, furnishing, installing, prismatic retroreflectors, pavement cutting, adhesive, holders, quality control tests, and daily log.

**ORDER NO.: 247**  
**CONTRACT ID. NO.: CM224PMF123441B**

**Section 704.04—Measurement and Payment** is amended by revising the Pay Item Table as follows:

The following pay items are removed:

<b>Pay Item</b>	<b>Pay Unit</b>
Pavement message marking (Message)	Each or Linear Foot

The following pay items are inserted:

<b>Pay Item</b>	<b>Pay Unit</b>
Pavement message marking (Message, Type or class material)	Each or Linear Foot

**TIER 1 PROJECT  
 “NO PLAN” RAAP (CONSTRUCTION & MAINTENANCE) PROJECTS  
 COMMONWEALTH OF VIRGINIA  
 DEPARTMENT OF TRANSPORTATION**

**CONSTRUCTION:** \_\_\_\_\_ **MAINTENANCE:**  X

DISTRICT:  Salem  CITY/COUNTY:  Henry & Patrick  UPC NO.:  123441

FUNCTIONAL CLASS  Other Principal Arterial  FHWA 534 DATA  23105  TYPE CODE  F000

ROUTE:  Various  PROJ.  PM2F-962-F24,P401  FEDERAL NO.:  PM02492

FROM:  Various  TO:  Various

LENGTH (FEET):  111,989  MILES  21.21

TOPO:  N/A  DESIGN SPEED (MPH):  N/A  VPD (YEAR)  2,000 – 19,999 (Varies)

PROJECT MGR:  Ibrahim Abuawad, P.E.  R/W DONATION:  N/A

Utilities  N/A  and/or Railroads  N/A  are involved in the construction of this project.

This project is to be constructed in accordance with the Department's 2020 Road and Bridge Specifications, 2016 Road and Bridge Standards, 2009 MUTCD, 2011 Virginia Supplement to the MUTCD, 2011 Work Area Protection Manual and as amended by contract provisions and the complete plan assembly.

Design features relating to construction or to regulation and control of traffic may be subject to change as deemed necessary by the department.

<b>RECOMMENDED FOR APPROVAL FOR CONSTRUCTION</b>	
8/25/2023	Anthony Ford, P.E.
DATE	DISTRICT PLANNING AND INVESTMENT MANAGER
8/30/2023	Thomas W. DiGiulian, P.E.
DATE	DISTRICT PROJECT DEVELOPMENT ENGINEER
<b>APPROVED FOR CONSTRUCTION</b>	
9/1/2023	Kenneth H. King, Jr, P.E.
DATE	DISTRICT ADMINISTRATOR

Commonwealth of Virginia  
Department of Transportation  
Salem District Primary Plant Mix General Notes

**Salem District Notes:**

Tonnage is included in all contract items for wedges, connections, crossovers, and turn lanes as shown.

Routes to be restricted during certain times are indicated within the contract line item.

Routes where work is to be performed only during certain dates are indicated within the contract line item. This restriction applies to all contract work within that line item.

The Department reserves the right to alter any of their time restrictions as deemed necessary by the Engineer.

All night work shall be completed by November 1<sup>st</sup>.

All Routes: No asphalt course shall be opened to traffic or have subsequent pavement overlays placed when the temperature of the pavement is above 150 degrees Fahrenheit.

All Counties: The contractor shall remove the raised snow plowable pavement markers prior to paving. The cost of removing raised snow plowable pavement markers shall be included in the bid price of other items. Where raised snow plowable pavement markers are removed, the contractor shall patch these areas at the time of removal. The cost of this patching shall be included in the bid price of other items. The contractor will be responsible for the disposal of the removed markers.

All Counties: Any gouged areas resulting in excessive depth from planing operations shall be scratched and repaired at the contractor's expense.

All Counties: All Primary Routes will be required to have non-polishing aggregate in all surface mixes, regardless of traffic count.

All Counties: When milling is required in areas containing manhole covers and other obstructions, the contractor will be required to remove pavement adjacent to same. Removal of pavement adjacent to same shall be included in the milling price.

Milling and pavement inlay shall be required for all overlay locations with overhead structures in order to prevent decreasing the clearance between the structure and the roadway.

On all line items for spot milling, the areas will be located as directed by the Engineer. In addition, the contractor will be responsible for the clean up of all milling debris to assure that no build-up of the millings is allowed to cause drainage problems along the edge of the pavement. Spot milling consists of milling multiple locations of variable widths and lengths as determined by the Engineer. Base Asphalt (BM-25.0) shall be subject to traffic for no more than 10 calendar days.

The quantities for shoulder stone shown on the contract are for estimating purposes only. If wetlands, rivers, streams, springs, wet ditches, lakes, ponds, or other jurisdictional waters are encountered; the contractor shall not disturb and shall not encroach upon these areas with shoulder stone, asphalt, or other fill material.

If the Contractor inadvertently dumps or discharges fill material in jurisdictional waters or performs any activity that disturbs these areas he shall take immediate actions to prevent further disturbance or discharges of fill material and shall immediately notify the Engineer.

All Counties: If the contractor chooses to use slag as an alternative to natural aggregate, adjustments shall be made to compensate for the difference in specific gravity of the slag compared to the natural aggregate. The pay total for the roadway section where slag is being used as an alternate material shall be based on the tonnage of a mix using 100% natural aggregate at the plant where the mix is being produced.

The following will be used to determine the Adjusted Pay Total:

- A = Line Item Tonnage
- B = % Asphalt (decimal form)
- C = Specific Gravity of Slag Mix
- D = Specific Gravity of Natural Aggregate Mix
- E = Design Lbs/Sq. Yd. (Natural Agg. Mix)
- F = Tons of Slag Produced

$$\text{Estimated Slag Mix Tonnage, } G = [A - (A \times B)] \times (C/D) + (A \times B)$$

$$\text{Slag Mix Lbs./Sq. Yd.} = E \times (G/A)$$

$$\text{Adjusted Pay Total} = F \times (A/G)$$

All overlay locations containing bridge structures, unless otherwise noted or directed by the Engineer, will require a smooth transition for entering and exiting the structure.

A Truck Mounted Attenuator (TMA) shall be used during installation of pavement markings, pavement markers or, loop detectors, as shown in the current **Virginia Work Area Protection Manual** or current **MUTCD** or as directed by the Engineer.

All traffic control devices and signs necessary for maintenance of traffic shall be furnished, installed, maintained, and removed by the Contractor.

All traffic control device locations shall be marked by the Contractor and reviewed by the Engineer prior to installation.

Flagging operations shall be in accordance with the current **Virginia Work Area Protection Manual**.

All signs installed shall be in accordance with the current **Virginia Work Area Protection Manual**, **Virginia Standard Highway Sign book**, the **Standard Highway Signs and Marking book** and the current **MUTCD** for Streets and Highways.

Construction and permanent pavement marking shall be installed in accordance with manufactures practices, Section 1300 of the Road and Bridge Standards, and VDOT Road and Bridge Specifications, latest edition.

Line marking shall be in accordance with Section 704 of the Road & Bridge Specification.

All existing pavement marking shall be replaced as the existing is currently marked unless otherwise indicated within the contract.

Prior to installing inlaid Pavement Markers, the pavement surface shall be dry and the minimum temperature shall be no less than stated in the Specifications.

The clear zone is to be free of stored materials and parked equipment. Sight distance at interchanges and entrances shall not be impacted by parked construction vehicles or equipment.

**Holidays:**

In addition to the aforementioned restrictions in the contract, the following will apply to all line items unless waived in writing by the Engineer. All traffic lanes shall be open to traffic per the specifications listed **Section 108.02—Limitation of Operations** of the Road and Bridge Specifications.

Note: The VDOT Engineer reserves the right to monitor traffic conditions impacted by the work, and the Engineer shall have the authority to impose additional restrictions for other holidays or special events as determined necessary in the event that safety or other conditions warrant, and to change and/or alter the work hour time frame(s) accordingly.

If the Contractor chooses to work near a school during the non-summer vacation months of the school, the Contractor shall contact the local school officials for times to perform all paving operations in the vicinity of school entrances or on routes adjacent to school entrances to minimize impacts to bus schedules.

No work is to be done on Routes near schools during the week prior to the beginning of school and the first week of school.

No lane closures are allowed on primary roads in Carroll County from the Thursday prior to, until the Tuesday after, Memorial Day and Labor Day, unless otherwise approved by the Engineer.



# TRANSPORTATION MANAGEMENT PLAN

Project PM2F-962-F24, P401  
UPC 123441

## TEMPORARY TRAFFIC CONTROL PLAN

### General Notes

**TMP Type:** Type A Category 1 Project

**Material & Equipment Storage:** Will be determined on site.

**Work Zone location(s):** This project will take place in Henry and Patrick County.

**Scope of Work:** This project will involve milling and placing surface asphalt on primary roadways in Henry and Patrick County. There will also be temporary and permanent pavement markings applied during and after paving operations, and inlaid pavement markers installed.

### **Temporary Traffic Control Reference:**

Maintenance of Traffic Operations shall be conducted in accordance with the 2011 Virginia Work Area Protection Manual (Rev. 2.1), the 2009 MUTCD, 2011 Virginia Supplement to the MUTCD and all subsequent revisions of these documents, the 2020 Road and Bridge Specifications and the July 2022 supplement to the 2020 Road and Bridge Specifications. The work zones shall be designed, installed, maintained, and removed in accordance with the 2011 Virginia Work Area Protection Manual (VWAPM). A comprehensive list of temporary traffic control applications for this project include but are not limited to this comprehensive list:

- Figure TTC-13.2, pages 6H-34 and 6H-35
- Figure TTC-14.2, pages 6H-36 and 6H-37
- Figure TTC-15.2, pages 6H-38 and 6H-39
- Figure TTC-16.2, pages 6H-40 and 6H-41
- Figure TTC-17.2, pages 6H-41 and 6H-42
- Figure TTC-23.2, pages 6H-54 and 6H-55
- Figure TTC-24.2, pages 6H-56 and 6H-57
- Figure TTC-26.2, pages 6H-60 and 6H-61
- Figure TTC-27.2, pages 6H-62 and 6H-63
- Figure TTC-28.2, pages 6H-64 and 6H-65
- Figure TTC-29.2, pages 6H-66 and 6H-67
- Figure TTC-30.2, pages 6H-68 and 6H-69
- Figure TTC-42.2, pages 6H-92 and 6H-93
- Figure TTC-46.2, pages 6H-100 and 6H-101
- Figure TTC-56.2, pages 6H-120 and 6H-121
- Figure TTC-58.1, pages 6H-124 and 6H-125
- Figure TTC-68.0, Pages 6H-144 and 6H-145

Although temporary traffic control applications are listed, they may not include every situation. If the temporary traffic control applications listed are not applicable, it is the contractor's responsibility to choose the most appropriate Temporary Traffic Control (TTC) designs from Chapter 6H in the VWAPM to protect all workers and motorists during each work activity being performed. The TTC

shall be installed in full compliance with the VWAPM, any changes or modifications to the TTC's shall be signed and sealed by a Professional Engineer licensed in Virginia at no additional cost to the Department and submitted in writing to the Engineer for approval prior to the work zone installation and in accordance with the contract Request for Information (RFI) requirements.

**Special Details:**

The control of traffic through signalized intersections in order of preference should be:

- A. Obtain the services of law enforcement personnel with the approved signing as shown on TTC-30.2.
- B. Divert the effective routes to other roads and streets as approved and directed by the District Traffic Engineer.
- C. Place a state certified flagger on each leg of the intersection with the approved signing as shown.

Portable temporary rumble strips shall be used on two-lane roadways in accordance Special Provision for EMPLOYMENT OF PORTABLE TEMPORARY RUMBLE STRIPS in this Contract and when conditions are met in Section 6F.99 paragraph 4 of the VWAPM.

Portable Temporary Rumble Strips (PTRS) shall be used when conditions are met in Section 6F.99 paragraph 4 of the VWAPM and:

- PTRS should be used in both travel lanes on the first day.
- PTRS do not have to be removed or adjusted to the flagger's new location(s) when one flagger is non-stationary and moving with the operation.
- PTRS are required at intersecting roadways when the flagger has been relocated 300 feet in advance of the intersecting roads STOP or YIELD sign.
- For multiple day operations at the same location, the PTRS should be used on the unimproved approach to that day's operation, but not on the completed surface treatment side of the roadway with loose gravel.

A PCMS shall be placed  $\frac{1}{2}$  to  $\frac{3}{4}$  of a mile South of state route 685/Joseph Martin Highway for the West 58 Business off-ramp detour on North Business 220 during the ramp closure/detour to alert drivers of the detour. The PCMS message is below:

W BUS 58/RAMP/CLOSED AND USE/ROUTE/685

Flagger signs shall be installed when law enforcement personnel control a signalized intersection.

On two-lane roadways where work is non-stationary, additional flagger symbol signs should be erected every  $\frac{1}{2}$  mile or taken down as the operation proceeds beyond that area. Motorists should have a clear line of sight from the flagger symbol to the flagger when possible.

Turn lanes on connecting intersections shall be controlled by flagging operations, lane closures, turn lane closures or temporary traffic control for maintain turning movement (such as TTC-26.2 and TTC-68.0) in accordance with the VWAPM.

On a multilane roadway or a five-lane roadway with a left-turn only center lane, when workers are within the clear zone of opposing traffic, the left lane shall be closed in the opposite direction using TTC-17.2 or TTC-42.2. See the VWAPM, Appendix Figure 2 (page A-4), for clear zone values.

On two-lane roadways the Contractor shall notify property owners one week in advance of beginning surface treatment.

On two-lane roadways the Contractor shall be responsible for notifying the all home and business owners within the activity area of the resurfacing operations scheduled in this contract by distributing door-hangers. A template for printing door-hangers will be provided to the Contractor by the Department. The Contractor shall make all necessary arrangements to furnish and distribute the printed door-hangers to homes no more than thirty (30) days prior to commencement of work and no less than three (3) days in the affected areas.

The cost of furnishing and distributing door-hangers shall be borne by the Contractor at no cost to the Department. Door Hangers shall be produced in color and laminated prior to distribution.

End of day signing shall be adjusted to the activity area and spaced in accordance with the VWAPM. All sign stands shall be supported with a sandbag weighing approximately 25-pounds on each leg or two (2) drum collar weights positioned on the center of the sign stand.

Temporary and/or permanent pavement markings shall be installed at the end of each workday or as directed by the Engineer.

End of Day signing shall comply with TTC-58.1.

**Allowable Work Hours:**

Refer to section 108.02 Limitations of Operations in the 2020 Road and Bridge Specifications.

Route 57EB Sections: No lane closure restrictions necessary.

Route 58WB and 58WB business sections in Henry County: No lane closure restrictions necessary.

Route 220NB (0.0-3.65): No lane closures on weekends with Martinsville NASCAR races.  
Otherwise, no lane closure restriction necessary.

Route 220NB (3.65-6.66): No lane closures will be allowed Monday-Friday 7:00am-9:00am and 3:30pm-7:00pm. No lane closures will be allowed Saturday-Sunday 7:00am-7:00pm. No lane closures on weekends with Martinsville NASCAR races.

Route 58WB in Patrick County: No lane closure restrictions necessary.

Ramps: Allowable Work Hours for ramp closures on all detoured ramps in this schedule will be from Sun-Fri 7PM-6AM unless otherwise directed by the engineer.

The Department reserves the right to alter any of their time restrictions as deemed necessary by the Engineer.

## TRANSPORTATION OPERATIONS PLAN

This plan is not required on this project. However, a contact list of local emergency response agencies must be kept and maintained throughout the project life cycle.

### LCAMS:

The Traffic Operations Center (540-375-0170) shall be notified at the beginning of work impacting travel lanes for all paving operations and shall also be notified upon removal of the work zone operation.

The Contractor shall be responsible for notifying VDOT of all planned lane closures. The Contractor shall input the request(s) into the Lane Closure Advisory Management System (LCAMS) in accordance with the Special Provision. Training is required in order to access the LCAMS system, please contact the SWRO Lane Closure Coordinator, Vicky Reed at (540) 798-8108 or [vicky.reed@vdot.virginia.gov](mailto:vicky.reed@vdot.virginia.gov) for assistance with lane closure coordination and LCAMS.

### Traffic Backup Notification:

Emergency contact for this project shall be **911**.

The Traffic Operations Center (**540-375-0170**) shall be notified of traffic backups related to the work by the project staff. The TOC will utilize available systems (cameras, sensors, etc.) to monitor the work area and all adjacent areas. The TOC will make entries into systems that feed this information into 511. The TOC will utilize assets such as variable message signs to alert motorists of lane closures and other incidents that may impact travel. PCMS boards shall be equipped with cellular connectivity capabilities.

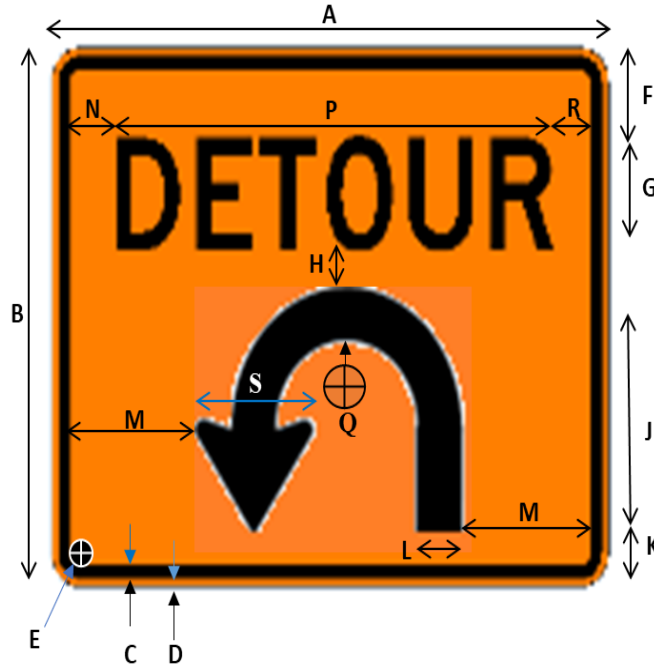
The TOC will also make notifications to department staff. The staff notifications shall include but not be limited to the Duty Officer, Area Construction Engineer, Project Maintenance of Traffic Coordinator, Project Manager, Resident Engineer, Districtwide Area Work Zone Safety Coordinator, District Safety Manager, Responsible District Traffic Engineer, District Traffic Operations Manager, Regional Incident Management Coordinator, and District Communications Office of any incidents and expected traffic delays.

The TOC shall be responsible for intra-agency notifications to entities such as but not limited to Virginia State Police, Local 911, and other affected agencies.

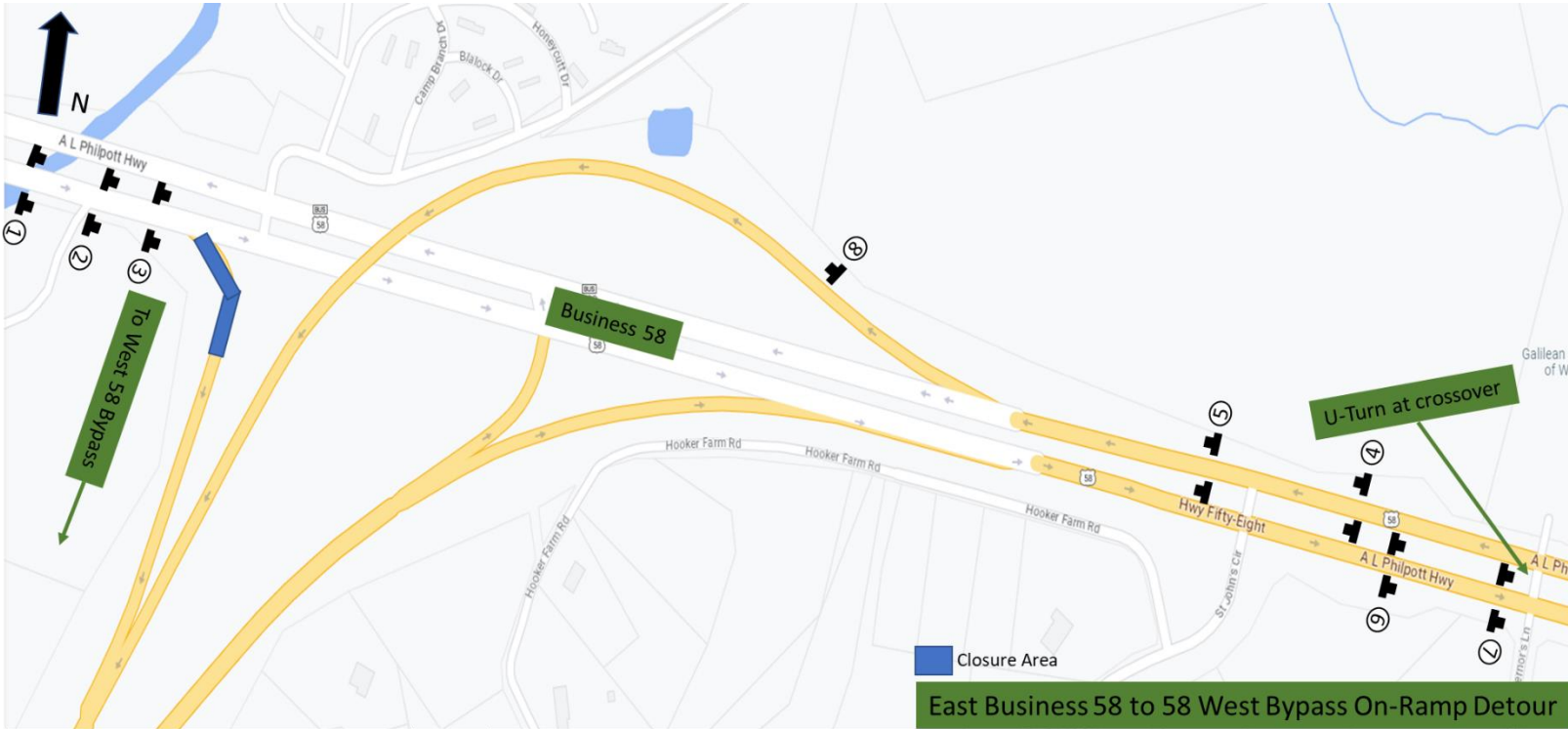
A review of all major incidents, as determined by the Regional Incident Management Coordinator, shall be accomplished within 48 hours of clearance of the incident. VDOT Project Staff, District Operations Staff, Traffic Engineering Work Zone Safety Coordinator, Salem Area Construction, Contractor Staff, and emergency responders shall be represented at these meetings.

### The following is a list of Local Emergency contact agencies:









911 Center	911
Haz-Mat Center (if spill involved)	911
Henry County Sheriff	276-656-4200
Patrick County Sheriff	276-694-3161
Virginia State Police (Henry and Patrick)	276-635-3060 (Area 42)

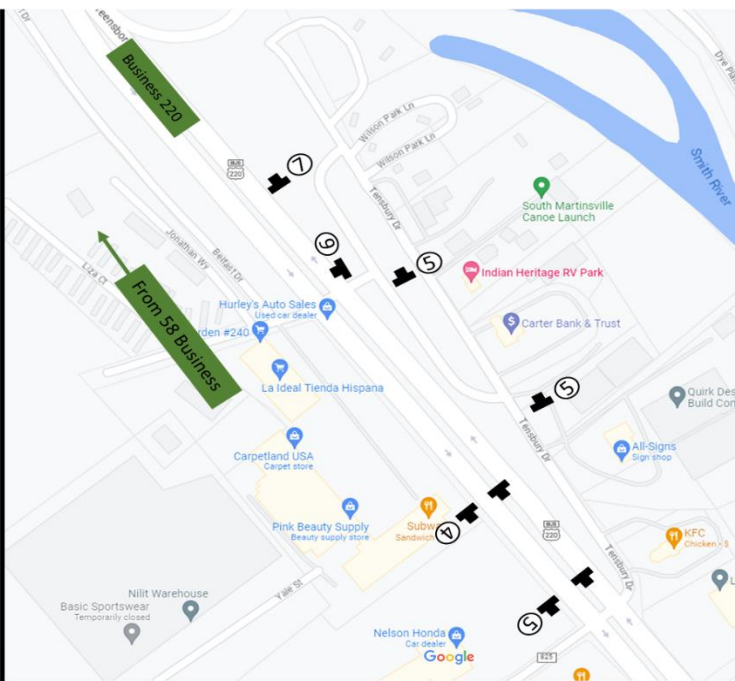
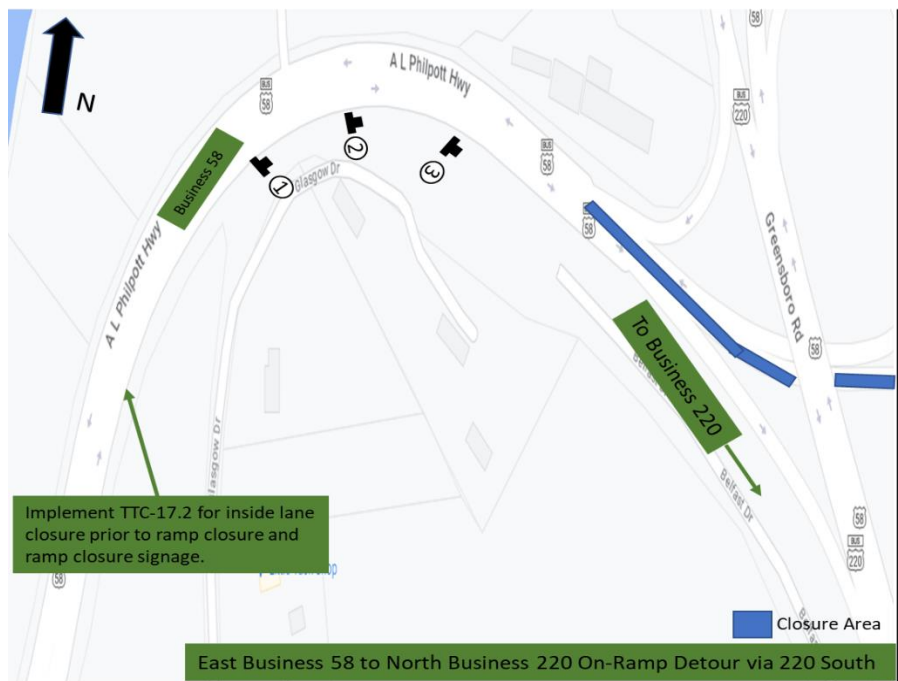


A	B	C	D	E	F	G	H	J	K	L	M	N	P	Q	R	S
48	36	.625	.875	2.25	6	8D	5	20	4	4	10	3	39.75	180°	2.25	9











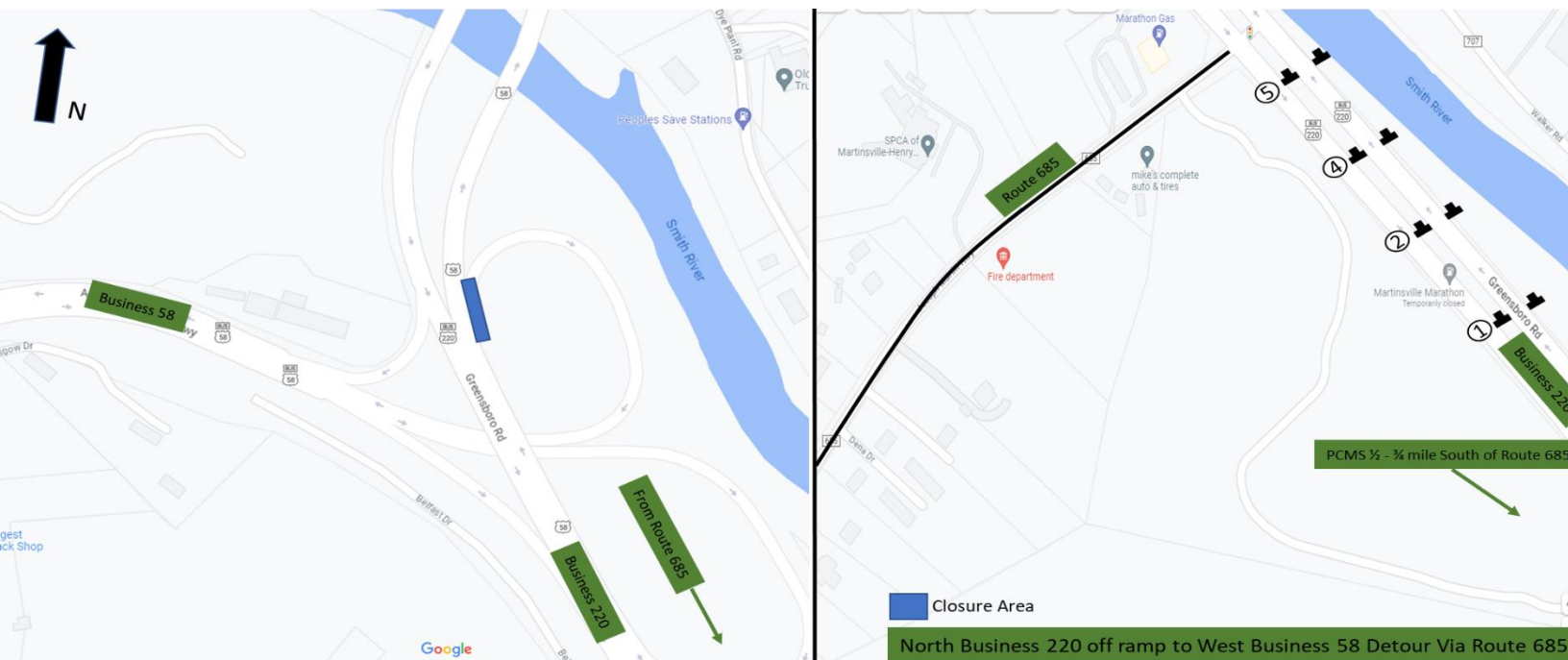
East Business 58 to 58 West Bypass On-Ramp Detour

-   
 W20-V12  
 48 X 48  
 ①
-   
 W20-2  
 48 X 48  
 ②
-   
 M4-V1  
 48 x 36  
 ③
-   
 M4-V4R  
 48 X 36  
 ④
-   
 M4-V2R  
 48 X 36  
 ⑤
-   
 M4-V3L  
 48 X 36  
 ⑥
-   
 Special Design. See attached.  
 48 X 36  
 ⑦
-   
 M4-8A  
 48 X 36  
 ⑧

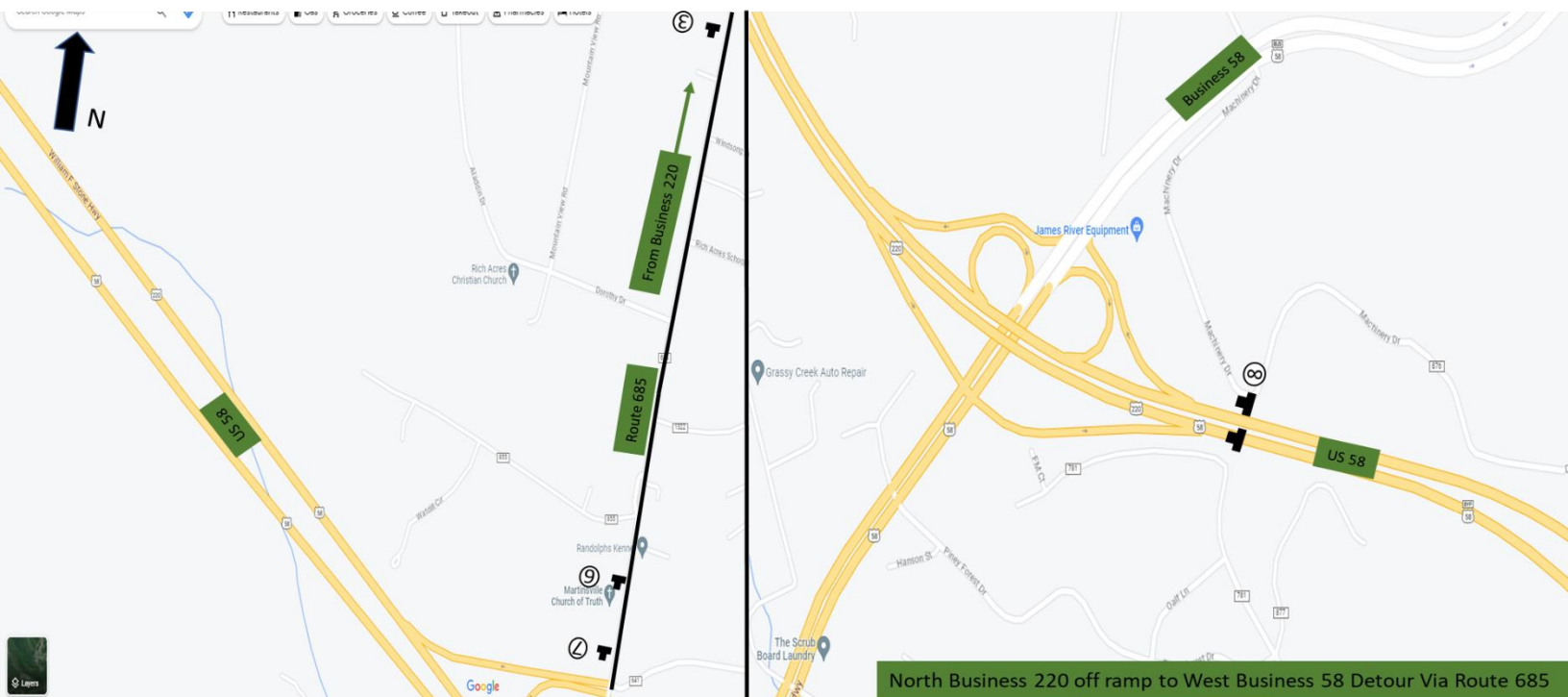


-   
 W20-V12  
 48 X 48  
 ①
-   
 W20-2  
 48 X 48  
 ②
-   
 M4-V2R  
 48 X 36  
 ③
-   
 M4-V3L  
 48 X 36  
 ④
-   
 M4-9L  
 48 X 36  
 ⑤
-   
 M4-9R  
 48 X 36  
 ⑥
-   
 M4-8A  
 48 X 36  
 ⑦

-   
 W20-V12  
 48 X 48  
 ①
-   
 W20-2  
 48 X 48  
 ②
-   
 M4-V1  
 48 X 36  
 ③
-   
 M4-V4R  
 48 X 36  
 ④
-   
 M4-V2R  
 48 X 36  
 ⑤
-   
 M4-V3L  
 48 X 36  
 ⑥
-   
 Special Design. See attached.  
 48 X 36  
 ⑦
-   
 M4-8A  
 48 X 36  
 ⑧



- |  |   |   |   |   |  |   |   |
|--|---|---|---|---|--|---|---|
| <br>ROAD WORK AHEAD | <br>DETOUR AHEAD | <br>DETOUR | <br>DETOUR | <br>DETOUR | <br>DETOUR | <br>DETOUR | <br>END DETOUR |
| W20-1<br>48 X 48   | W20-2<br>48 X 48  | M4-V1<br>48 X 36  | M4-V3L<br>48 X 36   | M4-9L<br>48 X 36  | M4-V3L<br>48 X 36  | M4-9R<br>48 X 36  | M4-8A<br>48 X 36  |
| 1  | 2   | 3   | 4   | 5   | 6  | 7   | 8   |



- |  |   |   |   |   |  |   |   |
|--|---|---|---|---|--|---|---|
| <br>ROAD WORK AHEAD | <br>DETOUR AHEAD | <br>DETOUR | <br>DETOUR | <br>DETOUR | <br>DETOUR | <br>DETOUR | <br>END DETOUR |
| W20-1<br>48 X 48   | W20-2<br>48 X 48  | M4-V1<br>48 X 36  | M4-V3L<br>48 X 36   | M4-9L<br>48 X 36  | M4-V3L<br>48 X 36  | M4-9R<br>48 X 36  | M4-8A<br>48 X 36  |
| 1  | 2   | 3   | 4   | 5   | 6  | 7   | 8   |

**STORMWATER POLLUTION PREVENTION PLAN (SWPPP)**

4/30/19

**GENERAL INFORMATION SHEET**

The information contained in the SWPPP General Information sheets is intended to comply with the requirements of VDOT's approved Annual ESC and SWM Standards and Specifications.

The SWPPP General Information sheets are to be completed and included in the construction plan set (or other such documents) for land disturbance activities that disturb an area equal to or greater than 10,000 square feet outside the Chesapeake Bay Preservation Area, or equal to or greater than 2,500 square feet in the area defined as Tidewater, Virginia in the Virginia Chesapeake Bay Preservation Act.

The VDOT RLD (as defined in the latest IIM 242) will ensure that the information shown on the SWPPP General Information sheets is updated/revised as necessary in order to reflect changes that may occur during the construction phase of the land disturbing (construction) activity. The updated/revised sheets shall be maintained with the designated record set of plans (or other such documents) for the land disturbance (construction) activity.

**SWPPP CERTIFICATION**

I certify under penalty of law that I have read and understand this document and that this document and all attachments were prepared in accordance with a system designed to assure that qualified personnel properly gathered and evaluated the information submitted. Based on my inquiry of the person or persons who manage the system, or those persons directly responsible for gathering the information, the information submitted is, to the best of my knowledge and belief, true, accurate, and complete. I am aware that there are significant penalties for submitting false information, including the possibility of fine and imprisonment for knowing violations.

I further certify that this document and all other documents related to the SWPPP, as identified on the SWPPP General Information Sheets, are maintained at the activity site, or at a location convenient to the activity site where no on-site facilities are available, and such documents will be made available for review upon request in accordance with the provisions of the General VPDES Permit for Discharges of Stormwater from Construction Activities (VAR10) when applicable. Where the SWPPP documents are not stored on-site, a copy of such documents shall be in the possession of those with day to day operational control over the implementation of the SWPPP whenever they are on site.

\*Delegated Authority Signature (1)

Signature: \_\_\_\_\_

Printed Name: \_\_\_\_\_

Date: \_\_\_\_\_



## STORMWATER POLLUTION PREVENTION PLAN (SWPPP)

4/30/19

### Acronyms

CBPA - Chesapeake Bay Preservation Act  
BMP - Best Management Practice  
DEQ - Department of Environmental Quality  
EPA - U.S. Environmental Protection Agency  
ESC - Erosion and Sediment Control  
IIM - Instructional and Informational Memorandum  
R&B - Road and Bridge  
RLD - Responsible Land Disturber  
SWPPP - Stormwater Pollution Prevention Plan  
TMDL - Total Maximum Daily Load  
VDOT - Virginia Department of Transportation  
VPDES - Virginia Pollutant Discharge Elimination System  
VSMP - Virginia Stormwater Management Program  
VESCP - Virginia Erosion and Sediment Control Program  
WLA - Waste Load Allocation  
SWM - Stormwater Management

### SECTION I GENERAL INFORMATION

1. Activity Description

Work shall consist of installing a consolidated pavement shoulder wedge shape at locations designated in plans or as directed by the Engineer. A pavement shoulder wedge is formed by a pavement shoulder wedge device to produce a consolidated wedge shaped pavement edge. Pavement shoulder wedge shall be used for Asphalt Concrete Pavement Surfaces on construction and maintenance projects that involve new asphalt placement at the edge of the roadway. Mill and fill projects that mill to the edge of pavement shall also install shoulder wedge.

2. This land disturbance (construction) activity site is located in *(insert the appropriate County/City)* and approximately *(insert the appropriate number to the nearest one hundredth of an acre)* acres will be disturbed by excavation, grading or other construction activities. **See list of Routes and Miles To: and From: in the ESC Narrative.**

**STORMWATER POLLUTION PREVENTION PLAN (SWPPP)**

4/30/19

3. (Include the following note as appropriate)

This proposed activity is exempt from coverage under the VPDES General Permit For Discharges Of Stormwater From Construction Activities (the VPDES Construction Permit) as issued by the DEQ because it is considered a routine maintenance activity (i.e., the proposed activity is intended to maintain the original line and grade, hydraulic capacity or original construction of the project or involves the paving of an existing roadway with a compacted or impervious surface and the reestablishment of associated ditches and shoulders).

\*\*4. Written Evidence of permit coverage shall be provided by the contractor for all regulated support activities located outside of VDOT right of way or easement in the form of the Construction General Permit coverage letter: (*List VPDES Permit # or Letter from VSMP Authority stating coverage not needed*)

5. The ESC plans (where applicable) for this land disturbance (construction) activity have been developed in accordance with VDOT's Approved Annual Erosion and Sediment Control Standards and Specifications as approved by the DEQ.

6. List the RLD and other responsible parties for the land disturbance activity: (required for erosion and sediment control). The following individual(s) have "delegated authority" to sign all reports required by the construction permit including the SWPPP General Information Sheets and Inspection Reports (C-107). These individual(s) has/have overall responsibility or the environmental matters for the project: (required only for permitted projects):

<b>Name</b>	<b>Position</b>	<b>Responsibility</b>
Duane Mann, P.E.	RLD	Certify the SWPPP (with date & sig.)
	Certified Inspector	Sign (C-107) Inspection Form Part 1
	Certified Inspector	Sign (C-107) Inspection Form Part 2

\*7. The name of the VDOT individual(s) responsible for the oversight inspection in accordance with IIM-LD-256 on these land disturbance construction activities as identified on these SWPPP General Information Sheets. The names will be updated and maintained with the other SWPPP documents for this land disturbance activity.

<b>VDOT Individuals</b>	<b>Position</b>	<b>Responsibility</b>
Jeff Ferguson	NPDES	NPDES coordinator responsible for the oversight inspection in accordance with IIM-LD-256
Jay Crumpacker, P.E.	Dist. Hyd. Engineer	District Hydraulic Engineer or designee(s) responsible for the review & the coordination

**STORMWATER POLLUTION PREVENTION PLAN (SWPPP)**

4/30/19

		approval of ESC SWM plan modification(s).

\*8. The ESC and P2 inspections for this land disturbing (construction) activity shall follow (*Select Schedule 1 or 2, if schedule #2 is used, void note #14*) as defined in 2020 R&B Specifications except for Section 107.16(e) 4.an Inspection Requirements Rain gauge notes apply only to Inspection Schedule 1.

9. The location of the on-site rain gage that will be used to determine the occurrence of a measurable storm event for the purposes of ESC and Pollution Prevention inspections will be provided by the contractor and identified on the record set of plans or in other appropriate SWPPP documents for this land disturbance activity: (*List location of rain gage*).

The rain gage shall be observed daily at " \_\_\_\_\_ " to determine the occurrence of a measurable storm event (i.e., 0.25 inches of rainfall or greater in a 24 hour period). A log book shall be maintained to record observation information which shall include (1) the date, (2) the time, (3) whether or not rainfall is occurring at the time of the observation, (4) the amount of accumulated rainfall in the gage, if any, and (5) whether or not an inspection is required based on the amount of accumulated rainfall in the gage.

If there is no rainfall occurring at the time of the observation, the observation information shall be noted in the log book and the rain gage emptied and replaced. An inspection is required if there is 0.25 inches or more accumulation noted in the rain gage. If there is rainfall occurring at the time of the observation, the observation information is to be noted in the log book. The rain gage is not to be emptied but left to accumulate additional rainfall until the conclusion of the rainfall event. At the conclusion of the rainfall event, an observation of the rain gage shall be made and the observation information shall be noted in the log book and the rain gage emptied and replaced. An inspection is required if there is 0.25 inches or more accumulation noted in the rain gage.

10. The following VDOT documents are applicable to

- a) Non-permitted projects in Chesapeake Bay Preservation Areas (CBPA) with 2,500 S.F.
- b) Non-permitted projects requiring a SWPPP and
- c) ESC projects > 10,000 s.f.

VDOT LD-445C: Projects that require an ESC Plan, or SWPPP.

VDOT C-107 Part I and Part II. All projects that require a permit or SWPPP.

11. If there is an excessive loading of sediment from the project (i.e. more than to be expected from the project with an implemented ESC plan) that is discovered within a local watershed with a sediment TMDL that allocates a WLA to VDOT's MS4, (see note #7) the contractor shall investigate the area of concern at the site within 24 hours of discovery and ensure all erosion and sediment control best management practices are being implemented in accordance with the permits

**STORMWATER POLLUTION PREVENTION PLAN (SWPPP)**

4/30/19

approved standards and specifications required by Part I.B of the current Construction General Permit. If corrective action is necessary, the contractor shall initiate corrective actions no later than 5 business days after the initial investigation.

12. If excessive loading of sediment from a land disturbing activity that is not the responsibility of the contractor is discovered discharging into a MS-4, the contractor shall notify the municipality with jurisdiction over erosion and sediment control activities.

\*Denotes information that is to be provided/completed by the VDOT RLD.

\*\*Denotes information that is to be provided/completed by the contractor.

**SECTION II EROSION AND SEDIMENT CONTROL**

\*\* 1. The intended sequence and timing of activities that disturb soils at the site (e.g., grubbing, excavation, grading, utilities and infrastructure installation, etc.) shall be provided by the contractor in accordance with the current edition of Section 108.03 of the VDOT R&B Specifications and shall be included with the other SWPPP documents for this land disturbance (construction) activity.

2. Directions of stormwater flow and approximate slopes anticipated after major grading activities are identified in the construction plan set (or other such documents) for this land disturbance (construction) activity.

3. Areas of soil disturbance and areas of the site which will not be disturbed are identified in the construction plan set (or other such documents) for this land disturbance (construction) activity.

4. Locations of major structural and nonstructural ESC measures intended to filter, settle or similarly remove sediment are identified in the construction plan set (or other such documents) for this land disturbance (construction) activity.

5. Locations where stabilization practices are expected to occur are identified in the construction plan set (or other such documents) for this land disturbance (construction) activity.

6. A description of interim and permanent stabilization practices for the site are identified in the applicable sections of the documents identified in the Note 1 of Section IV.

\*\* 7. A record of the dates when major grading activities occur, when construction activities temporarily or permanently cease on a portion of the site, and when stabilization measures are initiated will be provided by the contractor and maintained with the record set of plans or other SWPPP documents for this land disturbance (construction) activity: *(List how this will be tracked and the location)*

8. A description and schedule of procedures to maintain vegetation, erosion and sediment control measures and other protective measures in good and effective operating conditions are identified in the current edition of Sections 107.16 and 303.03 of the VDOT R&B Specifications.

9. Nutrients shall be applied in accordance with the current edition of Sections 603 and 604 of the VDOT Road and Bridge Specifications. Nutrients shall not be applied during rainfall events. Top

**STORMWATER POLLUTION PREVENTION PLAN (SWPPP)**

4/30/19

soil shall be applied in accordance with the current edition of section 602 of the latest Road and Bridge Specifications.

10. All engineering calculations supporting the design of erosion and sediment control measures proposed for this land disturbance (construction) activity are contained in the project drainage file located in the Salem District Pavement Management Section and will be made available for review upon request during normal business hours.

11. The temporary erosion and siltation control items shown on the ESC Plan for this land disturbing (construction) activity are intended to provide a general plan for controlling erosion and sediment within the project limits. The ESC Plan is based on field conditions at the time of plan development and an assumed sequence of construction for the project. The contractor, in conjunction with the VDOT Project Engineer and/or ESC Inspector, shall adjust the location, quantity and type of erosion and sediment control items required based on the actual field conditions encountered at the time of construction and the actual scheduling and sequencing of the construction activities. Significant changes to the proposed ESC Plan (e.g., those that require an engineering analysis, elimination of a perimeter control, change to ESC concept that would affect the quantity or direction of flow of water) shall be submitted to the applicable District Hydraulics Engineer for review and approval. Any changes to the proposed ESC Plan must be noted on the designated record set of plans which shall be retained on the project site and made available upon request during normal business hours.

12. The areas beyond the project's construction limits are to be protected from siltation. Where called for, perimeter controls such as silt fence, diversion dikes, turbidity curtains, etc. shall be installed prior to any grubbing operations or other earth moving activities.

13. Temporary earthen structures such as dikes and berms are to be stabilized immediately upon installation. Stabilization may include temporary or permanent seeding, riprap, aggregate, sod, mulching, and/or soil stabilization blankets and matting in conjunction with seeding.

14. All channel relocations are to be constructed during the earliest stage of construction and shall be constructed in accordance with all applicable permit requirements and shall be constructed in the dry wherever possible. Stabilization or vegetation shall be established before flow is redirected through the constructed area as directed by the Engineer.

15. The contractor shall plan and implement his land disturbance operations in order to:

- a. Control the volume and velocity of stormwater runoff within the site to minimize erosion.
- b. Control the peak flow rates, volume and velocity of stormwater discharges to minimize erosion at outlets and in downstream channels.
- c. Minimize the amount of soil exposed.
- d. Minimize the disturbance of steep slopes.
- e. Minimize sediment discharge from the site.
- f. Provide and maintain natural buffers around surface waters, direct stormwater runoff to vegetated areas and maximize stormwater infiltration, unless infeasible.
- g. Minimize soil compaction (except in those areas where compaction is required by the contract documents) and preserve topsoil where feasible.

**STORMWATER POLLUTION PREVENTION PLAN (SWPPP)**

4/30/19

\*\* 16. The name of the individual(s) or contractor(s) responsible for the installation and maintenance of the erosion and sediment control measures shall be supplied by the contractor and maintained with the other SWPPP documents for this land disturbance (construction) activity.

17. Soil stockpiles temporarily placed within the project area or on VDOT right of way or easement shall be identified, stabilized and protected with sediment trapping measures.

18. A construction entrance or other approved measure shall be installed at all locations where construction vehicular traffic access routes intersect a paved or a public road in order to minimize the transport of sediment by vehicular tracking onto the paved surface. Where sediment is transported onto a paved or a public road surface, the road shall be cleaned thoroughly at the end of each work day by shoveling or sweeping. Removed sediment shall be disposed of in accordance with Section 106.04 of the R&B Specifications.

19. Any variance, exception or deviation approved by DEQ must be listed below and supporting documentation (exception/variance/deviation request and DEQ approval) must be maintained with the SWPPP.

The following exceptions to the Water Quantity criteria of the VSMP Regulation have been approved by the DEQ for this land disturbance (construction) activity: *(list all approved exceptions and include a brief description of the exception, the date approved and the approving DEQ Office)*

<b>Type(1)</b>	<b>Regulation Modified(2)</b>	<b>Approval Date(3)</b>	<b>Description of Variance</b>
not applicable (n/a)			

(1) Type of modification (Variance from ESC regulations, or Deviation from published guidance)

(2) Section of Regulation or Guidance Document Modified (e.g. ESC Min. Std. 15)

(3) Date that variance/exception/deviation was approved by DEQ.

**ACRONYMS**

SWPPP - Stormwater Pollution Prevention Plan

TMDL - Total Maximum Daily Load

VDOT - Virginia Department of Transportation

VPDES - Virginia Pollutant Discharge Elimination System

VSMP - Virginia Stormwater Management Program

VESCP - Virginia Erosion and Sediment Control Program

WLA - Waste Load Allocation

SWM - Stormwater Management

**STORMWATER POLLUTION PREVENTION PLAN (SWPPP)**

4/30/19

CBPA - Chesapeake Bay Preservation Act

BMP - Best Management Practice

DEQ - Department of Environmental Quality

EPA - U.S. Environmental Protection Agency

ESC - Erosion and Sediment Control

IIM - Instructional and Informational Memorandum

R&B - Road and Bridge

RLD - Responsible Land Disturber

\* Denotes information that is to be provided/completed by the VDOT RLD.

\*\* Denotes information that is to be provided/completed by the contractor.

The SWPPP General Information sheets are to be completed and included in the construction plan set (or other such documents) for land disturbance (construction) activities that disturb an area equal to or greater than 10,000 square feet outside the Chesapeake Bay Preservation Area, or equal to or greater than 2,500 square feet in the area defined as Tidewater, Virginia in the Virginia Chesapeake Bay Preservation Act.

The VDOT RLD will ensure that the information shown on the SWPPP General Information sheets is updated/revised as necessary in order to reflect changes that may occur during the construction phase of the land disturbing (construction) activity. The updated/revised sheets shall be maintained with the designated record set of plans (or other such documents) for the land disturbance (construction) activity.

**SECTION III - POLLUTION PREVENTION PLAN**

1. The following non-stormwater discharges from this land disturbing (construction) activity and any on-site support facilities are prohibited:

- a. Wastewater from concrete washouts.
- b. Wastewater from the washout and cleanout of stucco, paint, form release oils, curing compounds and other construction materials.
- c. Fuels, oils or other pollutants used in vehicle and equipment operation and maintenance.
- d. Oils, toxic substances or hazardous substances from spills or other releases.
- e. Soaps, solvents or detergents used in equipment and vehicle washing.
- f. There shall be no discharge of floating solids or visible foam in other than trace amounts

**STORMWATER POLLUTION PREVENTION PLAN (SWPPP)**

4/30/19

2. The following non-stormwater discharges from this land disturbing (construction) activity and any on-site support facilities are allowed when discharged in compliance with the VPDES Construction Permit:

- a. Discharges from firefighting activities.
- b. Fire hydrant flushings.
- c. Waters used to wash vehicles or equipment where soaps, solvents or detergents have not been used and the wash water has been filtered, settled or similarly treated prior to discharge.
- d. Water used to control dust that has been filtered, settled or similarly treated prior to discharge.
- e. Potable water sources including uncontaminated waterline flushings managed in a manner to avoid stream impacts.
- f. Routine external building wash down where soaps, solvents or detergents have not been used and the wash water has been filtered, settled or similarly treated prior to discharge.
- g. Pavement wash waters where spills or leaks of toxic or hazardous materials have not occurred (or where all spilled or leaked material has been removed prior to washing), where soaps, solvents or detergents have not been used and where the wash water has been filtered, settled or similarly treated prior to discharge.
- h. Uncontaminated air conditioning or compressor condensate.
- i. Uncontaminated ground water or spring water.
- j. Foundation or footing drains where flows are not contaminated with process materials such as solvents.
- k. Uncontaminated excavation dewatering, including dewatering trenches and excavations that have been filtered, settled or similarly treated prior to discharge.
- l. Landscape irrigation.

\*\* 3. The contractor shall address any of his on-site operations that have a potential to generate a pollutant that may reasonably be expected to affect the quality of stormwater discharges from this land disturbance (construction) activity and shall:

- 1) Prevent and respond to leaks, spills, and other releases, including procedures for expeditiously stopping, containing, and cleaning up spills, leaks, and other releases, and procedures for reporting leaks, spills, and other releases in accordance with Section 107.16 of the VDOT Road and Bridge Specifications and the requirements within the VPDES Construction Permit.
- 2) Prevent the discharge of spilled and leaked fuels and chemicals from vehicle fueling and maintenance activities.
- 3) Prevent the discharge of soaps, solvents, detergents, and wash water from construction materials, including procedures for the clean-up of stucco, paint, form release oils, and curing compounds.



**STORMWATER POLLUTION PREVENTION PLAN (SWPPP)**

4/30/19

- 4) Minimize the discharge of pollutants from vehicle and equipment washing, wheel wash water, and other types of washing.
- 5) Direct concrete wash water into a leak-proof container or leak-proof settling basin. The container or basin shall be designed so that no overflows can occur due to inadequate sizing or precipitation. Hardened concrete wastes shall be removed and disposed of in a manner consistent with the handling of other construction wastes. Liquid concrete wastes shall be removed and disposed of in a manner consistent with the handling of other construction wash waters and shall not be discharged to surface waters.
- 6) Minimize the discharge of pollutants from storage, handling, and disposal of construction products, materials, and wastes including building products (such as asphalt sealants, copper flashing, roofing materials, adhesives, and concrete admixtures), pesticides, herbicides, insecticides, fertilizers, landscape materials, construction and domestic wastes (such as packaging materials), scrap construction materials, masonry products, timber, pipe and electrical cuttings, plastics, styrofoam, concrete, and other trash or building materials.
- 7) Prevent the discharge of fuels, oils, and other petroleum products, hazardous or toxic wastes, waste concrete and sanitary wastes.
- 8) Address any other discharge from any potential pollutant-generating activity not listed herein.
- 9) Minimize the exposure of waste materials to precipitation by closing or covering waste containers during precipitation events and at the end of the business day, or implementing other similarly effective practices. Minimization of exposure is not required in case where the exposure to precipitation will not result in a discharge of pollutants.

\* Denotes information that is to be provided/completed by the VDOT RLD.

\*\* Denotes information that is to be provided/completed by the contractor.

**STORMWATER POLLUTION PREVENTION PLAN (SWPPP)**

4/30/19

**STORMWATER POLLUTION PREVENTION PLAN (SWPPP) GENERAL INFORMATION SHEET**

The information contained in the SWPPP General Information sheets is intended to comply with the requirements of VDOT's approved Annual ESC and SWM Standards and Specifications.

The SWPPP General Information sheets are to be completed and included in the construction plan set (or other such documents) for land disturbance (construction) activities that disturb an area equal to or greater than 10,000 square feet, or equal to or greater than 2,500 square feet in the area defined as Tidewater, Virginia in the Virginia Chesapeake Bay Preservation Act.

The VDOT RLD will ensure that the information shown on the SWPPP General Information sheets is updated/revised as necessary in order to reflect changes that may occur during the construction phase of the land disturbing (construction) activity. The updated/revised sheets shall be maintained with the designated record set of plans (or other such documents) for the land disturbance (construction) activity.

**Commonwealth of Virginia -- Department of Transportation  
 Maintenance Division**

**District:** Salem

**Date:** 1/31/2024

Page 1 of 38

**Schedule:** PM-2F-24

**Henry (CO)**

**State Project Number:** PM2F-962-F24, P401

<b>Route:</b> 57 (57)	<b>Milepost From:</b> 29.68	0.18 MI. W. RTE. 647 (MOUNTAIN VALLEY RD)	
<b>Subdivision:</b>	<b>Lane:</b> B	<b>PCN:</b> M224PMF123441	<b>UPC:</b> 123441
<b>Traf Grp:</b> X	<b>Milepost To:</b> 32.69	PITTSYLVANIA COUNTY LINE	
<b>From Intersection:</b>			
<b>From Offset:</b> OMI	<b>From X/Y Coordinates:</b> ,		
<b>To Intersection:</b>			
<b>To Offset:</b> OMI	<b>To X/Y Coordinates:</b> ,		

**Public Comments:**

Item Code & Description	Detail	Len(mi)	Wid(ft)	Dep(in)	Gal/SqYd	Lbs/SqYd	Quantity	UOM
305SP20-0003 - AGR.BASE MAT.TY.I OR II NO. 21A OR21B	SHOULDER STONE ADJACENT TO SHOULDER WEDGE						509	TON
310SD20-0001 - TACK COAT	TACK COAT						5644	GAL
315SD20-0048 - ASPH. CONC. TY. BM-25.0D MAINT	WESTBOUND DEEP PATCHING - RIGHT WHEEL PATH	0.2	9	6		720	380.16	TON
315SD20-0048 - ASPH. CONC. TY. BM-25.0D MAINT	EASTBOUND DEEP PATCHING - RIGHT WHEEL PATH	0.12	9	6		720	228.1	TON
315SP20-0006 - PAVEMENT SHOULDER WEDGE PREP. CONST	PAVEMENT SHOULDER WEDGE PREP.						33264	LF
315SP20-0049 - ASPH. CONC. BMD P+VO SM-9.5D	ASPHALT QUANTITIES: PAVEMENT SHOULDER WEDGE						67.5	TON
315SP20-0049 - ASPH. CONC. BMD P+VO SM-9.5D	MAINLINE WITH ADJACENT SHOULDERS	3.15	27	2		234	5837.83	TON
315SP20-0049 - ASPH. CONC. BMD P+VO SM-9.5D	TURNING LANES						43.7	TON
315SP20-0049 - ASPH. CONC. BMD P+VO SM-9.5D	CONNECTIONS						245.7	TON
315SP20-0049 - ASPH. CONC. BMD P+VO SM-9.5D	EXTRA WIDE SHOULDERS						75.2	TON
512SD20-0046 - TEMP. PVMT MRKG TY. A, 4"	TEMPORARY LINE MARKING						56985	LF
512SD20-0047 - TEMP. PVMT MRKG TY. A, 6"	TEMPORARY LINE MARKING						56985	LF
512SX20-0005 - NS TEMP. PVMT MRKG - White TEMP. PAVE. MESS. MARK (STOP BAR 12")	TEMPORARY CONNECTION STOP BARS						79	LF
515SD20-0013 - FLEXIBLE PAVE.PLANING 0"-2"	MAINLINE WITH ADJACENT SHOULDERS	3.15	27	2			49896	SY
515SD20-0013 - FLEXIBLE PAVE.PLANING 0"-2"	CONNECTIONS						2100	SY
515SD20-0013 - FLEXIBLE PAVE.PLANING 0"-2"	EXTRA WIDE SHOULDERS						642	SY
515SD20-0013 - FLEXIBLE PAVE.PLANING 0"-2"	TURNING LANES						375	SY

**Schedule:** PM-2F-24

**Henry (CO)**

**State Project Number:** PM2F-962-F24, P401

515SD20-0015 - FLEXIBLE PAVEMENT PLANING ABOVE 4"	EASTBOUND DEEP MILLING - RIGHT WHEEL	0.12	9	6	633.6	SY
515SD20-0015 - FLEXIBLE PAVEMENT PLANING ABOVE 4"	WESTBOUND DEEP MILLING - RIGHT WHEEL PATH	0.2	9	6	1056	SY
704SD20-0007 - TYPE B CLASS I PVMT LINE MRKG 6" - White	EDGE LINE MARKING				33545	LF
704SD20-0007 - TYPE B CLASS I PVMT LINE MRKG 6" - Yellow	CENTER LINE MARKING				23440	LF
704SD20-0007 - TYPE B CLASS I PVMT LINE MRKG 6" - Yellow	CONNECTION CENTER LINE MARKING				220	LF
704SD20-0015 - TYPE B CLASS II PVMT LINE MRKG 24" - White	PREFORMED THERMO CONNECTION STOP BARS				79	LF
704SD20-0015 - TYPE B CLASS II PVMT LINE MRKG 24" - White	PREFORMED THERMO CONNECTION HATCHES				35	LF

**State Project Number:** PM2F-962-F24, P401

**Notes:**

Miscellaneous Notes

BEGIN MP COORDINATES:  
36.77714, -79.71031  
END MP COORDINATES:  
36.78321, -79.65911

Miscellaneous Notes

THE CONTRACTOR SHALL  
CONTACT THE  
CONSTRUCTION MANAGER  
AT LEAST 2 WEEKS PRIOR  
TO THE START OF PAVING  
OPERATIONS TO DETERMINE  
THE PATCHING LOCATIONS.

Miscellaneous Notes

MAINLINE & ADJACENT  
SHOULDERS TREATMENT:  
MILL 2.0" AND REPLACE  
WITH 2.0" ASPHALT  
CONCRETE, TYPE BMD P+VO  
SM-9.5D.

Miscellaneous Notes

THE MEASURED LENGTH OF  
THIS SECTION IS 3.15  
MILES.

Miscellaneous Notes

THE CONTRACTOR SHALL  
REFER TO THE PASSING  
ZONE MODIFICATION  
SKETCH INCLUDED WITHIN  
THE CONTRACT  
DOCUMENTS. CONTACT  
GARY BOWMAN AT  
540-588-8835 AT LEAST TWO  
WEEKS PRIOR TO APPLYING  
FINAL PAVEMENT MARKINGS  
TO RELOCATE NO PASSING  
ZONE PENNANTS.

Rideability Pay Factor is in effect for this item.

Miscellaneous Notes

DEEP PATCHES TREATMENT:  
MILL 6.0" AND REPLACE  
WITH 6.0" ASPHALT  
CONCRETE, TYPE BM-25.0D  
THAT SHALL BE PLACED IN  
TWO LIFTS.

Miscellaneous Notes

THE 9 FOOT DEEP PATCHES  
SHALL BE MEASURED FROM  
THE OUTER EDGE OF THE  
SHOULDER TOWARD THE  
INSIDE OF THE TRAFFIC  
LANE.

Pavement shoulder wedge is required on both sides.

State Project Number: PM2F-962-F24, P401

<b>Route:</b> 57 (R-VA SR00057EB)	<b>Milepost From:</b> 1.08	0.03 MI. E. RTE. 687
<b>Subdivision:</b>	<b>Lane:</b> B	<b>PCN:</b> M224PMF123441
<b>Traf Grp:</b> XII	<b>Milepost To:</b> 4	0.11 MI. E. RTE. 674
<b>From Intersection:</b>	<b>From X/Y Coordinates:</b>	36.75077, -80.07202
<b>From Offset:</b> OMI	<b>To Intersection:</b>	<b>To X/Y Coordinates:</b> 36.76237, -80.02363
<b>To Offset:</b> OMI		

**Public Comments:**

Item Code & Description	Detail	Len(mi)	Wid(ft)	Dep(in)	Gal/SqYd	Lbs/SqYd	Quantity	UOM
305SP20-0003 - AGR.BASE MAT.TY.I OR II NO. 21A OR21B	SHOULDER STONE ADJACENT TO SHOULDER WEDGE						471	TON
310SD20-0001 - TACK COAT	TACK COAT						7386	GAL
315SD20-0048 - ASPH. CONC. TY. BM-25.0D MAINT	DEEP PATCHING - EASTBOUND	0.35	14	6		720	1034.88	TON
315SD20-0048 - ASPH. CONC. TY. BM-25.0D MAINT	DEEP PATCHING - WESTBOUND	0.41	14	6		720	1212.29	TON
315SD20-0048 - ASPH. CONC. TY. BM-25.0D MAINT	DEEP PATCHING - WESTBOUND RIGHT WHEEL PATH	0.23	9	6		720	437.18	TON
315SP20-0006 - PAVEMENT SHOULDER WEDGE PREP. CONST	PAVEMENT SHOULDER WEDGE PREP.						30835	LF
315SP20-0049 - ASPH. CONC. BMD P+VO SM-9.5D	ASPHALT QUANTITIES: PAVEMENT SHOULDER WEDGE						63	TON
315SP20-0049 - ASPH. CONC. BMD P+VO SM-9.5D	CENTER TURNING LANES						423	TON
315SP20-0049 - ASPH. CONC. BMD P+VO SM-9.5D	MAINLINE & ADJACENT SHOULDERS	2.92	28	2		234	5612.01	TON
315SP20-0049 - ASPH. CONC. BMD P+VO SM-9.5D	CONNECTIONS						436.5	TON
315SP20-0049 - ASPH. CONC. BMD P+VO SM-9.5D	EXTRA WIDE SHOULDER						298.4	TON
315SP20-0049 - ASPH. CONC. BMD P+VO SM-9.5D	TURNING LANES						127	TON
512SD20-0046 - TEMP. PVMT MRKG TY. A, 4"	TEMPORARY LINE MARKINGS						61120	LF
512SD20-0047 - TEMP. PVMT MRKG TY. A, 6"	TEMPORARY LINE MARKINGS						61120	LF
512SX20-0005 - NS TEMP. PVMT MRKG - White TEMP. PAVE. MESS. MARK (STOP BAR 12")	TEMPORARY CONNECTIONS STOP BARS						187	LF
515SD20-0013 - FLEXIBLE PAVE.PLANING 0"-2"	MAINLINE & ADJACENT SHOULDERS	2.92	28	2			47965.87	SY
515SD20-0013 - FLEXIBLE PAVE.PLANING 0"-2"	CONNECTIONS						3730	SY
515SD20-0013 - FLEXIBLE PAVE.PLANING 0"-2"	CENTER TURNING LANES						3612	SY
515SD20-0013 - FLEXIBLE PAVE.PLANING 0"-2"	EXTRA WIDE SHOULDER						2550	SY
515SD20-0013 - FLEXIBLE PAVE.PLANING 0"-2"	TURNING LANES						1084.2	SY

**State Project Number:** PM2F-962-F24, P401

515SD20-0015 - FLEXIBLE PAVEMENT PLANING ABOVE 4"	DEEP MILLING - EASTBOUND LANE	0.35	14	6	2874.67	SY
515SD20-0015 - FLEXIBLE PAVEMENT PLANING ABOVE 4"	DEEP MILLING - WESTBOUND RIGHT WHEEL PATH	0.23	9	6	1214.4	SY
515SD20-0015 - FLEXIBLE PAVEMENT PLANING ABOVE 4"	DEEP MILLING - WESTBOUND	0.41	14	6	3367.47	SY
704SD20-0007 - TYPE B CLASS I PVMT LINE MRKG 6" - White	EDGE & TURNING LANES LINE MARKING				32800	LF
704SD20-0007 - TYPE B CLASS I PVMT LINE MRKG 6" - White	CONNECTION EDGE LINE MARKING				250	LF
704SD20-0007 - TYPE B CLASS I PVMT LINE MRKG 6" - Yellow	CONNECTION CENTER LINE MARKING				400	LF
704SD20-0007 - TYPE B CLASS I PVMT LINE MRKG 6" - Yellow	CENTER LINE MARKING				28320	LF
704SD20-0015 - TYPE B CLASS II PVMT LINE MRKG 24" - White	PREFORMED THERMO CONNECTIONS STOP BARS				187	LF
704SD20-0032 - INLAID PAVEMENT MARKER ASPHALT	INLAID PAVEMENT MARKER ASPHALT				390	EA
704SD20-0048 - PVMT SYMB MRKG SGL TURN ARR. TY B CL II - White	PREFORMED THERMO TURN ARROWS				11	EA

**State Project Number:** PM2F-962-F24, P401

**Notes:**

Miscellaneous Notes

EASTBOUND LANE DEEP  
PATCHING LOCATIONS:  
FROM MP 1.22 TO MP 1.30  
FROM MP 1.34 TO MP 1.36  
FROM MP 1.37 TO MP 1.46  
FROM MP 1.53 TO MP 1.63  
FROM MP 2.18 TO MP 2.20  
FROM MP 2.28 TO MP 2.32

WESTBOUND LANE RIGHT  
WHEEL PATH DEEP  
PATCHING LOCATIONS:  
FROM MP 3.74 TO MP 3.72  
FROM MP 2.98 TO MP 2.96  
FROM MP 2.62 TO MP 2.58  
FROM MP 2.49 TO MP 2.45  
FROM MP 1.93 TO MP 1.91  
FROM MP 1.60 TO MP 1.57  
FROM MP 1.54 TO MP 1.48

WESTBOUND LANE DEEP  
PATCHING LOCATIONS:  
FROM MP 2.40 TO MP 2.07  
FROM MP 1.32 TO MP 1.24

Miscellaneous Notes

DEEP PATCHES TREATMENT:  
MILL 6.0" AND REPLACE  
WITH 6.0" ASPHALT  
CONCRETE, TYPE BM-25.0D  
THAT SHALL BE PLACED IN  
TWO LIFTS.

Miscellaneous Notes

THE 9 FOOT DEEP PATCHES  
SHALL BE MEASURED FROM  
THE OUTER EDGE OF THE  
SHOULDER TOWARD THE  
INSIDE OF THE TRAFFIC  
LANE.



**State Project Number:** PM2F-962-F24, P401

Miscellaneous Notes

THE CONTRACTOR SHALL REFER TO THE PASSING ZONE MODIFICATION SKETCH INCLUDED WITHIN THE CONTRACT DOCUMENTS. CONTACT GARY BOWMAN AT 540-588-8835 AT LEAST TWO WEEKS PRIOR TO APPLYING FINAL PAVEMENT MARKINGS TO RELOCATE NO PASSING ZONE PENNANTS.

Miscellaneous Notes

MAINLINE, SHOULDERS, TURNING LANES AND CONNECTIONS TREATMENT: MILL 2" AND REPLACE WITH 2" ASPHALT CONCRETE, TYPE BMD P+VO SM-9.5D.

Pavement shoulder wedge is required on both sides.

Rideability Pay Factor is in effect for this item.

Miscellaneous Notes

THE DOUBLE SNOW PLOWABLE RAISED MARKERS SHALL BE REPLACED WITH A SINGLE PLASTIC INLAID MARKER PLACED BETWEEN THE YELLOW DOUBLE CENTER LINE MARKINGS.

State Project Number: PM2F-962-F24, P401

<b>Route:</b> 57 (R-VA SR00057EB)	<b>Milepost From:</b> 12.29	RAILROAD CROSSING/RTE. 701
<b>Subdivision:</b>	<b>Lane:</b> B	<b>PCN:</b> M224PMF123441 <b>UPC:</b> 123441
<b>Traf Grp:</b> XIV	<b>Milepost To:</b> 14.44	WCL MARTINSVILLE
<b>From Intersection:</b> 12.29 Miles: Field Ave PR/NP (Henry Cnty), SC-701E/W (Henry Cnty)		
<b>From Offset:</b> OMI	<b>From X/Y Coordinates:</b> 36.70132, -79.93241	
<b>To Intersection:</b> 14.44 Miles: Maint Bdy Henry Cnty/Martinsville City;		
<b>To Offset:</b> OMI	<b>To X/Y Coordinates:</b> 36.68557, -79.90289	

**Public Comments:**

Item Code & Description	Detail	Len(mi)	Wid(ft)	Dep(in)	Gal/SqYd	Lbs/SqYd	Quantity	UOM
305SP20-0003 - AGR.BASE MAT.TY.I OR II NO. 21A OR21B	SHOULDER STONE ADJACENT TO SHOULDER WEDGE						278	TON
310SD20-0001 - TACK COAT	TACK COAT						3210	GAL
315SD20-0048 - ASPH. CONC. TY. BM-25.0D MAINT	DEEP PATCHING - WESTBOUND	0.04	12	6		720	101.38	TON
315SP20-0006 - PAVEMENT SHOULDER WEDGE PREP. CONST	PAVEMENT SHOULDER WEDGE PREP.						18190	LF
315SP20-0049 - ASPH. CONC. BMD P+VO SM-9.5D	RIGHT SHOULDER @ 2.3' WIDE	0.09	2.3	2		234	14.21	TON
315SP20-0049 - ASPH. CONC. BMD P+VO SM-9.5D	LEFT SHOULDER @ 3.25' WIDE	0.05	3.25	2		234	11.15	TON
315SP20-0049 - ASPH. CONC. BMD P+VO SM-9.5D	LEFT SHOULDER @ 1.25' WIDE	0.07	1.25	2		234	6.01	TON
315SP20-0049 - ASPH. CONC. BMD P+VO SM-9.5D	RIGHT SHOULDER @ 1' WIDE	0.33	1	2		234	22.65	TON
315SP20-0049 - ASPH. CONC. BMD P+VO SM-9.5D	MAINLINE WITH ADJACENT SHOULDERS	2.15	24	2		240	3632.64	TON
315SP20-0049 - ASPH. CONC. BMD P+VO SM-9.5D	CONNECTIONS @ 2.0"						61.1	TON
315SP20-0049 - ASPH. CONC. BMD P+VO SM-9.5D	ASPHALT QUANTITIES: PAVEMENT SHOULDER WEDGE						25	TON
512SD20-0046 - TEMP. PVMT MRKG TY. A, 4"	TEMPORARY LINE MARKINGS						44038	LF
512SD20-0047 - TEMP. PVMT MRKG TY. A, 6"	TEMPORARY LINE MARKINGS						44038	LF
512SX20-0005 - NS TEMP. PVMT MRKG - White TEMP. PAVE. MESS. MARK (STOP BAR 12")	TEMPORARY CONNECTION STOP BARS						70	LF
512SX20-0005 - NS TEMP. PVMT MRKG - White TEMP. PAVE. MESS. MARK (STOP BAR 12")	TEMPORARY STOP BAR						33	LF
515SD20-0013 - FLEXIBLE PAVE.PLANING 0"-2"	RIGHT SHOULDER @ 1' WIDE	0.33	1	2			191.25	SY
515SD20-0013 - FLEXIBLE PAVE.PLANING 0"-2"	RIGHT SHOULDER @ 2.3' WIDE	0.09	2.3	2			120.09	SY
515SD20-0013 - FLEXIBLE PAVE.PLANING 0"-2"	MAINLINE WITH ADJACENT SHOULDERS	2.15	24	2			30272	SY
515SD20-0013 - FLEXIBLE PAVE.PLANING 0"-2"	LEFT SHOULDER @ 3.25' WIDE	0.05	3.25	2			102.96	SY

**State Project Number:** PM2F-962-F24, P401

515SD20-0013 - FLEXIBLE PAVE.PLANING 0"-2"	LEFT SHOULDER @ 1.25' WIDE	0.07	1.25	2	49.87	SY
515SD20-0013 - FLEXIBLE PAVE.PLANING 0"-2"	CONNECTIONS @ 2.0"				509	SY
515SD20-0015 - FLEXIBLE PAVEMENT PLANING ABOVE 4"	DEEP MILLING - WESTBOUND	0.04	12	6	281.6	SY
704SD20-0007 - TYPE B CLASS I PVMT LINE MRKG 6" - White	CONNECTIONS EDGE LINE MARKING				120	LF
704SD20-0007 - TYPE B CLASS I PVMT LINE MRKG 6" - White	EDGE LINE MARKING				22577	LF
704SD20-0007 - TYPE B CLASS I PVMT LINE MRKG 6" - Yellow	CENTER LINE MARKING				21461	LF
704SD20-0007 - TYPE B CLASS I PVMT LINE MRKG 6" - Yellow	CONNECTIONS CENTER LINE MARKING				90	LF
704SD20-0015 - TYPE B CLASS II PVMT LINE MRKG 24" - White	PREFORMED THERMO STOP BAR				33	LF
704SD20-0015 - TYPE B CLASS II PVMT LINE MRKG 24" - White	PREFORMED THERMO CONNECTION STOP BARS				70	LF
704SD20-0042 - PVMT MSG. MARK. R/R CROSSING TY. B, CL. II - White	PREFORMED THERMO CONNECTION R/R MESSAGE				1	EA
704SD20-0042 - PVMT MSG. MARK. R/R CROSSING TY. B, CL. II - White	PREFORMED THERMO R/R MESSAGE				1	EA

**State Project Number:** PM2F-962-F24, P401

**Notes:**

Rideability Pay Factor is in effect for this item.

Miscellaneous Notes

MAINLINE, SHOULDERS,  
TURNING LANE, &  
CONNECTION TREATMENT:  
MILL 2.0" AND REPAVCE  
WITH 2.0" ASPHALT  
CONCRETE, TYPE BMD P+VO  
SM-9.5D

Miscellaneous Notes

RAILROAD CROSSING  
COORDINATES:  
(36.70133, -79.93239)

Pavement shoulder wedge is required on both sides.

Miscellaneous Notes

DEEP PATCHING  
TREATMENT:  
MILL 6.0" AND REPLACE  
WITH 6.0" ASPHALT  
CONCRETE, TYPE BM-25.0D  
PLACED IN TWO LIFTS.

Miscellaneous Notes

THE CONTRACTOR SHALL  
REFER TO THE PASSING  
ZONE MODIFICATION  
SKETCH INCLUDED WITHIN  
THE CONTRACT  
DOCUMENTS. CONTACT  
GARY BOWMAN AT  
540-588-8835 AT LEAST TWO  
WEEKS PRIOR TO APPLYING  
FINAL PAVEMENT MARKINGS  
TO RELOCATE NO PASSING  
ZONE PENNANTS.

Miscellaneous Notes

WESTBOUND DEEP  
PATCHING LOCATION:  
FROM MP 12.69 TO MP 12.65

State Project Number: PM2F-962-F24, P401

<b>Route:</b> 58 (R-VA US00058WB)	<b>Milepost From:</b> 20.16	0.33 MI. W. RTE. 648
<b>Subdivision:</b>	<b>Lane:</b> W	<b>PCN:</b> M224PMF123441
<b>Traf Grp:</b> XV	<b>Milepost To:</b> 20.85	RTE. 620 (DANIEL RD)
<b>From Intersection:</b>	<b>From X/Y Coordinates:</b>	36.6741, -79.75104
<b>From Offset:</b> OMI	<b>To Intersection:</b>	<b>To X/Y Coordinates:</b> 36.67161, -79.73902
<b>To Offset:</b> OMI		

**Public Comments:**

Item Code & Description	Detail	Len(mi)	Wid(ft)	Dep(in)	Gal/SqYd	Lbs/SqYd	Quantity	UOM
305SP20-0003 - AGR.BASE MAT.TY.I OR II NO. 21A OR21B	SHOULDER STONE ADJACENT TO SHOULDER WEDGE						125	TON
310SD20-0001 - TACK COAT	TACK COAT						1430	GAL
315SD20-0015 - RUMBLE STRIP, ASPHALT CONST - Edge Line	RUMBLE STRIPS RIGHT SIDE (RS-6B)						3330	LF
315SD20-0016 - LIQ.ASPH. RUMBLE STRIP COATING CONST - Edge Line	LIQ. ASPH. COATING FOR RUMBLES - RIGHT SIDE						555	SY
315SD20-0048 - ASPH. CONC. TY. BM-25.0D MAINT	DEEP PATCHING - RIGHT LANE	0.03	12	6		720	76.03	TON
315SP20-0006 - PAVEMENT SHOULDER WEDGE PREP. CONST	PAVEMENT SHOULDER WEDGE PREP.						8131	LF
315SP20-0049 - ASPH. CONC. BMD P+VO SM-9.5D	CONNECTIONS						44.3	TON
315SP20-0049 - ASPH. CONC. BMD P+VO SM-9.5D	TURNING LANES						131	TON
315SP20-0049 - ASPH. CONC. BMD P+VO SM-9.5D	MAINLINE & ADJACENT SHOULDERS	0.69	29.5	2		234	1397.17	TON
315SP20-0049 - ASPH. CONC. BMD P+VO SM-9.5D	ASPHALT QUANTITIES: PAVEMENT SHOULDER WEDGE						16.5	TON
315SP20-0049 - ASPH. CONC. BMD P+VO SM-9.5D	CROSSOVERS						56.3	TON
512SD20-0046 - TEMP. PVMT MRKG TY. A, 4"	TEMPORARY LINE MARKINGS						10220	LF
512SD20-0047 - TEMP. PVMT MRKG TY. A, 6"	TEMPORARY LINE MARKINGS						10220	LF
512SX20-0005 - NS TEMP. PVMT MRKG - White TEMP. PAVE. MESS. MARK (STOP BAR 12")	TEMPORARY STOP BARS						90	LF
512SX20-0005 - NS TEMP. PVMT MRKG - White TEMP. PAVE. MESS. MARK (STOP BAR 12")	TEMPORARY CONNECTION STOP BAR						38	LF
515SD20-0013 - FLEXIBLE PAVE.PLANING 0"-2"	MAINLINE & ADJACENT SHOULDERS	0.69	29.5	2			11941.6	SY
515SD20-0013 - FLEXIBLE PAVE.PLANING 0"-2"	TURNING LANES						1092	SY
515SD20-0013 - FLEXIBLE PAVE.PLANING 0"-2"	CROSSOVERS						470	SY
515SD20-0013 - FLEXIBLE PAVE.PLANING 0"-2"	CONNECTIONS						370	SY
515SD20-0015 - FLEXIBLE PAVEMENT PLANING ABOVE 4"	DEEP MILLING - RIGHT LANE	0.03	12	6			211.2	SY

**State Project Number:** PM2F-962-F24, P401

704SD20-0007 - TYPE B CLASS I PVMT LINE MRKG 6" - White	CONNECTION EDGE LINE MARKING	230	LF
704SD20-0007 - TYPE B CLASS I PVMT LINE MRKG 6" - White	EDGE, SKIP & TURNING LANES LINE MARKING	6150	LF
704SD20-0007 - TYPE B CLASS I PVMT LINE MRKG 6" - Yellow	EDGE LINE MARKING	4070	LF
704SD20-0007 - TYPE B CLASS I PVMT LINE MRKG 6" - Yellow	CONNECTION CENTER LINE MARKING	120	LF
704SD20-0015 - TYPE B CLASS II PVMT LINE MRKG 24" - White	PREFORMED CONNECTION THERMO STOP BAR	38	LF
704SD20-0015 - TYPE B CLASS II PVMT LINE MRKG 24" - White	PREFORMED THERMO STOP BARS	90	LF
704SD20-0032 - INLAID PAVEMENT MARKER ASPHALT	INLAID PAVEMENT MARKER ASPHALT	46	EA
704SD20-0048 - PVMT SYMB MRKG SGL TURN ARR. TY B CL II - White	PREFORMED THERMO TURN ARROWS	2	EA
704SD20-0048 - PVMT SYMB MRKG SGL TURN ARR. TY B CL II - White	PREFORMED THERMO CONNECTION TURN ARROW	1	EA
704SD20-0051 - DBL TURN ARR.THRU/LT OR RT TY B, CL II - White	PREFORMED THERMO CONNECTION DOUBLE ARROW	1	EA
704SX20-0001 - NS PAVEMENT MARKING - White PREFORMED THERMO PAVE. LINE MARK. RUMBLE STRIPS 4"	PREFORMED THERMO RUMBLE STRIPS - 4"	500	LF
704SX20-0001 - NS PAVEMENT MARKING - White PREFORMED THERMO PAVE. LINE MARK. RUMBLE STRIPS 4"	PREFORMED THERMO TRANSVERSE RUMBLE STRIPS	450	LF

**State Project Number:** PM2F-962-F24, P401

**Notes:**

Rideability Pay Factor is in effect for this item.

Miscellaneous Notes

THERE IS NO EXISTING PHYSICAL JOINT AT THE BEGINNING OF THIS SECTION.

Miscellaneous Notes

MAINLINE, SHOULDERS, CONNECTIONS, TURNING LANES AND CROSSOVERS TREATMENT: MILL 2" AND REPLACE WITH 2" ASPHALT CONCRETE, TYPE BMD P+VO SM-9.5D.

Pavement shoulder wedge is required on both sides.

Miscellaneous Notes

THE CONTRACTOR SHALL CONTACT BADRUL AHSAN AT 540-312-7206 AT LEAST TWO WEEKS PRIOR TO INSTALLING THE RUMBLE STRIPS.

Miscellaneous Notes

FOR RUMBLE STRIP DETAILS, THE CONTRACTOR SHALL REFER TO R & B STANDARD RS-6B INCLUDED WITHIN THE CONTRACT DOCUMENTS.

Miscellaneous Notes

RIGHT LANE DEEP PATCHING LOCATION: FROM MP 20.53 TO MP 20.50 (RUTTING AT THE TRAFFIC SIGNAL)

Miscellaneous Notes

DEEP PATCHING TREATMENT: MILL 6.0" AND REPLACE WITH 6.0" ASPHALT CONCRETE, TYPE BM-25.0D.

Miscellaneous Notes

THE CONTRACTOR SHALL PLACE THE RIGHT EDGE LINE MARKING SUCH THAT THE PAVEMENT EXTENDING BEYOND THE EDGE LINE MARKING IS 1.5 FEET WIDE. THIS IS TO ENSURE THERE IS SUFFICIENT WIDTH FOR THE EDGE LINE RUMBLE STRIPS TO BE PLACED.

State Project Number: PM2F-962-F24, P401

<b>Route:</b> 58 (R-VA US00058WBBUS009)	<b>Milepost From:</b> 10.01	0.13 MI. E. FR1004
<b>Subdivision:</b>	<b>Lane:</b> W	<b>PCN:</b> M224PMF123441
<b>Traf Grp:</b> XV	<b>Milepost To:</b> 10.264	US58WB
<b>From Intersection:</b>		
<b>From Offset:</b> OMI	<b>From X/Y Coordinates:</b> 36.67969, -79.78262	
<b>To Intersection:</b> 10.2640 Miles: Ramp to William F Stone Hwy PR (Henry Cnty), US-58W, Bus US-58E Rmp 10A (9 Martinsville City); A L Philpott		
<b>To Offset:</b> OMI	<b>To X/Y Coordinates:</b> 36.67889, -79.77827	

**Public Comments:**

Item Code & Description	Detail	Len(mi)	Wid(ft)	Dep(in)	Gal/SqYd	Lbs/SqYd	Quantity	UOM
305SP20-0003 - AGR.BASE MAT.TY.I OR II NO. 21A OR21B	SHOULDER STONE ADJACENT TO SHOULDER WEDGE						21	TON
310SD20-0001 - TACK COAT	TACK COAT						465	GAL
315SD20-0015 - RUMBLE STRIP, ASPHALT CONST - Edge Line	RUMBLE STRIPS - RIGHT SIDE (RS-6B)						1345	LF
315SD20-0016 - LIQ.ASPH. RUMBLE STRIP COATING CONST - Edge Line	LIQ. ASPH. COATING FOR RUMBLES - RIGHT SIDE						225	SY
315SP20-0006 - PAVEMENT SHOULDER WEDGE PREP. CONST	PAVEMENT SHOULDER WEDGE PREP.						1342	LF
315SP20-0049 - ASPH. CONC. BMD P+VO SM-9.5D	CROSSOVER						38	TON
315SP20-0049 - ASPH. CONC. BMD P+VO SM-9.5D	MAINLINE & ADJACENT SHOULDERS	0.254	31	2		234	540.47	TON
315SP20-0049 - ASPH. CONC. BMD P+VO SM-9.5D	ASPHALT QUANTITIES: PAVEMENT SHOULDER WEDGE						3	TON
512SD20-0046 - TEMP. PVMT MRKG TY. A, 4"	TEMPORARY LINE MARKINGS						3025	LF
512SD20-0047 - TEMP. PVMT MRKG TY. A, 6"	TEMPORARY LINE MARKINGS						3025	LF
512SD20-0048 - TEMP. PVMT MRKG TY. A, 8"	TEMPORARY GORE AREA LINE MARKINGS						265	LF
512SD20-0049 - TEMP. PVMT MRKG TY. A, 12"	TEMPORARY GORE AREA LINE MARKINGS						265	LF
515SD20-0013 - FLEXIBLE PAVE.PLANING 0"-2"	MAINLINE & ADJACENT SHOULDERS	0.254	31	2			4619.41	SY
515SD20-0013 - FLEXIBLE PAVE.PLANING 0"-2"	CROSSOVER						325	SY
704SD20-0007 - TYPE B CLASS I PVMT LINE MRKG 6" - White	EDGE & SKIP LINE MARKINGS						1680	LF
704SD20-0007 - TYPE B CLASS I PVMT LINE MRKG 6" - Yellow	EDGE LINE MARKING						1345	LF
704SD20-0009 - TYPE B CLASS I PVMT LINE MRKG 12" - White	GORE LINE MARKING						265	LF
704SD20-0032 - INLAID PAVEMENT MARKER ASPHALT	INLAID PAVEMENT MARKER ASPHALT						24	EA



**State Project Number:** PM2F-962-F24, P401

**Notes:**

Rideability Pay Factor is in effect for this item.

Pavement shoulder wedge is required on left side only.

Miscellaneous Notes

MAINLINE, SHOULDERS, AND  
CROSSOVERS TREATMENT:  
MILL 2" AND REPLACE WITH  
2" ASPHALT CONCRETE,  
TYPE BMD P+VO SM-9.5D.

Miscellaneous Notes

THE CONTRACTOR SHALL  
PAVE THE RIGHT SHOULDER  
WITH THE ADJACENT RIGHT  
TRAFFIC LANE. IF NOT  
POSSIBLE, THEN ONLY THE  
PORTION OF THE RIGHT  
SHOULDER WHERE EDGE  
LINE RUMBLE STRIPS WILL  
BE PLACED SHALL BE PAVED  
WITH THE ADJACENT RIGHT  
TRAFFIC LANE.

Miscellaneous Notes

THERE IS NO EXISTING  
PHYSICAL JOINT AT THE  
BEGINNING OF THIS  
SECTION.

Miscellaneous Notes

THE CONTRACTOR SHALL  
CONTACT BADRUL AHSAN AT  
540-312-7206 AT LEAST TWO  
WEEKS PRIOR TO  
INSTALLING THE RUMBLE  
STRIPS.

Miscellaneous Notes

FOR RUMBLE STRIP  
DETAILS, THE CONTRACTOR  
SHALL REFER TO R & B  
STANDARD RS-6B INCLUDED  
WITHIN THE CONTRACT  
DOCUMENTS.

State Project Number: PM2F-962-F24, P401

<b>Route:</b> 58 (R-VA US00058EBBUS009RMP002.00B)	<b>Milepost From:</b> 0	US58EBBUS009
<b>Subdivision:</b>	<b>Lane:</b> B	<b>PCN:</b> M224PMF123441 <b>UPC:</b> 123441
<b>Traf Grp:</b> XIV	<b>Milepost To:</b> 0.36	US220NBBUS004
<b>From Intersection:</b> 0 Miles: Rte Gap; A L Philpott Hwy NP (Henry Cnty), Bus US-58E (9 Martinsville City), Bus US-58E Rmp 2A (9 Martinsville City)		
<b>From Offset:</b> 0MI	<b>From X/Y Coordinates:</b> 36.6615, -79.88364	
<b>To Intersection:</b> 0.36 Miles: Greensboro Rd NP (Henry Cnty), Bus US-58E (9 Martinsville City), Bus US-220N (4 Martinsville City)		
<b>To Offset:</b> 0MI	<b>To X/Y Coordinates:</b> 36.65985, -79.8814	

**Public Comments:**

Item Code & Description	Detail	Len(mi)	Wid(ft)	Dep(in)	Gal/SqYd	Lbs/SqYd	Quantity	UOM
310SD20-0001 - TACK COAT	TACK COAT						480	GAL
315SP20-0049 - ASPH. CONC. BMD P+VO SM-9.5D	MAINLINE & ADJACENT SHOULDERS	0.36	24.4	2		234	602.93	TON
512SD20-0046 - TEMP. PVMT MRKG TY. A, 4"	TEMPORARY LINE MARKINGS						3540	LF
512SD20-0047 - TEMP. PVMT MRKG TY. A, 6"	TEMPORARY LINE MARKINGS						3540	LF
512SD20-0048 - TEMP. PVMT MRKG TY. A, 8"	TEMPORARY GORE AREA LINE MARKING						45	LF
512SD20-0049 - TEMP. PVMT MRKG TY. A, 12"	TEMPORARY GORE AREA LINE MARKING						45	LF
515SD20-0013 - FLEXIBLE PAVE.PLANING 0"-2"	MAINLINE & ADJACENT SHOULDERS	0.36	24.4	2			5153.28	SY
704SD20-0007 - TYPE B CLASS I PVMT LINE MRKG 6" - White	EDGE LINE MARKING						1770	LF
704SD20-0007 - TYPE B CLASS I PVMT LINE MRKG 6" - Yellow	EDGE LINE MARKING						1770	LF
704SD20-0009 - TYPE B CLASS I PVMT LINE MRKG 12" - White	GORE AREA LINE MARKING						45	LF

**Notes:**

Miscellaneous Notes

WORK WILL BE ALLOWED NIGHTLY 7:00 PM TO 6:00 AM SUNDAY THROUGH FRIDAY.

Miscellaneous Notes

THE SECTION MAIN TREATMENT: MILL 2.0" AND REPLACE WITH 2.0" ASPHALT CONCRETE, TYPE BMD P +VO SM-9.5D.

State Project Number: PM2F-962-F24, P401

<b>Route:</b> 58 (R-VA US00058WB RMP271.00A)	<b>Milepost From:</b> 0	US58WB/US58WBBUS009
<b>Subdivision:</b>	<b>Lane:</b> B	<b>PCN:</b> M224PMF123441 <b>UPC:</b> 123441
<b>Traf Grp:</b>	<b>Milepost To:</b> 0.52	US58WB
<b>From Intersection:</b> 0 Miles: Rte Gap; A L Philpott Hwy PR (Henry Cnty), Bus US-58W (9 Martinsville City), US-58W		
<b>From Offset:</b> 0MI	<b>From X/Y Coordinates:</b> 36.67889, -79.77827	
<b>To Intersection:</b> 0.52 Miles: Rte Gap; William F Stone Hwy PR (Henry Cnty), US-58W, Bus US-58E Rmp 10A (9 Martinsville City)		
<b>To Offset:</b> 0MI	<b>To X/Y Coordinates:</b> 36.67717, -79.78642	

**Public Comments:**

Item Code & Description	Detail	Len(mi)	Wid(ft)	Dep(in)	Gal/SqYd	Lbs/SqYd	Quantity	UOM
310SD20-0001 - TACK COAT	TACK COAT						925	GAL
315SP20-0049 - ASPH. CONC. BMD P+VO SM-9.5D	RIGHT SHOULDER @ 8' WIDE	0.05	8	2		234	27.46	TON
315SP20-0049 - ASPH. CONC. BMD P+VO SM-9.5D	RIGHT SHOULDER @ 7' WIDE	0.24	7	2		234	115.32	TON
315SP20-0049 - ASPH. CONC. BMD P+VO SM-9.5D	RIGHT SHOULDER @ 8.5' WIDE	0.05	8.5	2		234	29.17	TON
315SP20-0049 - ASPH. CONC. BMD P+VO SM-9.5D	RIGHT SHOULDER @ 6.2' WIDE	0.12	6.2	2		234	51.07	TON
315SP20-0049 - ASPH. CONC. BMD P+VO SM-9.5D	LEFT SHOULDER @ 3.2' WIDE	0.27	3.2	2		234	59.3	TON
315SP20-0049 - ASPH. CONC. BMD P+VO SM-9.5D	LEFT SHOULDER @ 10.8' WIDE	0.13	10.8	2		234	96.37	TON
315SP20-0049 - ASPH. CONC. BMD P+VO SM-9.5D	LEFT SHOULDER @ 7.5' WIDE	0.07	7.5	2		234	36.04	TON
315SP20-0049 - ASPH. CONC. BMD P+VO SM-9.5D	MAINLINE @ 24.7 FEET WIDE	0.09	24.7	2		234	152.59	TON
315SP20-0049 - ASPH. CONC. BMD P+VO SM-9.5D	MAINLINE @ 16.3 FEET WIDE	0.31	16.3	2		234	346.84	TON
315SP20-0049 - ASPH. CONC. BMD P+VO SM-9.5D	GORE AREAS @ 2"						39	TON
315SP20-0049 - ASPH. CONC. BMD P+VO SM-9.5D	MAINLINE @ 18 FEET WIDE	0.02	18	2		234	24.71	TON
315SP20-0049 - ASPH. CONC. BMD P+VO SM-9.5D	MAINLINE @ 20 FEET WIDE	0.02	20	2		234	27.46	TON
315SP20-0049 - ASPH. CONC. BMD P+VO SM-9.5D	MAINLINE @ 22.5 FEET WIDE	0.03	22.5	2		234	46.33	TON
512SD20-0046 - TEMP. PVMT MRKG TY. A, 4"	TEMPORARY LINE MARKINGS						5961	LF
512SD20-0047 - TEMP. PVMT MRKG TY. A, 6"	TEMPORARY LINE MARKINGS						5961	LF
512SD20-0048 - TEMP. PVMT MRKG TY. A, 8"	TEMPORARY GORE AREA LINE MARKING						500	LF
512SD20-0049 - TEMP. PVMT MRKG TY. A, 12"	TEMPORARY GORE AREA LINE MARKING						500	LF
515SD20-0013 - FLEXIBLE PAVE.PLANING 0"-2"	MAINLINE @ 24.7 FEET WIDE	0.09	24.7	2			1304.16	SY
515SD20-0013 - FLEXIBLE PAVE.PLANING 0"-2"	RIGHT SHOULDER @ 7' WIDE	0.24	7	2			985.6	SY

**State Project Number:** PM2F-962-F24, P401

515SD20-0013 - FLEXIBLE PAVE.PLANING 0"-2"	RIGHT SHOULDER @ 8.5' WIDE	0.05	8.5	2	249.33	SY
515SD20-0013 - FLEXIBLE PAVE.PLANING 0"-2"	RIGHT SHOULDER @ 8' WIDE	0.05	8	2	234.67	SY
515SD20-0013 - FLEXIBLE PAVE.PLANING 0"-2"	MAINLINE @ 16.3 FEET WIDE	0.31	16.3	2	2964.43	SY
515SD20-0013 - FLEXIBLE PAVE.PLANING 0"-2"	MAINLINE @ 18 FEET WIDE	0.02	18	2	211.2	SY
515SD20-0013 - FLEXIBLE PAVE.PLANING 0"-2"	MAINLINE @ 22.5 FEET WIDE	0.03	22.5	2	396	SY
515SD20-0013 - FLEXIBLE PAVE.PLANING 0"-2"	MAINLINE @ 20 FEET WIDE	0.02	20	2	234.67	SY
515SD20-0013 - FLEXIBLE PAVE.PLANING 0"-2"	RIGHT SHOULDER @ 6.2' WIDE	0.12	6.2	2	436.48	SY
515SD20-0013 - FLEXIBLE PAVE.PLANING 0"-2"	LEFT SHOULDER @ 3.2' WIDE	0.27	3.2	2	506.88	SY
515SD20-0013 - FLEXIBLE PAVE.PLANING 0"-2"	LEFT SHOULDER @ 10.8' WIDE	0.13	10.8	2	823.68	SY
515SD20-0013 - FLEXIBLE PAVE.PLANING 0"-2"	LEFT SHOULDER @ 7.5' WIDE	0.07	7.5	2	308	SY
515SD20-0013 - FLEXIBLE PAVE.PLANING 0"-2"	GORE AREAS @ 2"				328	SY
704SD20-0007 - TYPE B CLASS I PVMT LINE MRKG 6" - White	EDGE & SKIP LINE MARKINGS				3400	LF
704SD20-0007 - TYPE B CLASS I PVMT LINE MRKG 6" - Yellow	EDGE LINE MARKING				2561	LF
704SD20-0009 - TYPE B CLASS I PVMT LINE MRKG 12" - White	GORE AREA LINE MARKING				500	LF
704SD20-0032 - INLAID PAVEMENT MARKER ASPHALT	INLAID PAVEMENT MARKER ASPHALT				33	EA

**Notes:**

Miscellaneous Notes

WORK WILL BE ALLOWED  
 NIGHTLY 7:00 PM TO 6:00  
 AM SUNDAY THROUGH  
 FRIDAY.

Miscellaneous Notes

CONCRETE BRIDGE SHALL  
 NOT BE PAVED.

Miscellaneous Notes

THE SECTION MAIN  
 TREATMENT:  
 MILL 2.0" AND REPLACE  
 WITH 2.0" ASPHALT  
 CONCRETE, TYPE BMD P  
 +VO SM-9.5D.

Miscellaneous Notes

THERE IS NO EXISTING  
 PHYSICAL JOINT AT THE  
 END OF THIS SECTION.

State Project Number: PM2F-962-F24, P401

<b>Route:</b> 58 (R-VA US00058WB)	<b>Milepost From:</b> 18.59	US58WBBUS009
<b>Subdivision:</b>	<b>Lane:</b> W	<b>PCN:</b> M224PMF123441 <b>UPC:</b> 123441
<b>Traf Grp:</b> XV	<b>Milepost To:</b> 20.16	0.33 MI. W. RTE. 648
<b>From Intersection:</b> 18.59 Miles: Rte Gap; Ramp to William F Stone Hwy PR (Henry Cnty), US-58W, Bus US-58E Rmp 10A (9 Martinsville City); A L		
<b>From Offset:</b> OMI	<b>From X/Y Coordinates:</b>	36.67889, -79.77827
<b>To Intersection:</b>		
<b>To Offset:</b> OMI	<b>To X/Y Coordinates:</b>	36.6741, -79.75104

**Public Comments:**

Item Code & Description	Detail	Len(mi)	Wid(ft)	Dep(in)	Gal/SqYd	Lbs/SqYd	Quantity	UOM
305SP20-0003 - AGR.BASE MAT.TY.I OR II NO. 21A OR21B	SHOULDER STONE ADJACENT TO SHOULDER WEDGE						233	TON
310SD20-0001 - TACK COAT	TACK COAT						4120	GAL
315SD20-0015 - RUMBLE STRIP, ASPHALT CONST - Edge Line	RUMBLE STRIPS - RIGHT SIDE (RS-6B)						8290	LF
315SD20-0016 - LIQ.ASPH. RUMBLE STRIP COATING CONST - Edge Line	LIQ. ASPH. COATING FOR RUMBLES - RIGHT SIDE						1385	SY
315SD20-0048 - ASPH. CONC. TY. BM-25.0D MAINT	DEEP PATCHING - RIGHT LANE RIGHT WHEEL PATH	0.66	9	6		720	1254.53	TON
315SD20-0048 - ASPH. CONC. TY. BM-25.0D MAINT	DEEP PATCHING - RIGHT LANE	0.06	14	6		720	177.41	TON
315SP20-0006 - PAVEMENT SHOULDER WEDGE PREP. CONST	PAVEMENT SHOULDER WEDGE PREP.						15206	LF
315SP20-0049 - ASPH. CONC. BMD P+VO SM-9.5D	EXTRA WIDE RIGHT SHOULDER	0.32	12	2		234	263.58	TON
315SP20-0049 - ASPH. CONC. BMD P+VO SM-9.5D	CROSSOVERS						86.2	TON
315SP20-0049 - ASPH. CONC. BMD P+VO SM-9.5D	MAINLINE & ADJACENT SHOULDERS	1.57	29.5	2		234	3179.06	TON
315SP20-0049 - ASPH. CONC. BMD P+VO SM-9.5D	TURNING LANES						194.5	TON
315SP20-0049 - ASPH. CONC. BMD P+VO SM-9.5D	ASPHALT QUANTITIES: PAVEMENT SHOULDER WEDGE						31	TON
315SP20-0049 - ASPH. CONC. BMD P+VO SM-9.5D	DECEL LANE						165	TON
512SD20-0046 - TEMP. PVMT MRKG TY. A, 4"	TEMPORARY LINE MARKINGS						20195	LF
512SD20-0047 - TEMP. PVMT MRKG TY. A, 6"	TEMPORARY LINE MARKINGS						20195	LF
512SD20-0048 - TEMP. PVMT MRKG TY. A, 8"	TEMPORARY GORE AREA & DOTTED LANE LINE MARKINGS						1125	LF
512SD20-0049 - TEMP. PVMT MRKG TY. A, 12"	TEMPORARY GORE AREA & DOTTED LANE LINE MARKINGS						1125	LF
515SD20-0013 - FLEXIBLE PAVE.PLANING 0"-2"	EXTRA WIDE RIGHT SHOULDER	0.32	12	2			2252.8	SY

**State Project Number:** PM2F-962-F24, P401

515SD20-0013 - FLEXIBLE PAVE.PLANING 0"-2"	MAINLINE & ADJACENT SHOULDERS	1.57	29.5	2	27171.47	SY
515SD20-0013 - FLEXIBLE PAVE.PLANING 0"-2"	CROSSOVERS				718	SY
515SD20-0013 - FLEXIBLE PAVE.PLANING 0"-2"	DECEL LANE				1410	SY
515SD20-0013 - FLEXIBLE PAVE.PLANING 0"-2"	TURNING LANES				1620	SY
515SD20-0015 - FLEXIBLE PAVEMENT PLANING ABOVE 4"	DEEP MILLING - RIGHT LANE	0.06	14	6	492.8	SY
515SD20-0015 - FLEXIBLE PAVEMENT PLANING ABOVE 4"	DEEP MILLING - RIGHT LANE RIGHT WHEEL PATH	0.66	9	6	3484.8	SY
704SD20-0007 - TYPE B CLASS I PVMT LINE MRKG 6" - White	EDGE, SKIP & TURNING LANES LINE MARKINGS				11760	LF
704SD20-0007 - TYPE B CLASS I PVMT LINE MRKG 6" - Yellow	EDGE LINE MARKING				8435	LF
704SD20-0009 - TYPE B CLASS I PVMT LINE MRKG 12" - White	DOTTED LANE LINE AT DECEL LANE				575	LF
704SD20-0009 - TYPE B CLASS I PVMT LINE MRKG 12" - White	GORE LINE MARKING				550	LF
704SD20-0032 - INLAID PAVEMENT MARKER ASPHALT	INLAID PAVEMENT MARKER ASPHALT				138	EA

**State Project Number:** PM2F-962-F24, P401

**Notes:**

Rideability Pay Factor is in effect for this item.  
Pavement shoulder wedge is required on both sides.  
Miscellaneous Notes

MAINLINE, SHOULDERS,  
TURNING LANES AND  
CROSSOVERS TREATMENT:  
MILL 2" AND REPLACE WITH  
2" ASPHALT CONCRETE,  
TYPE BMD P+VO SM-9.5D.

Miscellaneous Notes

FOR THE PART OF SECTION  
WITH EXTRA WIDE RIGHT  
SHOULDER:  
THE CONTRACTOR SHALL  
PAVE THE PORTION OF THE  
RIGHT SHOULDER WHERE  
THE EDGE LINE RUMBLE  
STRIP WILL BE PLACED  
WITH THE ADJACENT RIGHT  
TRAFFIC LANE.

Miscellaneous Notes

DEEP PATCHING  
TREATMENT:  
MILL 6.0" AND REPLACE  
WITH 6.0" ASPHALT  
CONCRETE, TYPE BM-25.0D.

Miscellaneous Notes

THE 9 FOOT DEEP PATCHES  
SHALL BE MEASURED FROM  
THE OUTER EDGE OF THE  
SHOULDER TOWARD THE  
INSIDE OF THE RIGHT  
TRAFFIC LANE.

**State Project Number:** PM2F-962-F24, P401

Miscellaneous Notes

RIGHT LANE RIGHT WHEEL  
PATCH DEEP PATCHING  
LOCATIONS:  
FROM MP 20.05 TO MP 19.99  
FROM MP 19.90 TO MP 19.88  
FROM MP 19.82 TO MP 19.78  
FROM MP 19.65 TO MP 19.60  
FROM MP 19.41 TO MP 18.92

RIGHT LANE DEEP PATCHING  
LOCATIONS:  
FROM MP 19.76 TO MP 19.70

Miscellaneous Notes

THERE IS NO EXISTING  
PHYSICAL JOINT AT THE  
END OF THIS SECTION.

Miscellaneous Notes

THE CONTRACTOR SHALL  
CONTACT BADRUL AHSAN AT  
540-312-7206 AT LEAST TWO  
WEEKS PRIOR TO  
INSTALLING THE RUMBLE  
STRIPS.

Miscellaneous Notes

FOR RUMBLE STRIP  
DETAILS, THE CONTRACTOR  
SHALL REFER TO R & B  
STANDARD RS-6B INCLUDED  
WITHIN THE CONTRACT  
DOCUMENTS.

Miscellaneous Notes

PLEASE REFER TO R & B  
STANDARD PM-2 INCLUDED  
IN THE CONTRACT  
DOCUMENTS FOR PROPER  
PLACEMENT OF THE  
INTERCHANGE LANE DROPS  
LINE MARKINGS.



**Schedule:** PM-2F-24

**Henry (CO)**

**State Project Number:** PM2F-962-F24, P401

Miscellaneous Notes

FOR THE PORTION OF THIS SECTION WITH NARROW RIGHT SHOULDER: THE CONTRACTOR SHALL PLACE THE RIGHT EDGE LINE MARKING SUCH THAT THE PAVEMENT EXTENDING BEYOND THE EDGE LINE MARKING IS 1.5 FEET WIDE. THIS IS TO ENSURE THERE IS SUFFICIENT WIDTH FOR THE EDGE LINE RUMBLE STRIPS TO BE PLACED.

State Project Number: PM2F-962-F24, P401

<b>Route:</b> 58 (R-VA US00058EBBUS009RMP010.00A)	<b>Milepost From:</b> 0	US58EBBUS009
<b>Subdivision:</b>	<b>Lane:</b> B	<b>PCN:</b> M224PMF123441
<b>Traf Grp:</b>	<b>Milepost To:</b> 0.16	US58WB
<b>From Intersection:</b> 0 Miles: A L Philpott Hwy NP (Henry Cnty), Bus US-58E (9 Martinsville City)		
<b>From Offset:</b> 0MI	<b>From X/Y Coordinates:</b> 36.68002, -79.78574	
<b>To Intersection:</b> 0.16 Miles: Rte Gap; William F Stone Hwy PR (Henry Cnty), US-58W, US-58W Rmp 271A		
<b>To Offset:</b> 0MI	<b>To X/Y Coordinates:</b> 36.67717, -79.78642	

**Public Comments:**

Item Code & Description	Detail	Len(mi)	Wid(ft)	Dep(in)	Gal/SqYd	Lbs/SqYd	Quantity	UOM
310SD20-0001 - TACK COAT	TACK COAT						265	GAL
315SP20-0049 - ASPH. CONC. BMD P+VO SM-9.5D	MAINLINE & ADJACENT SHOULDERS	0.16	28	2		234	307.51	TON
512SD20-0046 - TEMP. PVMT MRKG TY. A, 4"	TEMPORARY LINE MARKINGS						1690	LF
512SD20-0047 - TEMP. PVMT MRKG TY. A, 6"	TEMPORARY LINE MARKINGS						1690	LF
512SD20-0048 - TEMP. PVMT MRKG TY. A, 8"	TEMPORARY GORE AREA LINE MARKING						450	LF
512SD20-0049 - TEMP. PVMT MRKG TY. A, 12"	TEMPORARY GORE AREA LINE MARKING						450	LF
515SD20-0013 - FLEXIBLE PAVE.PLANING 0"-2"	MAINLINE & ADJACENT SHOULDERS	0.16	28	2			2628.27	SY
704SD20-0007 - TYPE B CLASS I PVMT LINE MRKG 6" - White	EDGE & SKIP LINE MARKINGS						845	LF
704SD20-0007 - TYPE B CLASS I PVMT LINE MRKG 6" - Yellow	EDGE LINE MARKING						845	LF
704SD20-0009 - TYPE B CLASS I PVMT LINE MRKG 12" - White	GORE AREA LINE MARKING						450	LF
704SD20-0032 - INLAID PAVEMENT MARKER ASPHALT	INLAID PAVEMENT MARKER ASPHALT						20	EA

**Notes:**

Miscellaneous Notes

WORK WILL BE ALLOWED NIGHTLY 7:00 PM TO 6:00 AM SUNDAY THROUGH FRIDAY.

Miscellaneous Notes

THE SECTION MAIN TREATMENT: MILL 2.0" AND REPLACE WITH 2.0" ASPHALT CONCRETE, TYPE BMD P +VO SM-9.5D.

Miscellaneous Notes

THERE IS NO EXISTING PHYSICAL JOINT AT THE END OF THIS SECTION.

State Project Number: PM2F-962-F24, P401

<b>Route:</b> 220 (R-VA US00220NBBUS004RMP003.00A)	<b>Milepost From:</b> 0	US58EBBUS009
<b>Subdivision:</b>	<b>Lane:</b> B	<b>PCN:</b> M224PMF123441
<b>Traf Grp:</b> XIV	<b>Milepost To:</b> 0.26	US58WBBUS009
<b>From Intersection:</b> 0 Miles: Greensboro Rd NP (Henry Cnty), Bus US-58E (9 Martinsville City), Bus US-220N (4 Martinsville City)		
<b>From Offset:</b> 0MI	<b>From X/Y Coordinates:</b> 36.66219, -79.88277	
<b>To Intersection:</b> 0.26 Miles: Rte Gap; A L Philpott Hwy PR (Henry Cnty), Bus US-58W (9 Martinsville City), Bus US-220S Rmp 3A (4 Martinsville City)		
<b>To Offset:</b> 0MI	<b>To X/Y Coordinates:</b> 36.66165, -79.88389	

**Public Comments:**

Item Code & Description	Detail	Len(mi)	Wid(ft)	Dep(in)	Gal/SqYd	Lbs/SqYd	Quantity	UOM
310SD20-0001 - TACK COAT	TACK COAT						373	GAL
315SP20-0049 - ASPH. CONC. BMD P+VO SM-9.5D	MAINLINE & ADJACENT SHOULDERS	0.26	24.4	2		234	435.45	TON
512SD20-0046 - TEMP. PVMT MRKG TY. A, 4"	TEMPORARY LINE MARKINGS						2746	LF
512SD20-0047 - TEMP. PVMT MRKG TY. A, 6"	TEMPORARY LINE MARKINGS						2746	LF
512SD20-0048 - TEMP. PVMT MRKG TY. A, 8"	TEMPORARY GORE AREA LINE MARKING						45	LF
512SD20-0049 - TEMP. PVMT MRKG TY. A, 12"	TEMPORARY GORE AREA LINE MARKING						45	LF
515SD20-0013 - FLEXIBLE PAVE.PLANING 0"-2"	MAINLINE & ADJACENT SHOULDERS	0.26	24.4	2			3721.81	SY
704SD20-0007 - TYPE B CLASS I PVMT LINE MRKG 6" - White	EDGE LINE MARKING						1373	LF
704SD20-0007 - TYPE B CLASS I PVMT LINE MRKG 6" - Yellow	EDGE LINE MARKING						1373	LF
704SD20-0009 - TYPE B CLASS I PVMT LINE MRKG 12" - White	GORE AREA LINE MARKING						45	LF

**Notes:**

Miscellaneous Notes

WORK WILL BE ALLOWED NIGHTLY 7:00 PM TO 6:00 AM SUNDAY THROUGH FRIDAY.

Miscellaneous Notes

THE SECTION MAIN TREATMENT: MILL 2.0" AND REPLACE WITH 2.0" ASPHALT CONCRETE, TYPE BMD P +VO SM-9.5D.

State Project Number: PM2F-962-F24, P401

<b>Route:</b> 220 (R-VA US00220NB)	<b>Milepost From:</b> 0	NORTH CAROLINA STATE LINE
<b>Subdivision:</b>	<b>Lane:</b> N	<b>PCN:</b> M224PMF123441 <b>UPC:</b> 123441
<b>Traf Grp:</b> XV	<b>Milepost To:</b> 3.65	0.60 MI. N. RTE. 688 & C5US-220
<b>From Intersection:</b> 0 Miles: Maint Bdy Henry Cnty; Greensboro Rd NP (Henry Cnty)		
<b>From Offset:</b> OMI	<b>From X/Y Coordinates:</b> 36.54269, -79.91061	
<b>To Intersection:</b>		
<b>To Offset:</b> OMI	<b>To X/Y Coordinates:</b> 36.57795, -79.86439	

**Public Comments:**

Item Code & Description	Detail	Len(mi)	Wid(ft)	Dep(in)	Gal/SqYd	Lbs/SqYd	Quantity	UOM
305SP20-0003 - AGR.BASE MAT.TY.I OR II NO. 21A OR21B	SHOULDER STONE ADJACENT TO SHOULDER WEDGE						306	TON
310SD20-0001 - TACK COAT	TACK COAT						8570	GAL
315SD20-0015 - RUMBLE STRIP, ASPHALT CONST - Edge Line	EDGE RUMBLE STRIP - LEFT SIDE (RS-6B)						15682	LF
315SD20-0015 - RUMBLE STRIP, ASPHALT CONST - Edge Line	EDGE RUMBLE STRIP - RIGHT SIDE (RS-6B)						19272	LF
315SD20-0016 - LIQ.ASPH. RUMBLE STRIP COATING CONST - Edge Line	LIQ. ASPH. COATING FOR RUMBLES - BOTH SIDES						5826	SY
315SD20-0048 - ASPH. CONC. TY. BM-25.0D MAINT	DEEP PATCHING - RIGHT LANE RIGHT WHEEL PATH	0.94	9	6		720	1786.75	TON
315SD20-0048 - ASPH. CONC. TY. BM-25.0D MAINT	DEEP PATCHING - RIGHT LANE	0.09	12	6		720	228.1	TON
315SP20-0006 - PAVEMENT SHOULDER WEDGE PREP. CONST	PAVEMENT SHOULDER WEDGE PREP.						20027	LF
315SP20-0049 - ASPH. CONC. BMD P+VO SM-9.5D	ASPHALT QUANTITIES: PAVEMENT SHOULDER WEDGE						41.3	TON
315SP20-0049 - ASPH. CONC. BMD P+VO SM-9.5D	MAINLINE & ADJACENT SHOULDERS	3.65	33	2		234	8267.69	TON
315SP20-0049 - ASPH. CONC. BMD P+VO SM-9.5D	TURNING LANES						201.1	TON
315SP20-0049 - ASPH. CONC. BMD P+VO SM-9.5D	CONNECTIONS						82	TON
315SP20-0049 - ASPH. CONC. BMD P+VO SM-9.5D	CROSSOVERS						176	TON
512SD20-0046 - TEMP. PVMT MRKG TY. A, 4"	TEMPORARY LINE MARKINGS						44181	LF
512SD20-0047 - TEMP. PVMT MRKG TY. A, 6"	TEMPORARY LINE MARKINGS						44181	LF
515SD20-0013 - FLEXIBLE PAVE.PLANING 0"-2"	MAINLINE & ADJACENT SHOULDERS	3.65	33	2			70664	SY
515SD20-0013 - FLEXIBLE PAVE.PLANING 0"-2"	CONNECTIONS						680	SY
515SD20-0013 - FLEXIBLE PAVE.PLANING 0"-2"	TURNING LANES						1676	SY
515SD20-0013 - FLEXIBLE PAVE.PLANING 0"-2"	CROSSOVERS						1465	SY
515SD20-0015 - FLEXIBLE PAVEMENT PLANING ABOVE 4"	DEEP MILLING - RIGHT LANE RIGHT WHEEL PATH	0.94	9	6			4963.2	SY

**State Project Number:** PM2F-962-F24, P401

515SD20-0015 - FLEXIBLE PAVEMENT PLANING ABOVE 4"	DEEP MILLING - RIGHT LANE	0.09	12	6	633.6	SY
704SD20-0032 - INLAID PAVEMENT MARKER ASPHALT	INLAID PAVEMENT MARKER ASPHALT				242	EA
704SD20-0048 - PVMT SYMB MRKG SGL TURN ARR. TY B CL II - White	PREFORMED THERMO TURN ARROWS				4	EA
704SX20-0001 - NS PAVEMENT MARKING - White POLYUREA TY.B CL.VII PVMT LINE MRKG 6"	EDGE, SKIP & TURNING LANES LINE MARKINGS				24909	LF
704SX20-0001 - NS PAVEMENT MARKING - Yellow POLYUREA TY.B CL.VII PVMT LINE MRKG 6"	EDGE LINE MARKING				19272	LF

**State Project Number:** PM2F-962-F24, P401

**Notes:**

Miscellaneous Notes

THE 9 FOOT DEEP PATCHES SHALL BE MEASURED FROM THE OUTER EDGE OF THE RIGHT LANE TOWARD THE INSIDE OF THE RIGHT LANE.

Pavement shoulder wedge is required on both sides.

Miscellaneous Notes

MAINLINE, SHOULDERS, TURNING LANES AND CROSSEVERS TREATMENT: MILL 2" AND REPLACE WITH 2" ASPHALT CONCRETE, TYPE SM-9.5D (BMD P+VO).

Miscellaneous Notes

CONNECTIONS TO BE PAVED ARE ROUTES 844, 844, 971 & 734.

Rideability Pay Factor is in effect for this item.

Miscellaneous Notes

WORK ZONE WILL EXTEND INTO NORTH CAROLINA. CONTRACTOR SHALL CONTACT NCDOT: JEREMY DELAPP, COUNTY MAINTENANCE ENGINEER, AT 336-520-6100 AT LEAST 2 WEEKS PRIOR TO BEGINNING WORK.

Miscellaneous Notes

FOR RUMBLE STRIP DETAILS, THE CONTRACTOR SHALL REFER TO R & B STANDARD RS-6B INCLUDED WITHIN THE CONTRACT DOCUMENTS.

Miscellaneous Notes

THE CONTRACTOR SHALL PAVE THE SHOULDERS WITH ITS ADJACENT TRAFFIC LANE. IF NOT POSSIBLE, THEN THE PORTION OF THE SHOULDER WHERE EDGE LINE RUMBLE STRIPS WILL BE PLACED SHALL BE PAVED WITH THE ADJACENT TRAFFIC LANE.

**State Project Number:** PM2F-962-F24, P401

Miscellaneous Notes

DEEP PATCHES TREATMENT:  
MILL 6.0" AND REPLACE  
WITH 6.0" ASPHALT  
CONCRETE, TYPE BM-25.0D  
THAT SHALL BE PLACED IN  
TWO LIFTS.

Miscellaneous Notes

RIGHT LANE RIGHT WHEEL  
PATH DEEP PATCHING  
LOCATIONS:  
FROM MP 0.28 TO MP 0.30  
FROM MP 0.48 TO MP 0.72  
FROM MP 0.77 TO MP 0.90  
FROM MP 0.99 TO MP 1.04  
FROM MP 1.07 TO MP 1.13  
FROM MP 1.41 TO MP 1.50  
FROM MP 1.85 TO MP 1.90  
FROM MP 2.07 TO MP 2.09  
FROM MP 2.35 TO MP 2.37  
FROM MP 2.54 TO MP 2.80

RIGHT LANE DEEP PATCHING  
LOCATIONS:  
FROM MP 0.34 TO MP 0.37  
FROM MP 1.60 TO MP 1.66

Miscellaneous Notes

THE 6" POLYUREA LINE  
MARKING SHALL BE PLACED  
IN ACCORDANCE TO THE  
ROAD AND BRIDGE  
SPECIFICATIONS SECTION  
246.03(e) - TYPE B, CLASSVII  
MARKINGS.

State Project Number: PM2F-962-F24, P401

<b>Route:</b> 220 (R-VA US00220NB)	<b>Milepost From:</b> 3.65	0.60 MI. N. RTE. 688 & C5US-220
<b>Subdivision:</b>	<b>Lane:</b> N	<b>PCN:</b> M224PMF123441 <b>UPC:</b> 123441
<b>Traf Grp:</b> XVI	<b>Milepost To:</b> 6.66	US-220NBUS/S. END BRIDGE OVER US220
<b>From Intersection:</b>		
<b>From Offset:</b> 0.6MI	<b>From X/Y Coordinates:</b> 36.57797, -79.86435	
<b>To Intersection:</b> 6.66 Miles: Ramp to William F Stone Hwy NP (Henry Cnty), US-58E; Ramp from Greensboro Rd PR (Henry Cnty), Bus US-220S (4		
<b>To Offset:</b> 0MI	<b>To X/Y Coordinates:</b> 36.62186, -79.85997	

**Public Comments:**

Item Code & Description	Detail	Len(mi)	Wid(ft)	Dep(in)	Gal/SqYd	Lbs/SqYd	Quantity	UOM
305SP20-0003 - AGR.BASE MAT.TY.I OR II NO. 21A OR21B	SHOULDER STONE ADJACENT TO SHOULDER WEDGE						332	TON
310SD20-0001 - TACK COAT	TACK COAT						8011	GAL
315SD20-0015 - RUMBLE STRIP, ASPHALT CONST - Edge Line	RUMBLE STRIPS - RIGHT SIDE (RS-6B)						16474	LF
315SD20-0016 - LIQ.ASPH. RUMBLE STRIP COATING CONST - Edge Line	LIQ. ASPH. COATING FOR RUMBLES - RIGHT SIDE						2746	SY
315SD20-0048 - ASPH. CONC. TY. BM-25.0D MAINT	DEEP PATCHING - RIGHT LANE	0.22	14	6		720	650.5	TON
315SD20-0048 - ASPH. CONC. TY. BM-25.0D MAINT	DEEP PATCHING - RIGHT LANE RIGHT WHEEL PATH	1.09	9	6		720	2071.87	TON
315SP20-0006 - PAVEMENT SHOULDER WEDGE PREP. CONST	PAVEMENT SHOULDER WEDGE PREP.						21669	LF
315SP20-0049 - ASPH. CONC. BMD P+VO SM-9.5D	EXTRA WIDE RIGHT SHOULDER	0.25	3	2		234	51.48	TON
315SP20-0049 - ASPH. CONC. BMD P+VO SM-9.5D	MAINLINE & ADJACENT SHOULDERS	3.12	28	2		234	5996.39	TON
315SP20-0049 - ASPH. CONC. BMD P+VO SM-9.5D	ASPHALT QUANTITIES: PAVEMENT SHOULDER WEDGE						45	TON
315SP20-0049 - ASPH. CONC. BMD P+VO SM-9.5D	CONNECTIONS						338	TON
315SP20-0049 - ASPH. CONC. BMD P+VO SM-9.5D	CROSSOVERS						251	TON
315SP20-0049 - ASPH. CONC. BMD P+VO SM-9.5D	TURNING LANES						1007	TON
512SD20-0046 - TEMP. PVMT MRKG TY. A, 4"	TEMPORARY LINE MARKINGS						34738	LF
512SD20-0047 - TEMP. PVMT MRKG TY. A, 6"	TEMPORARY LINE MARKINGS						34738	LF
512SX20-0005 - NS TEMP. PVMT MRKG - White TEMP. PAVE. MESS. MARK (STOP BAR 12")	TEMPORARY CONNECTIONS STOP BARS						260	LF
512SX20-0005 - NS TEMP. PVMT MRKG - White TEMP. PAVE. MESS. MARK (STOP BAR 12")	TEMPORARY STOP BARS						230	LF
515SD20-0013 - FLEXIBLE PAVE.PLANING 0"-2"	MAINLINE & ADJACENT SHOULDERS	3.12	28	2			51251.2	SY
515SD20-0013 - FLEXIBLE PAVE.PLANING 0"-2"	EXTRA WIDE RIGHT SHOULDER	0.25	3	2			440	SY



**State Project Number:** PM2F-962-F24, P401

515SD20-0013 - FLEXIBLE PAVE.PLANING 0"-2"	TURNING LANES				8385	SY
515SD20-0013 - FLEXIBLE PAVE.PLANING 0"-2"	CONNECTIONS				2815	SY
515SD20-0013 - FLEXIBLE PAVE.PLANING 0"-2"	CROSSOVERS				2090	SY
515SD20-0015 - FLEXIBLE PAVEMENT PLANING ABOVE 4"	DEEP MILLING - RIGHT LANE RIGHT WHEEL PATH	1.09	9	6	5755.2	SY
515SD20-0015 - FLEXIBLE PAVEMENT PLANING ABOVE 4"	DEEP MILLING - RIGHT LANE	0.22	14	6	1806.93	SY
704SD20-0007 - TYPE B CLASS I PVMT LINE MRKG 6" - White	CONNECTIONS EDGE LINE MARKING				960	LF
704SD20-0007 - TYPE B CLASS I PVMT LINE MRKG 6" - White	EDGE, SKIP & TURNING LANES LINE MARKINGS				20445	LF
704SD20-0007 - TYPE B CLASS I PVMT LINE MRKG 6" - Yellow	EDGE LINE MARKING				14293	LF
704SD20-0007 - TYPE B CLASS I PVMT LINE MRKG 6" - Yellow	CONNECTIONS CENTER LINE MARKING				920	LF
704SD20-0015 - TYPE B CLASS II PVMT LINE MRKG 24" - White	PREFORMED THERMO STOP BARS				230	LF
704SD20-0015 - TYPE B CLASS II PVMT LINE MRKG 24" - White	PREFORMED THERMO CONNECTIONS STOP BARS				260	LF
704SD20-0015 - TYPE B CLASS II PVMT LINE MRKG 24" - Yellow	PREFORMED THERMO HATCHES @ RTE. 87 INTERSECTION				70	LF
704SD20-0032 - INLAID PAVEMENT MARKER ASPHALT	INLAID PAVEMENT MARKER ASPHALT				205	EA
704SD20-0048 - PVMT SYMB MRKG SGL TURN ARR. TY B CL II - White	PREFORMED THERMO CONNECTIONS TURN ARROWS				3	EA
704SD20-0048 - PVMT SYMB MRKG SGL TURN ARR. TY B CL II - White	PREFORMED THERMO TURN ARROWS				10	EA
704SD20-0051 - DBL TURN ARR.THUR/LT OR RT TY B, CL II - White	PREFORMED THERMO CONNECTIONS DOUBLE ARROW				1	EA
704SD20-0124 - PVMT MSG. MARK. "SCHOOL" TY B, CL II, 10' - White	PREFORMED THERMO SCHOOL MESSAGE				1	EA
704SX20-0001 - NS PAVEMENT MARKING - White PREFORMED THERMO PAVE. LINE MARK. RUMBLE STRIPS 4"	PREFORMED THERMO TRANSVERSE RUMBLE STRIPS				100	LF

**State Project Number:** PM2F-962-F24, P401

**Notes:**

Pavement shoulder wedge is required on both sides.

Miscellaneous Notes

THE CONTRACTOR SHALL  
END PAVING AT THE SOUTH  
END OF THE BRIDGE OVER  
US220/US58 WITH THE  
FOLLOWING COORDINATE:  
(36.62232, -79.85991)

Miscellaneous Notes

THE CONTRACTOR SHALL  
PLACE THE RIGHT EDGE  
LINE MARKING SUCH THAT  
THE PAVEMENT EXTENDING  
BEYOND THE EDGE LINE  
MARKING IS 1.5 FEET WIDE.  
THIS IS TO ENSURE THERE  
IS SUFFICIENT WIDTH FOR  
THE EDGE LINE RUMBLE  
STRIPS TO BE PLACED.

Miscellaneous Notes

MEASURED LENGTH OF THIS  
SECTION IS 3.12 MILES

Miscellaneous Notes

RIGHT LANE RIGHT WHEEL  
PATH DEEP PATCHING  
LOCATIONS:  
FROM MP 3.98 TO MP 4.04  
FROM MP 4.55 TO MP 4.68  
FROM MP 5.06 TO MP 5.20  
FROM MP 5.39 TO MP 5.60  
FROM MP 5.63 TO MP 5.90  
FROM MP 5.94 TO MP 6.02  
FROM MP 6.23 TO MP 6.33  
FROM MP 6.39 TO MP 6.49

RIGHT LANE DEEP PATCHING  
LOCATIONS:  
FROM MP 3.61 TO MP 3.70  
FROM MP 6.57 TO MP 6.70

Rideability Pay Factor is in effect for this item.

Miscellaneous Notes

THE CONTRACTOR SHALL  
CONTACT BADRUL AHSAN AT  
540-312-7206 AT LEAST TWO  
WEEKS PRIOR TO  
INSTALLING THE RUMBLE  
STRIPS.

**State Project Number:** PM2F-962-F24, P401

Miscellaneous Notes

DEEP PATCHES TREATMENT:  
MILL 6.0" AND REPLACE  
WITH 6.0" ASPHALT  
CONCRETE, TYPE BM-25.0D  
THAT SHALL BE PLACED IN  
TWO LIFTS.

Miscellaneous Notes

THE 9 FOOT DEEP PATCHES  
SHALL BE MEASURED FROM  
THE OUTER EDGE OF THE  
RIGHT SHOULDER TOWARD  
THE INSIDE OF THE RIGHT  
LANE.

Miscellaneous Notes

MAINLINE, SHOULDERS,  
TURNING LANES AND  
CROSSOVERS TREATMENT:  
MILL 2" AND REPLACE WITH  
2" ASPHALT CONCRETE,  
TYPE BMD P+VO SM-9.5D.

Miscellaneous Notes

FOR RUMBLE STRIP  
DETAILS, THE CONTRACTOR  
SHALL REFER TO R & B  
STANDARD RS-6B INCLUDED  
WITHIN THE CONTRACT  
DOCUMENTS.

State Project Number: PM2F-962-F24, P401

<b>Route:</b> 58 (R-VA US00058WB)	<b>Milepost From:</b> 29.06	RTE. 697 (MIDWAY DR.)		
<b>Subdivision:</b>	<b>Lane:</b> W	<b>PCN:</b> M224PMF123441	<b>UPC:</b> 123441	
<b>Traf Grp:</b> XIII	<b>Milepost To:</b> 31.72	HENRY COUNTY LINE		
<b>From Intersection:</b> 29.06 Miles: SC-697S (Patrick Cnty)				
<b>From Offset:</b> 0MI	<b>From X/Y Coordinates:</b>		36.59336, -80.09402	
<b>To Intersection:</b> 31.72 Miles: Maint Bdy Henry Cnty/Patrick Cnty;				
<b>To Offset:</b> 0MI	<b>To X/Y Coordinates:</b>		36.60592, -80.05047	

**Public Comments:**

Item Code & Description	Detail	Len(mi)	Wid(ft)	Dep(in)	Gal/SqYd	Lbs/SqYd	Quantity	UOM
310SD20-0001 - TACK COAT	TACK COAT						6630	GAL
315SD20-0015 - RUMBLE STRIP, ASPHALT CONST - Edge Line	RUMBLE STRIP RIGHT SIDE (RS-6B)						14045	LF
315SD20-0015 - RUMBLE STRIP, ASPHALT CONST - Edge Line	RUMBLE STRIP LEFT SIDE (RS-6B)						2815	LF
315SD20-0016 - LIQ.ASPH. RUMBLE STRIP COATING CONST - Edge Line	LIQ. ASPH. COATING FOR RUMBLES - BOTH SIDES						2810	SY
315SD20-0048 - ASPH. CONC. TY. BM-25.0D MAINT	DEEP PATCHING - RIGHT LANE	0.13	13	6		714	353.95	TON
315SP20-0049 - ASPH. CONC. BMD P+VO SM-9.5D	RIGHT SHOULDER	2.66	9	2		234	1643.24	TON
315SP20-0049 - ASPH. CONC. BMD P+VO SM-9.5D	LEFT SHOULDER @ 5.0' WIDE	0.53	5	2		234	181.9	TON
315SP20-0049 - ASPH. CONC. BMD P+VO SM-9.5D	TURNING LANES	1.07	12				866.3	TON
315SP20-0049 - ASPH. CONC. BMD P+VO SM-9.5D	CROSSOVERS						66.2	TON
315SP20-0049 - ASPH. CONC. BMD P+VO SM-9.5D	MAINLINE	2.66	26	2		230	4665.99	TON
515SD20-0013 - FLEXIBLE PAVE.PLANING 0"-2"	LEFT SHOULDER @ 5.0' WIDE	0.53	5	2			1563.47	SY
515SD20-0013 - FLEXIBLE PAVE.PLANING 0"-2"	RIGHT SHOULDER	2.66	9	2			14044.8	SY
515SD20-0013 - FLEXIBLE PAVE.PLANING 0"-2"	MAINLINE	2.66	26	2			40573.87	SY
515SD20-0013 - FLEXIBLE PAVE.PLANING 0"-2"	CROSSOVERS						575	SY
515SD20-0013 - FLEXIBLE PAVE.PLANING 0"-2"	TURNING LANES	1.07	12				7533	SY
515SD20-0015 - FLEXIBLE PAVEMENT PLANING ABOVE 4"	DEEP MILLING - RIGHT LANE	0.13	13	6			991.47	SY
704SD20-0032 - INLAID PAVEMENT MARKER ASPHALT	INLAID PAVEMENT MARKER ASPHALT						176	EA

**State Project Number:** PM2F-962-F24, P401

**Notes:**

Rideability Pay Factor is in effect for this item.

Miscellaneous Notes

RIGHT LANE DEEP PATCHING  
LOCATION:  
FROM MP 31.57 TO MP 31.44

Miscellaneous Notes

FOR RUMBLE STRIP  
DETAILS, THE CONTRACTOR  
SHALL REFER TO R & B  
STANDARD RS-6B INCLUDED  
WITHIN THE CONTRACT  
DOCUMENTS.

Miscellaneous Notes

THE CONTRACTOR SHALL  
PAVE THE SHOULDERS WITH  
ITS ADJACENT TRAFFIC  
LANE. IF NOT POSSIBLE,  
THEN THE PORTION OF THE  
SHOULDER WHERE EDGE  
LINE RUMBLE STRIPS WILL  
BE PLACED SHALL BE PAVED  
WITH THE ADJACENT  
TRAFFIC LANE.

Miscellaneous Notes

DEEP PATCHES TREATMENT:  
MILL 6.0" AND REPLACE  
WITH 6.0" ASPHALT  
CONCRETE, TYPE BM-25.0D  
THAT SHALL BE PLACED IN  
TWO LIFTS.

Miscellaneous Notes

THE CONTRACTOR SHALL  
CONTACT BADRUL AHSAN AT  
540-312-7206 AT LEAST TWO  
WEEKS PRIOR TO  
INSTALLING THE RUMBLE  
STRIPS.

Miscellaneous Notes

CONNECTIONS ARE NOT TO  
EB TREATED.

Miscellaneous Notes

MAINLINE, SHOULDERS,  
TURNING LANES AND  
CROSSOVERS TREATMENT:  
MILL 2" AND REPLACE WITH  
2" ASPHALT CONCRETE,  
TYPE SM-9.5D (BMD P+VO).

**Schedule:** PM-2F-24

**Patrick (CO)**

**State Project Number:** PM2F-962-F24, P401

Miscellaneous Notes

THE NEW PERMANENT LINE  
MARKINGS TO BE APPLIED  
ON THE FINAL SURFACE  
LAYER SHALL MATCH THE  
EXACT LOCATION OF THE  
EXISTING LINE MARKINGS  
PRIOR TO PAVING.

State Project Number: PM2F-962-F24, P401

Schedule Totals

Item	Quantity	UOM
305SP20-0003 - AGR.BASE MAT.TY.I OR II NO. 21A OR21B	2275	TON
310SD20-0001 - TACK COAT	47509	GAL
315SD20-0015 - RUMBLE STRIP, ASPHALT CONST - Edge Line	81253	LF
315SD20-0016 - LIQ.ASPH. RUMBLE STRIP COATING CONST - Edge Line	13547	SY
315SD20-0048 - ASPH. CONC. TY. BM-25.0D MAINT	9993.13	TON
315SP20-0006 - PAVEMENT SHOULDER WEDGE PREP. CONST	148664	LF
315SP20-0049 - ASPH. CONC. BMD P+VO SM-9.5D	49426.82	TON
512SD20-0046 - TEMP. PVMT MRKG TY. A, 4"	288439	LF
512SD20-0047 - TEMP. PVMT MRKG TY. A, 6"	288439	LF
512SD20-0048 - TEMP. PVMT MRKG TY. A, 8"	2430	LF
512SD20-0049 - TEMP. PVMT MRKG TY. A, 12"	2430	LF
512SX20-0005 - NS TEMP. PVMT MRKG - White TEMP. PAVE. MESS. MARK (STOP BAR 12")	987	LF
515SD20-0013 - FLEXIBLE PAVE.PLANING 0"-2"	419433.32	SY
515SD20-0015 - FLEXIBLE PAVEMENT PLANING ABOVE 4"	27766.94	SY
704SD20-0007 - TYPE B CLASS I PVMT LINE MRKG 6" - White	137905	LF
704SD20-0007 - TYPE B CLASS I PVMT LINE MRKG 6" - Yellow	109663	LF
704SD20-0009 - TYPE B CLASS I PVMT LINE MRKG 12" - White	2430	LF
704SD20-0015 - TYPE B CLASS II PVMT LINE MRKG 24" - White	1022	LF
704SD20-0015 - TYPE B CLASS II PVMT LINE MRKG 24" - Yellow	70	LF
704SD20-0032 - INLAID PAVEMENT MARKER ASPHALT	1274	EA
704SD20-0042 - PVMT MSG. MARK. R/R CROSSING TY. B, CL. II - White	2	EA
704SD20-0048 - PVMT SYMB MRKG SGL TURN ARR. TY B CL II - White	31	EA

**Schedule:** PM-2F-24

**State Project Number:** PM2F-962-F24, P401

704SD20-0051 - DBL TURN ARR.THRU/LT OR RT TY B, CL II - White	2	EA
704SD20-0124 - PVMT MSG. MARK. "SCHOOL" TY B, CL II, 10' - White	1	EA
704SX20-0001 - NS PAVEMENT MARKING - White POLYUREA TY.B CL.VII PVMT LINE MRKG 6"	24909	LF
704SX20-0001 - NS PAVEMENT MARKING - White PREFORMED THERMO PAVE. LINE MARK. RUMBLE STRIPS 4"	1050	LF
704SX20-0001 - NS PAVEMENT MARKING - Yellow POLYUREA TY.B CL.VII PVMT LINE MRKG 6"	19272	LF

### Schedule Notes

ROUTE WIDTHS MAY BE VARIABLE AND WIDTH LISTED IS AN AVERAGE USED FOR ESTIMATING PURPOSES ONLY. ACTUAL TREATMENT WIDTHS SHOULD MATCH THE EXISTING ROADWAY WIDTHS.

CONCRETE BRIDGE DECKS SHALL NOT RECEIVE TREATMENT UNLESS OTHERWISE INDICATED WITHIN THE CONTRACT LINE ITEM.

BRIDGE DECKS WITH ASPHALT OVERLAY ARE TO BE TREATED, UNLESS OTHERWISE INDICATED WITHIN THE CONTRACT LINE ITEM.

THE ASPHALT OVERLAY SHALL BE PLACED IN A MANNER THAT DOES NOT BLOCK THE DRAINS THROUGH GAPS IN THE RAILING.

PASSING ZONES SHALL BE REMARKED THE SAME AS EXISTING UNLESS OTHERWISE INDICATED WITHIN THE CONTRACT LINE ITEM.

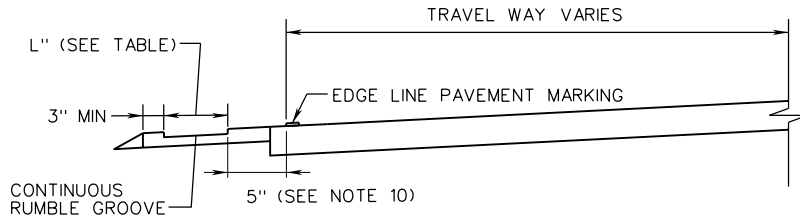
THE SPACE BETWEEN THE PARALLEL YELLOW CENTER LINES SHALL BE 7" WIDE IF RAISED PAVEMENT MARKERS ARE PRESENT BETWEEN THE TWO PARALLEL LINES. PLEASE REFER TO R & B DRAWINGS PM-8 AND PM-9.

THE PAVING CONTRACTOR SHALL COORDINATE WITH ALL MUNICIPALITIES AND AUTHORITIES THAT MAINTAIN THE UTILITIES. IT SHALL BE THE PAVING CONTRACTOR'S RESPONSIBILITY TO ENSURE THAT ALL UTILITY MANHOLE FRAMES, GRATES, AND COVERS MATCH THE FINAL SURFACE GRADE. ANY COSTS AND TIME ASSOCIATED WITH THE COORDINATION OF INVOLVED UTILITIES, WITH THE PROCUREMENT OF MATERIALS (RISERS, GRATES, COVERS, ETC.) AND WITH THE INSTALLATION OF SUCH MATERIALS SHALL BE INCIDENTAL TO THE COSTS OF OTHER BID ITEMS.

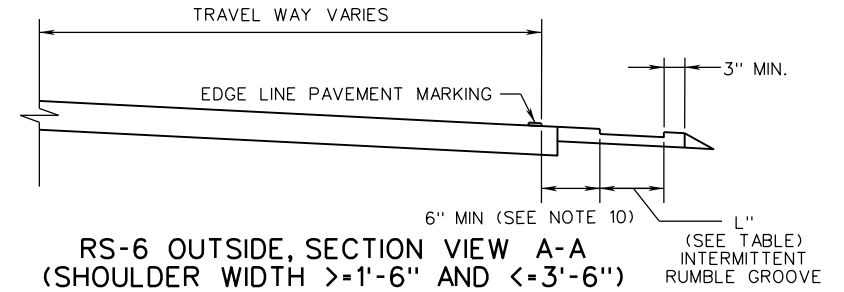
TEMPORARY TYPE A PAVEMENT MARKING PAY ITEMS MAY USE EITHER TYPE A, CLASS I OR TYPE A, CLASS II MATERIALS; OR MAY USE FTPMS AS PER SP704-000100-06. WHEN TYPE A, CLASS II MATERIAL IS USED, IT WILL BE AT NO ADDITIONAL COST TO THE DEPARTMENT.

Allowable Work Hours for ramp closures on all detoured ramps in this schedule will be daily from 7PM-6AM unless otherwise directed by the engineer.

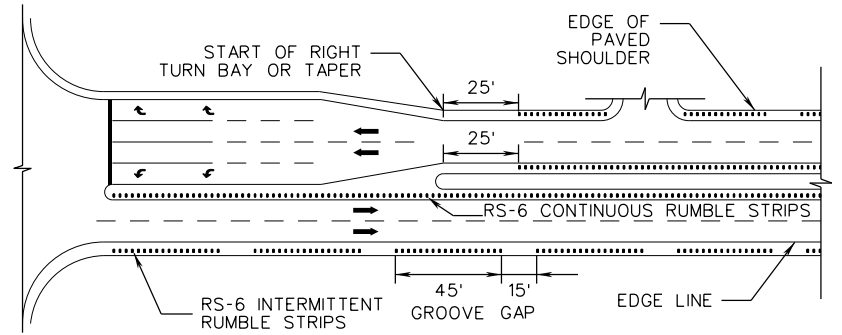
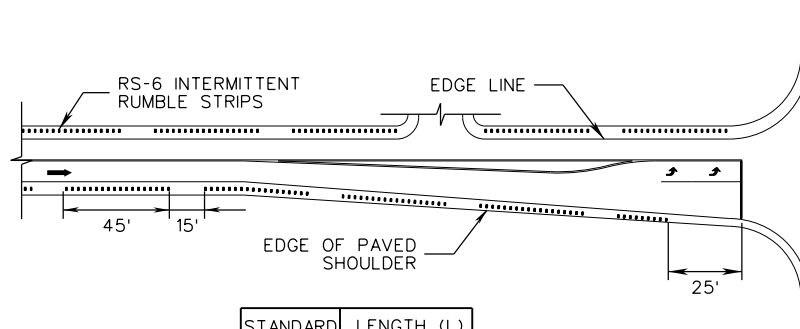




RS-6 MEDIAN, SECTION VIEW A-A



RS-6 OUTSIDE, SECTION VIEW A-A  
(SHOULDER WIDTH >=1'-6" AND <=3'-6")



PUBLIC ROADWAY OR COMMERCIAL ENTRANCE

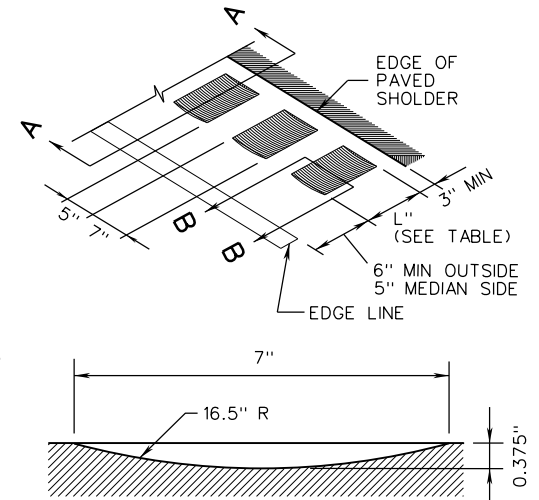
PLAN VIEW

STANDARD	LENGTH (L)
RS-6A	9"
RS-6B	12"

NOTES

- RUMBLE STRIP GROOVES ON THE OUTSIDE RIGHT SHOULDER SHALL BE MILLED-IN WITH INTERMITTENT PATTERN OF 45 FEET OF GROOVES FOLLOWED BY A 15-FOOT GAP AS SHOWN ON THE PLANS OR AS DIRECTED BY THE ENGINEER.
- RUMBLE STRIP GROOVES ON THE MEDIAN SHOULDER OF DIVIDED HIGHWAYS SHALL BE MILLED-IN CONTINUOUSLY AS SHOWN ON THE PLANS OR AS DIRECTED BY THE ENGINEER.
- RUMBLE STRIPS SHALL BE INSTALLED ON MAINLINE SHOULDERS ONLY, UNLESS DIRECTED BY DISTRICT TRAFFIC ENGINEER FOR RAMP.
- RUMBLE STRIPS SHALL NOT BE INSTALLED WITHIN THE LIMITS OF BRIDGES, DRAINAGE APRONS, RAIL GRADE CROSSINGS, OR MARKED CROSSWALKS, UNLESS DIRECTED BY THE ENGINEER.
- RUMBLE STRIPS SHALL NOT BE PLACED WITHIN 25 FEET OF ANY PUBLIC ROADWAY, COMMERCIAL DRIVEWAY, MEDIAN BREAK CROSSOVER TAPER OR TURN RADIUS; TURN LANE TAPER OR ACCELERATION/DECELERATION LANE; OR, WITHIN THE GORE AREA, GAPS FOR PRIVATE DRIVEWAYS ARE AT THE DISCRETION OF THE ENGINEER.
- THE WIDTH OF THE RUMBLE STRIPS SHALL BE SELECTED FROM THE STANDARD OPTIONS SPECIFIED IN THE TABLE ON THIS STANDARD SHEET. THE SPECIFIC WIDTH IS AT THE DISCRETION OF THE ENGINEER AND SHALL BE SPECIFIED IN THE CONTRACT DOCUMENTS.

- ALL MATERIAL MILLED TO FORM THE RUMBLE STRIP SHALL BE THOROUGHLY REMOVED, COLLECTED, AND DISPOSED OF IN A LOCATION APPROVED BY THE ENGINEER, AND SWEEPED CLEAN OF DUST.
- OVERSPRAY OF LIQUID ASPHALT COATING (EMULSION) SHALL NOT EXTEND MORE THAN 2 INCHES BEYOND THE WIDTH OF GROOVE AND/OR SHALL NOT COME IN CONTACT WITH PAVEMENT MARKINGS.
- PAVEMENT MARKINGS SHALL BE PLACED AT TIMES AND LOCATIONS IN ACCORDANCE WITH THE CURRENT VDOT STANDARDS, CONTRACT DOCUMENTS, THE VIRGINIA SUPPLEMENT TO THE MUTCD, AND AS DIRECTED BY THE ENGINEER.
- IF THERE ARE PAVEMENT JOINTS, OUTSIDE EDGE LINE SHOULD BE PLACED 2 INCHES FROM THE PAVEMENT JOINT AND MEDIAN EDGE LINE SHOULD BE PLACED 1-INCH FROM THE PAVEMENT JOINT, UNLESS APPROVED BY THE ENGINEER. THE PAVEMENT JOINT SHOULD BE WITHIN THE SHOULDER UNLESS APPROVED BY THE ENGINEER.



RUMBLE GROOVE SECTION B-B

SPECIFICATION REFERENCE

310  
315

A COPY OF THE ORIGINAL SEALED AND SIGNED DRAWING IS ON FILE IN THE CENTRAL OFFICE.

SHOULDER EDGE RUMBLE STRIPS

VIRGINIA DEPARTMENT OF TRANSPORTATION

VDOT

ROAD AND BRIDGE STANDARDS

REVISION DATE  
12/21

SHEET 1 OF 1

304.05

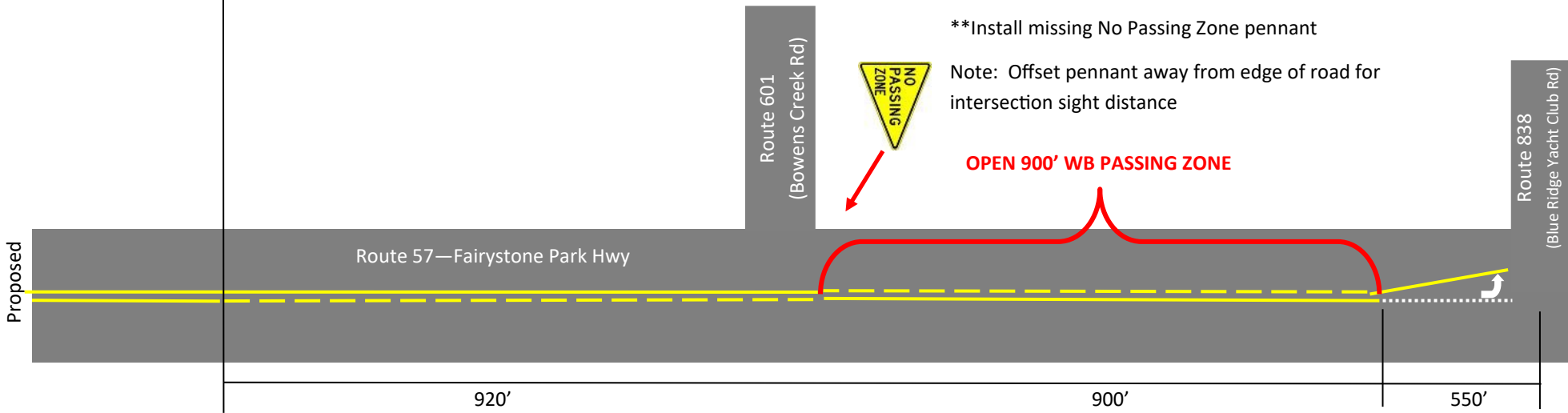
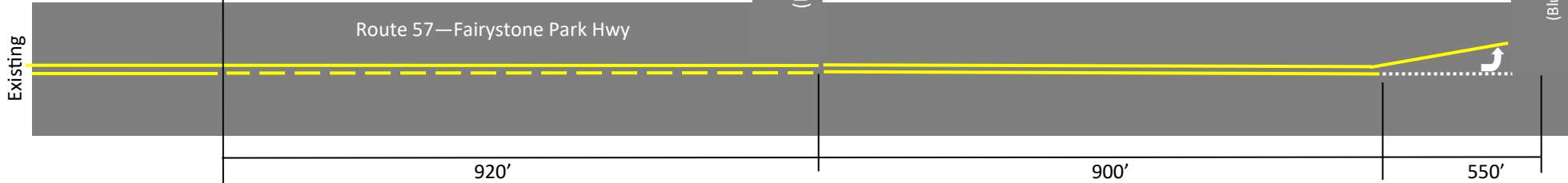
Passing Zone  
Co MP 1.08—4.00

# Henry County—ROUTE 57 (Fairystone Park Hwy)—Passing Zone Modification Sketch

Note: Speed limit is 55 MPH

← To Route 687—Stones Dairy Road

1.07 miles east of Route 687



← To Route 687—Stones Dairy Road



\*\*Install No Passing Zone pennant on back of Adopt-A-Highway sign (new post required)

\*\*Note: Contact Gary Bowman at 540-588-8835 two weeks prior to applying final pavement markings to install No Passing Zone pennants

NOT TO SCALE



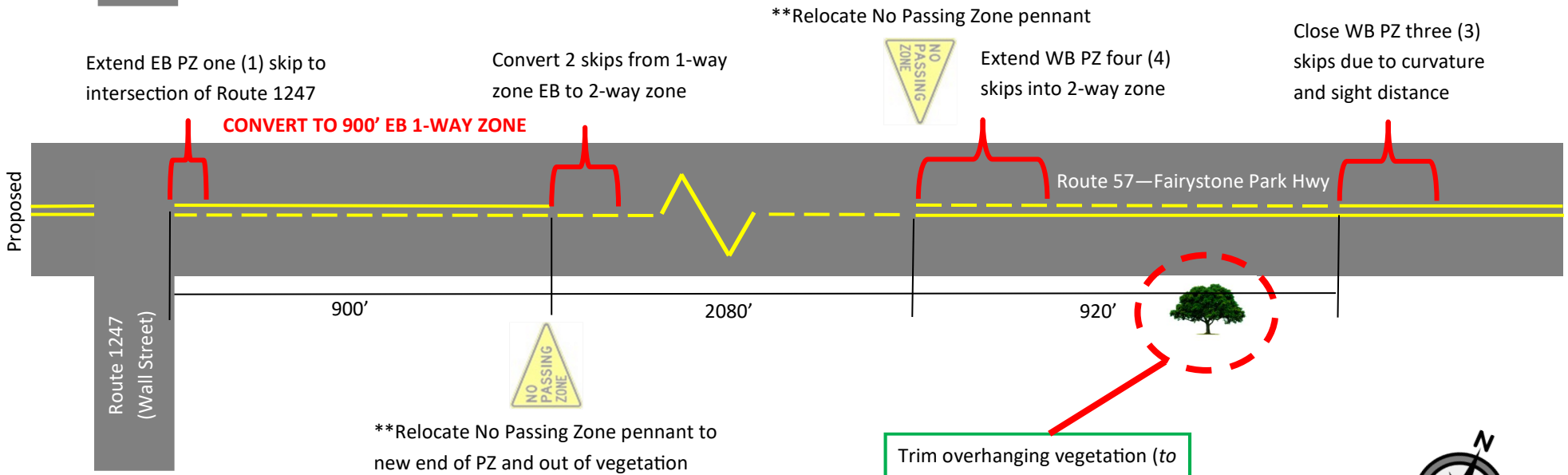
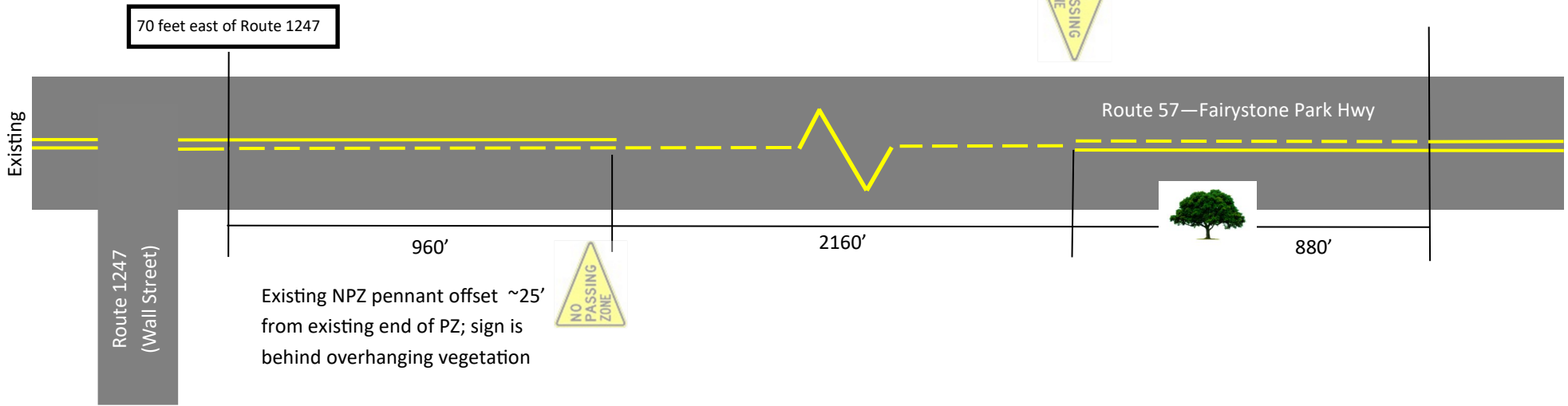
Passing Zone  
Co MP 1.08—4.00

# Henry County—ROUTE 57 (Fairystone Park Hwy)—Passing Zone Modification Sketch

Note: Speed limit is 55 MPH

<— To Route 838—Blue Ridge Yacht Club Road

To Route 942 —Spring Garden Lane —>



**\*\*Note: Contact Gary Bowman at 540-588-8835 two weeks prior to applying final pavement markings to relocate No Passing Zone pennants**

Trim overhanging vegetation (to be conducted by others)

NOT TO SCALE



Passing Zone  
Co MP 12.29—14.44

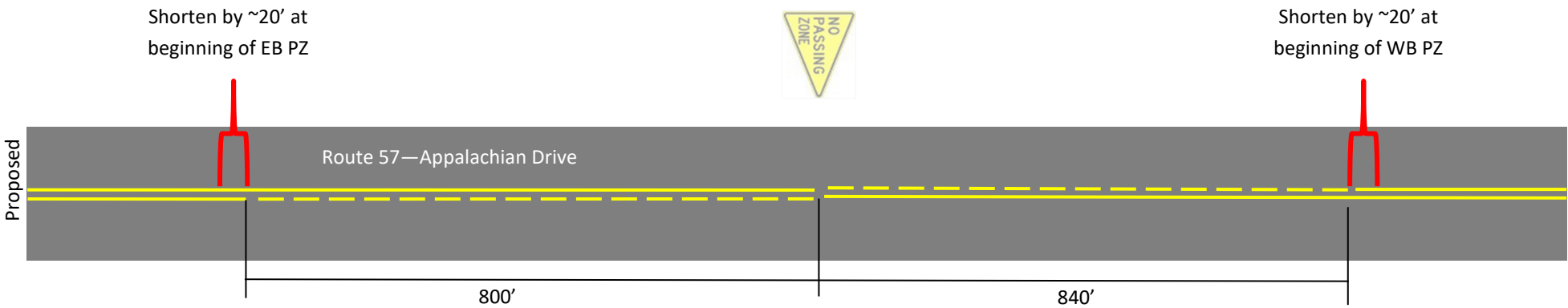
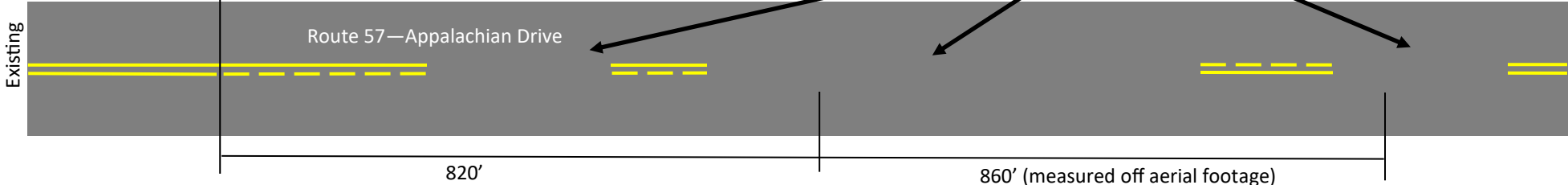
# Henry County—ROUTE 57 (Appalachian Drive)—Passing Zone Modification Sketch

Note: Speed limit is 50 MPH

← To Route 701—Field Ave

0.60 miles east of Route 701  
(Field Ave)

Existing asphalt pavement patches  
over centerline markings

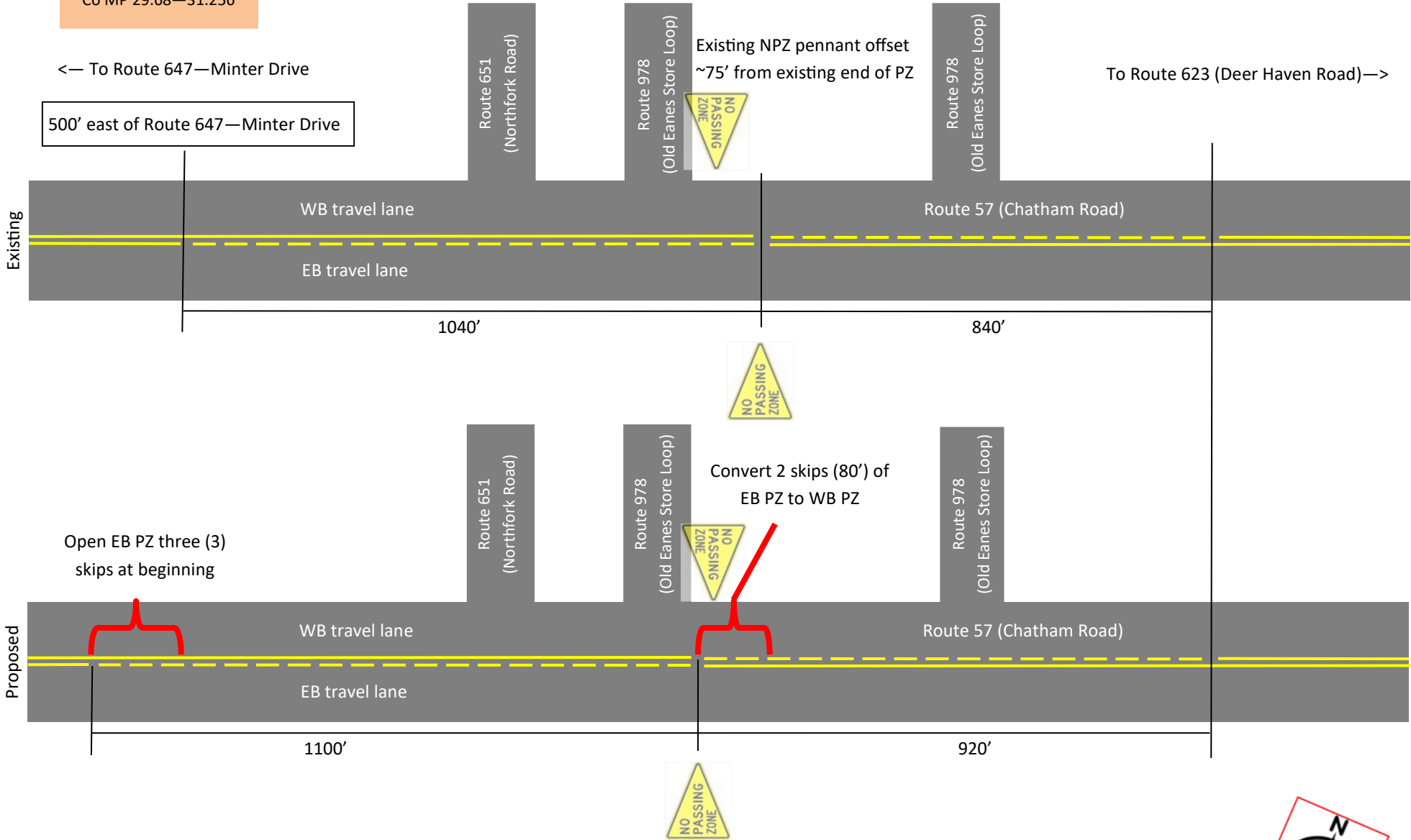


NOT TO SCALE

# Henry County—ROUTE 57 (Chatham Road)—Passing Zone Modification Sketch

Passing Zone  
Co MP 29.68—31.256

Note: Speed limit is **posted 55 MPH**



<— To Route 647—Minter Drive

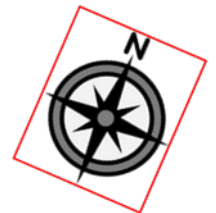
To Route 623 (Deer Haven Road)—>

500' east of Route 647—Minter Drive

\*\*Relocate "No Passing Zone" pennant as shown.

\*\*Note: Contact Gary Bowman at 540-588-8835 two weeks prior to applying final pavement markings to relocate No Passing Zone pennant.

NOT TO SCALE



# Henry County—ROUTE 57 (Chatham Road)—Passing Zone Modification Sketch

Passing Zone  
Co MP 29.68—31.256

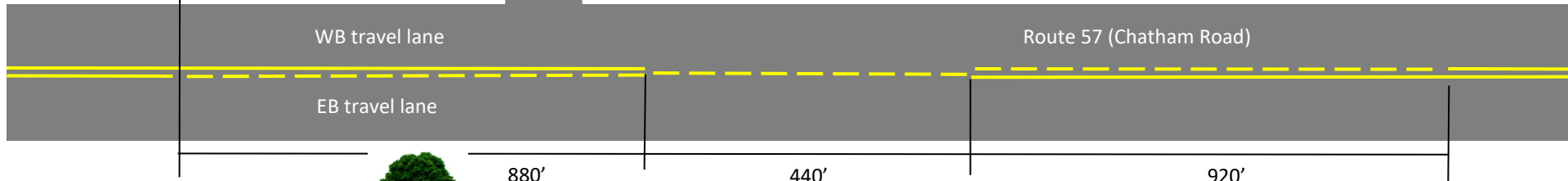
Note: Speed limit is posted 55 MPH

← To Route 978— East Int. — Old Eanes Store Loop

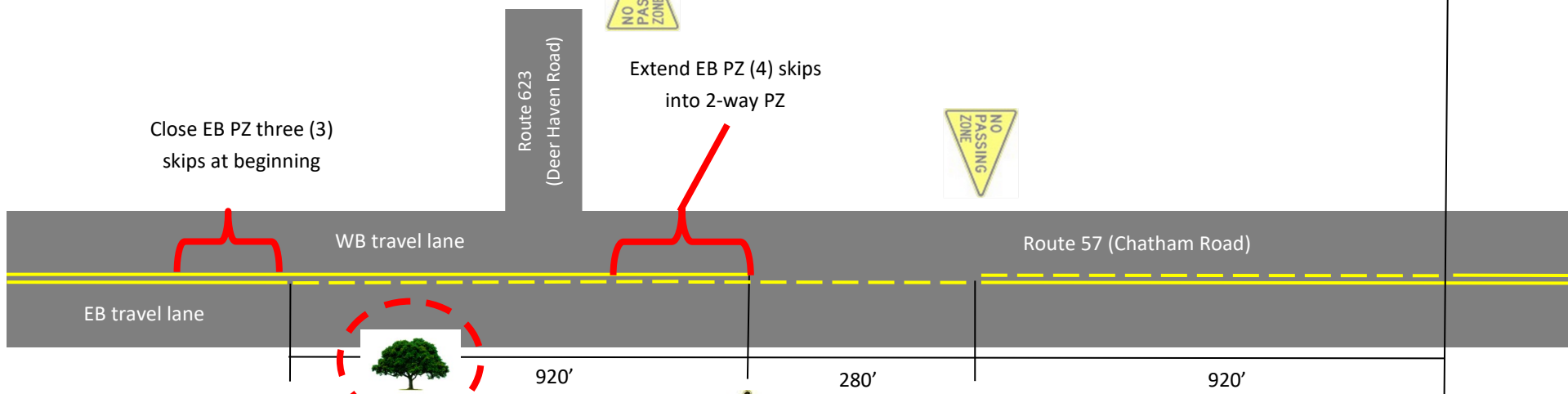
To Route 816 — Sharon Drive →

600' east of Route 978-East Int.  
(Old Eanes Store Loop)

Existing



Proposed



Close EB PZ three (3)  
skips at beginning

Extend EB PZ (4) skips  
into 2-way PZ

Trim overhanging vegetation (to  
be conducted by others)

\*\*Relocate WB "No Passing  
Zone" pennant as shown.

NOT TO SCALE



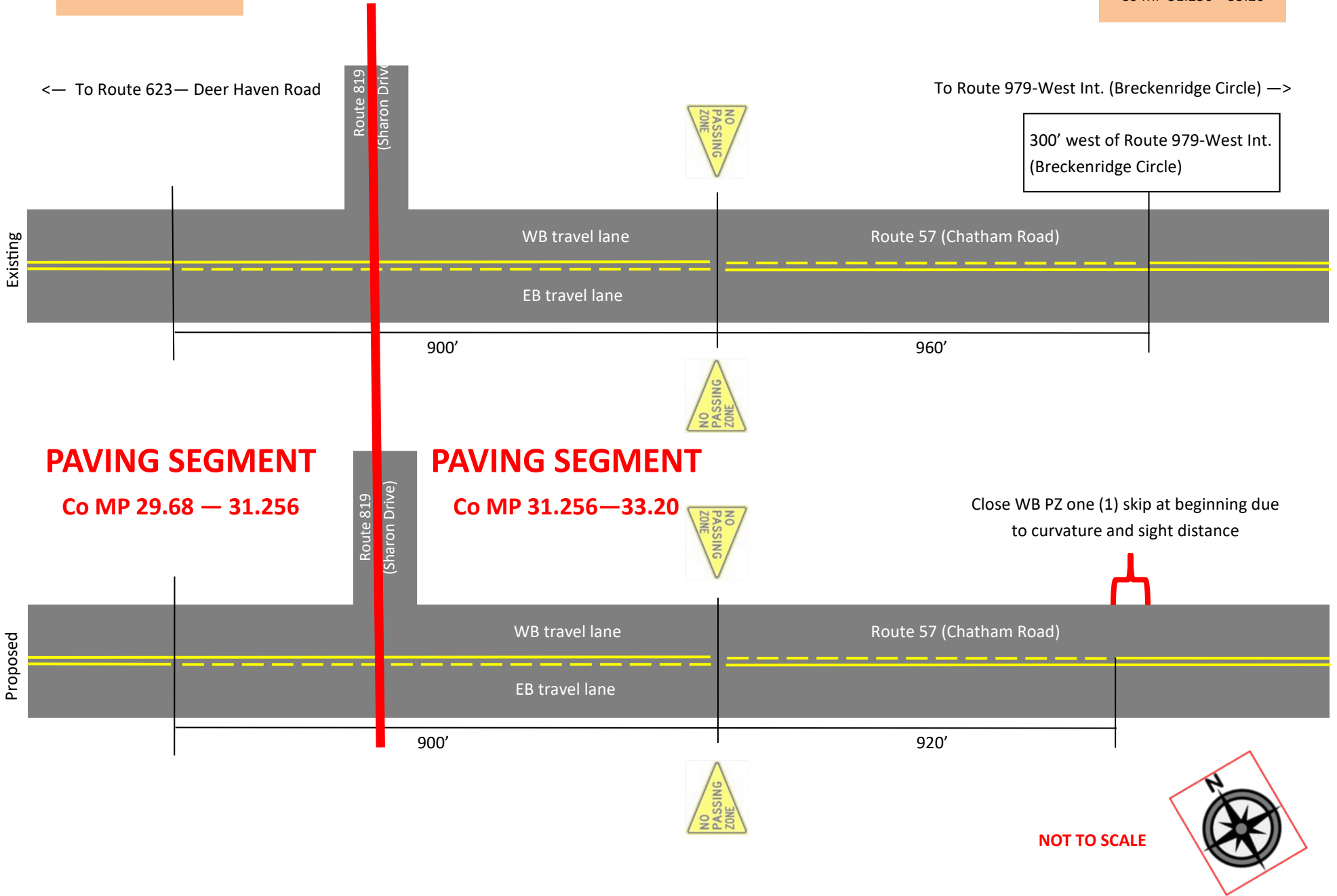
\*\*Note: Contact Gary Bowman at 540-588-8835 two weeks prior to applying final pavement markings to relocate No Passing Zone pennant.

Passing Zone  
Co MP 29.68—31.256

# Henry County—ROUTE 57 (Chatham Road)—Passing Zone Modification Sketch

Note: Speed limit is posted 55 MPH

Passing Zone  
Co MP 31.256—33.20



Passing Zone  
Co MP 31.256—33.20

# Henry County—ROUTE 57 (Chatham Road)—Passing Zone Modification Sketch

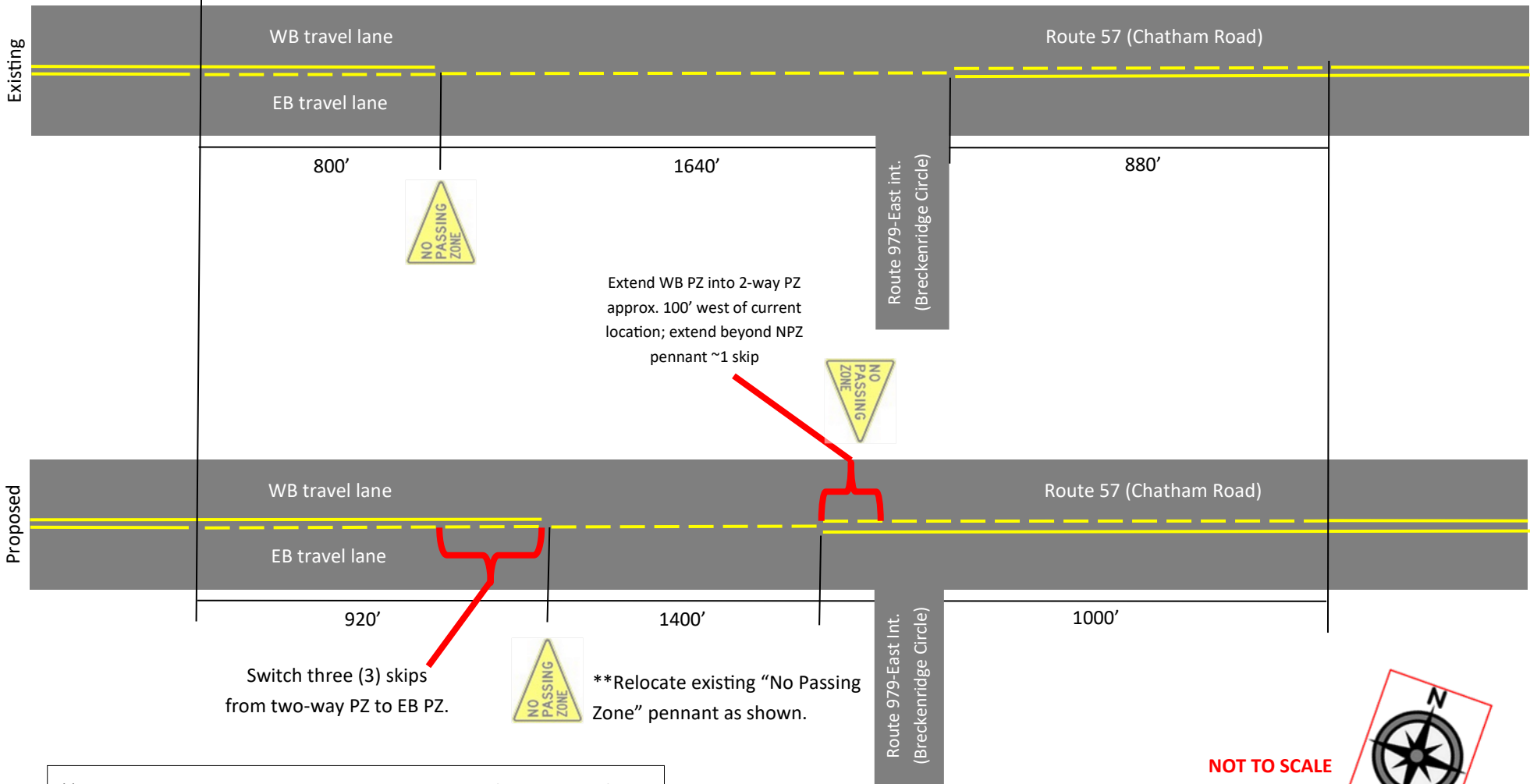
Note: Speed limit is **posted 55 MPH**

<— To Route 979-West Int. — Breckenridge Circle

To Pittsylvania County—>

800' east of Route 979-West Int.  
(Breckenridge Circle)

Existing NPZ pennant offset ~80'  
from existing end of 2-way PZ



Extend WB PZ into 2-way PZ  
approx. 100' west of current  
location; extend beyond NPZ  
pennant ~1 skip

Switch three (3) skips  
from two-way PZ to EB PZ.

\*\*Relocate existing "No Passing  
Zone" pennant as shown.

\*\*Note: Contact Gary Bowman at 540-588-8835 two weeks prior to applying final pavement markings to relocate No Passing Zone pennant.

NOT TO SCALE

